

Installation and Operation Manual

HyperDeck Shuttle

HyperDeck Studio



Welcome



Welcome to HyperDeck!

Welcome to HyperDeck!

We hope you share our dream for the television industry to become a truly creative industry by allowing anyone to have access to the highest quality video.

Our range of HyperDeck disk recorders have made it easier and more affordable than ever to capture and play back full 10-bit uncompressed video. HyperDeck records directly to removable 2.5" Solid State Disks (SSD's) that are getting bigger, faster and more affordable every day. It's incredible that you can now record the most amazing quality SD and HD video on to something so small, and record and play an SSD thousands of times without any degradation in quality!

You can bypass unwanted camera compression and record directly from HDMI or SDI cameras straight to SSD and even connect to any HDMI or SDI monitor for instant playback! SSD's can also be mounted on any computer for immediate editing and fast transfer of your media. With no moving parts, SSD's are unbelievably robust and can handle harsh conditions that would destroy conventional hard drives and videotapes!

If you need longer recording times for each SSD, then HyperDeck also records and plays back Avid DNxHD MXF files. This 10-bit quality high definition codec retains fantastic picture quality and increases the recording length of SSD's by more than 5 times!

This instruction manual contains all the information you need to start using your HyperDeck disk recorder. For uncompressed recording you need to use an SSD that supports the required data speed and we are continually adding details on our website of new SSD's that we have tested.

Please check the support page on our web site at www.blackmagic-design.com for the latest version of this manual and updates to the HyperDeck software. Keeping your software up to date will always ensure you get all the latest features. When downloading software, please register with your information so we can keep you updated when new software is released. We are constantly working on new features and improvements, so we would love to hear from you!

Grant Petty
CEO Blackmagic Design



4 Getting Started

Introducing HyperDeck	4
Important Information about SSD Speeds	5
Connecting SSD's to Your Computer	5
Preparing SSD's for use with HyperDeck	6
HyperDeck Shuttle	7
HyperDeck Studio	9
HyperDeck Utility	11
Installing HyperDeck Utility	11
Updating the Internal Software	11
Choosing a Recording Format	12

13 Using HyperDeck

Using HyperDeck Shuttle	13
How HyperDeck Shuttle Checks Your SSD	13
Accessing Your Clips	13
Recording Clips	13
How to Play Back	14
How to Shuttle	14
Using HyperDeck Studio	15
How HyperDeck Studio Checks Your SSD	15
Accessing Your Clips	15
Recording Clips using 1 and 2 SSD's	15
How to Play Back	16
RS-422 Machine Control	16
Using HyperDeck Studio with NLE Software	17
Avid Media Composer Presets	18
Genlock	19
How to Jog and Shuttle	19

20 Installing the HyperDeck Shuttle Mounting Plate

How to Install the HyperDeck Shuttle Mounting Plate	20
-----------------------------------------------------	----

21 Help

Getting Help	21
Blackmagic Design Online Support Pages	21
Contacting Blackmagic Design Support	21
Checking the Version Currently Installed	21
How to Get the Latest Updates	21

22 Developer Information

Supported RS-422 Commands for HyperDeck Studio	22
RS-422 Status Bytes for HyperDeck Studio	28

29 Warranty Information



4 Getting Started



HyperDeck Shuttle



HyperDeck Studio

Introducing HyperDeck

HyperDeck disk recorders record uncompressed SD and HD video quality directly to low cost solid state disks. Video playback can be viewed on an SDI or HDMI monitor or you can connect the SSD to a computer and edit directly from the SSD media itself. HyperDeck disk recorders have internal 3 Gb/s SATA ports which are used with standard 2.5" SSD's.

HyperDeck disk recorders have SDI and HDMI connectors making it easy to work with a huge range of professional and consumer video equipment. SDI and HDMI connectors also support embedded audio.

HyperDeck Shuttle is compact, affordable and battery powered so it's perfect as a field recorder. HyperDeck Shuttle bypasses your camera's compression and records from SDI and HDMI directly into the highest quality uncompressed video. The latest model can even record and play back in the DNxHD format if compressed video better suits your workflow or if you need to fit more video on an SSD.

HyperDeck Shuttle Mounting Plate can be purchased if you want to secure your HyperDeck Shuttle to a camera rig with your choice of rail mounts, cold shoe mounts, articulated arms and more. You can also use the plate to power your HyperDeck Shuttle from an external battery by attaching a V-Mount or Anton Bauer style battery plate.

When you need more than a field recorder, HyperDeck Studio features dual SSD slots and automatically continues recording onto the next SSD when one record disk fills. HyperDeck Studio features uncompressed video quality recording and playback, RS-422 deck control, genlock, jog and shuttle, an integrated LCD, and is affordable and easy to use. It can even record and play back in the DNxHD format if compressed video better suits your workflow or if you need to fit more video on an SSD. HyperDeck Studio is the broadcast deck for the 21st century!

HyperDeck Studio is rack-mountable and is only 1 RU high and less than 4 inches deep. It's the perfect size when space is tight such as in broadcast vans and fly away rack cases.

5 Getting Started



Important note about Solid State Disk (SSD) speeds

Some models of SSD cannot save video data at the speed indicated by the manufacturer because the disk uses hidden data compression to reach these higher write speeds. This data compression technique can only save data at the manufacturer's claimed speed when storing simple files or simple data, such as blank data. Video data includes video noise, and more random pixel data which does not compress much, so the true speed of the disk is seen.

Some SSD's can have up to 50% lower write speed than the manufacturer's claimed speed, so even though the disk specifications claim an SSD is fast enough to handle video, in reality the disk is not fast enough for real time video data capture. Hidden data compression mostly affects capture and often these disks can still be used for real time playback.

Use Blackmagic Disk Speed Test to measure accurately if your SSD will be able to handle uncompressed video capture and playback. Blackmagic Disk Speed Test uses data to simulate the storage of video so you get results similar to what you will see when capturing video to a disk. This will let you find models of SSD that work well for video capture. In our testing, we have found larger newer models of SSD, and larger capacity SSD's are generally faster. Blackmagic Disk Speed Test also tests the speed of disks connected to eSATA docks and other interfaces, which can affect disk performance. Please check our web site at www.blackmagic-design.com and click the support page to download the latest version of Blackmagic Disk Speed Test.

SSD's certified for use with HyperDeck and uncompressed video include the OCZ 240GB Vertex 3, Crucial 256GB C300, Kingston 64GB SSDNow V+ and Kingston 128GB SSDNow V+. Please check the tech notes on the Blackmagic Design web site for the latest information.

If you find an SSD which isn't fast enough for uncompressed HD video, try a faster SSD or use HyperDeck Utility to switch to a compressed recording format if supported by your HyperDeck model.

Connecting SSD's to Your Computer

In order to format an SSD, or to edit video files on an SSD, you will need to connect the SSD to a Mac or Windows computer. The SSD can most conveniently be connected to a computer using an external SATA dock with a high speed connection to the computer, such as eSATA or USB 3.0.

If you only need to format an SSD or transfer clips, a USB 2.0 to SATA dock will be adequate. An eSATA or USB 3.0 dock should be used for very fast clip transfers and editing clips directly from the SSD in real time.



6 Getting Started

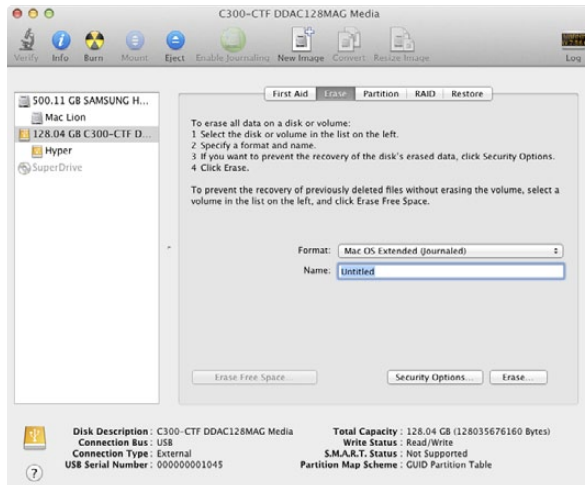

Use Disk Utility on Mac OS X to erase your SSD in the Mac OS Extended (Journaled) format.

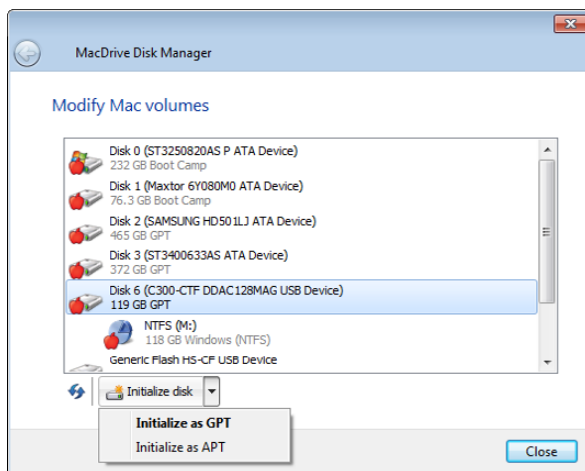

Use MacDrive software on Windows to initialize the SSD with a GPT and create an HFS+ volume.

Preparing SSD's for use with HyperDeck

SSD's used by HyperDeck must be HFS+ formatted. Simply connect the SSD to your computer via an external dock or cable adapter and format it as you would a regular disk. Make sure you check there's nothing important on your SSD as you will lose everything on it when you format it.

Preparing SSD's on a Mac OS X computer

The Disk Utility application included with Mac OS X will format a drive in the Mac OS X Extended (Journaled) format, which is also known as HFS+.

- Step 1.** Connect the SSD to your computer and dismiss any message offering to use your SSD for Time Machine backups.
- Step 2.** Go to /Applications/Utilities and launch Disk Utility.
- Step 3.** Click on the disk icon of your SSD and then click the Erase tab.
- Step 4.** Set the Format to "Mac OS Extended (Journaled)", type a Name for the new volume and then click Erase. Your SSD will quickly be formatted and made ready for use with HyperDeck.

Preparing SSD's on a Windows computer

If you're using a Windows PC, use MacDrive software to create and read HFS+ formatted disks. MediaFour MacDrive can be purchased online from <http://www.mediafour.com>.

- Step 1.** Install MediaFour MacDrive and restart your PC.
- Step 2.** Connect the SSD to your computer.
- Step 3.** Choose Start>Computer and right-click on your SSD.
- Step 4.** From the contextual menu, choose MacDrive>Format Mac Disk.
- Step 5.** Select the SSD in the MacDrive Disk Manager and choose Initialize disk>Initialize as GPT.
- Step 6.** Choose "Automatically create an HFS+ volume" and click "Initialize Disk".
- Step 7.** Once the format has been completed, close out of the MacDrive Disk Manager. Your SSD is ready for use with HyperDeck.

7 Getting Started

HyperDeck Shuttle

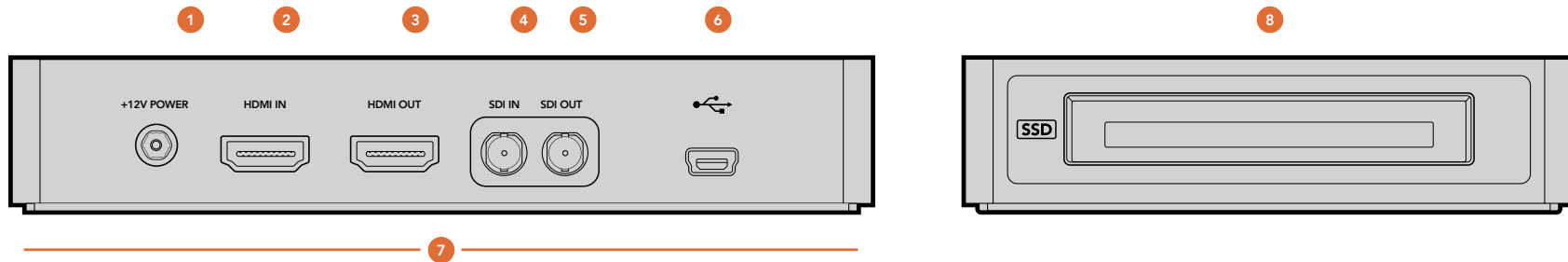

Connectors

1. +12V POWER

You can use the power adapter supplied with HyperDeck Shuttle or power it off an external camera battery as the connector supports an input range of 12V to 18V. When a power source is connected, the built-in internal battery will also be charged.

2. HDMI IN

You can connect your HDMI video sources to this input – such as a camera, games console and the output of an ATEM switcher.

3. HDMI OUT

Connect an HDMI display or TV to this output to monitor your video while recording or playing back clips. You can also connect this output to the HDMI input of capture cards, production switchers and other recording devices.

4. SDI IN

You can connect your SDI video sources, such as cameras, routers, capture cards, switcher outputs or decks to this input. A DIN 1.0/2.3 miniature connector is used for SDI input. A short DIN 1.0/2.3 to BNC adapter cable can be used to connect to SDI cables with BNC connectors.

5. SDI OUT

Connect this output to monitors, routers, production switchers, decks or other recording devices. A DIN 1.0/2.3 miniature connector is used for SDI output. A short DIN 1.0/2.3 to BNC adapter cable can be used to connect to SDI cables with BNC connectors.

6. USB 2.0

Use the USB Mini-B port for software configuration and updates.

Mounts

7. Rubber Mat or HyperDeck Shuttle Mounting Plate

HyperDeck Shuttle has a non-slip rubber base for use on a desk. If you want to mount HyperDeck Shuttle on a camera or tripod, the base can be removed and replaced with an optional HyperDeck Shuttle Mounting Plate that is available for purchase from Blackmagic Design resellers.

SSD Slot

8. SSD Slot

Insert a 2.5" SSD in to the SSD slot until you feel the SSD press in to place. Hard drives are not supported and should not be used. To remove the SSD, simply pull it out.

8 Getting Started

HyperDeck Shuttle

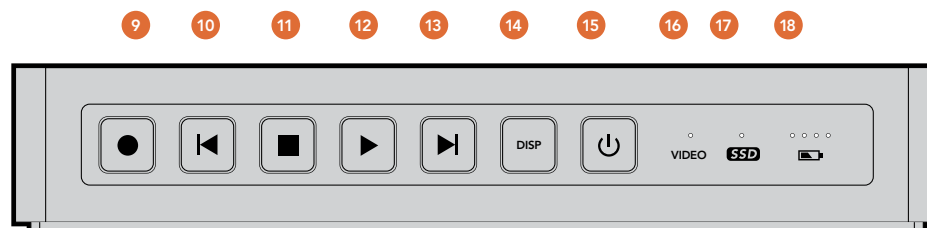

Buttons

9. Record

HyperDeck Shuttle will instantly record the moment you press the Record button, even if you're playing back a clip. This means you'll never miss a good take that's happening. If the button flashes red, the SSD is too slow and is dropping frames.

10. Previous Clip

If you hold down the Previous Clip, the clip will reverse at 2x speed. Pressing the button again will increase the speed to 4x and 8x. If you want to resume playing back at normal speed, just press the Play button. Or you can press the Stop button to pause when reversing.

11. Stop

The Stop button also switches HyperDeck Shuttle between playback and video loop through mode.

12. Play

When a clip is playing, pressing Play again will loop it continuously.

13. Next Clip

If you hold down Next Clip, the clip will fast forward at 2x speed. Pressing the button again will increase the speed to 4x and 8x. If you want to resume playing back at normal speed, just press the Play button. Or you can also press the Stop button to pause when fast forwarding.

14. DISP

This button isn't currently used but will soon be enabled by a software update. You will be able to download this for free at www.blackmagic-design.com

15. Power On/Off

The Power button turns the HyperDeck Shuttle on or off. To prevent someone from accidentally switching off the unit, you must hold the Power button down for 2 seconds to turn it off. If you're running off the built-in batteries, the unit will turn itself off to conserve power after 8 minutes if you're not recording.

Status Indicators

16. VIDEO

The VIDEO indicator lights up when a video signal is detected by HyperDeck Shuttle.

17. SSD

The SSD indicator lights up in green when it is accessing a correctly formatted SSD. If the SSD has not been formatted correctly, or fails to work, the SSD light will illuminate solid red until the SSD is removed.

18. Battery

The four green battery indicators display the internal battery charge level. When all the LEDs go off, there's approximately 4 minutes of battery power left. So you should plug in your external power source or switch to another charged HyperDeck Shuttle.

9 Getting Started

HyperDeck Studio

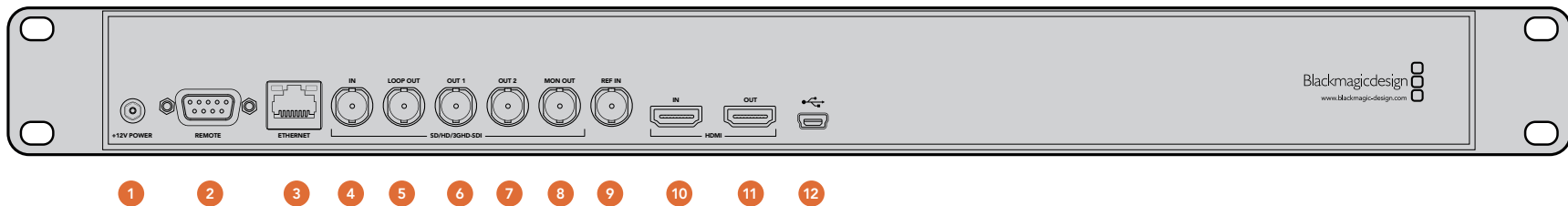

Connectors

1. +12V POWER

You can use the universal power adapter supplied with HyperDeck Studio or power it off any DC power source, from 12V to 18V, allowing for portable battery packs and on set use.

2. REMOTE

RS-422 remote control.

3. ETHERNET

This port isn't currently used but will soon be enabled by a software update.

4. SD/Hd-SDI IN

You can connect your SD/Hd-SDI video sources, such as cameras, routers, capture cards, switcher outputs or decks to this input.

5. SD/Hd-SDI LOOP OUT

This output is relocked from the video input and can be connected to other devices such as a monitor or a second HyperDeck for redundant recording.

6. SD/Hd-SDI OUT 1

Connect this output to monitors, routers, capture cards, production switchers, decks or other recording devices.

7. SD/Hd-SDI OUT 2

Connect this output to monitors, routers, production switchers, decks or other recording devices.

8. SD/Hd-SDI MON OUT

SD/Hd-SDI output for monitoring.

9. REF IN

This input accepts blackburst and tri-level sync signals from a sync generator.

10. HDMI IN

You can connect your HDMI video sources to this input – such as a camera, games console or the output of an ATEM switcher.

11. HDMI OUT

Connect an HDMI display or TV to this output to monitor your video while recording or playing back clips. You can also connect this output to the HDMI input of capture cards, production switchers and other recording devices.

12. USB 2.0

Use the USB Mini-B port for software configuration and updates.

10 Getting Started

HyperDeck Studio

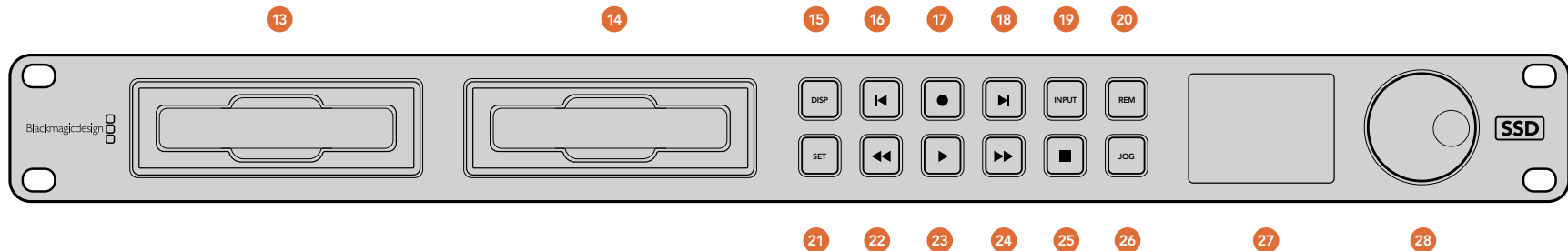

SSD Slots

13. SSD Slot 1

14. SSD Slot 2

Insert a 2.5" SSD in to an SSD slot until you feel the SSD press in to place. The surround of the SSD slot lights in green when it is accessing a correctly formatted SSD. If the SSD has not been formatted correctly, or fails to work, the SSD slot light will illuminate solid red until the SSD is removed. Hard drives are not supported and should not be used. To remove the SSD, simply pull it out.

Buttons and Controls

15. DISP

This button isn't currently used but will soon be enabled by a software update.

16. Previous Clip

Press once to go to the start of the current clip or press twice to skip back to the start of the previous clip.

17. Record

Recording commences the instant you press the record button, even if you're playing back a clip, so you'll never miss a good take that's happening. If the button flashes red, the

SSD is too slow and is dropping frames. To switch from one SSD to the other while recording, press the record button for 1 second.

18. Next Clip

Press to skip to the next clip.

19. INPUT

While the stop button is illuminated, press the INPUT button once to display the incoming video on the LCD. If you don't see the video you want, press the button again to switch between the HDMI and SDI inputs.

20. REM

Push REM to enable RS-422 remote control.

21. SET

This button isn't currently used but will soon be enabled by a software update.

22. Reverse

Press once to play in reverse at normal speed. Press again to reverse at 2x, 4x and 8x speeds.

23. Play

Press once to play through all clips or press again to loop the current clip.

24. Fast Forward

Press once to play at 2x speed or press again to play at 4x and 8x speeds.

25. Stop

Stop works in all modes.

26. JOG

Press once to use the jog wheel to scroll through video or press again to set the jog wheel to shuttle mode.

27. LCD

The color LCD displays video format, timecode, audio meters, video preview, transport controls and the active SSD.

28. Jog/Shuttle Wheel

Use with the JOG button to jog or shuttle forwards and backwards.

11 Getting Started

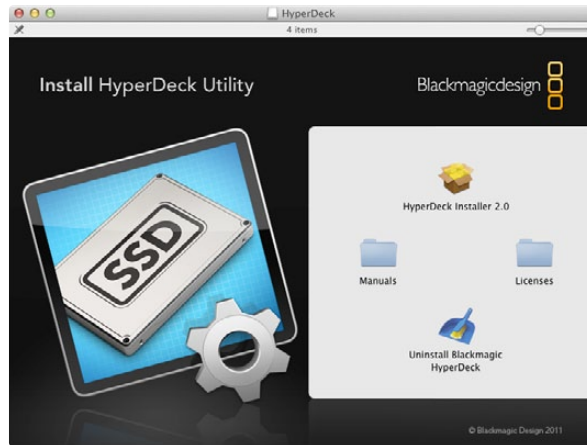

Blackmagic HyperDeck Utility

Blackmagic HyperDeck Utility is used to change settings and update the internal software in your HyperDeck. In addition to installing HyperDeck Utility, uncompressed 10 bit codecs are installed for Mac and Windows. If you use Avid Media Composer 6, you'll also find a HyperDeck Studio deck preset is installed to help with RS-422 deck control.

Installing Blackmagic HyperDeck Utility on Mac OS X

After downloading the HyperDeck Utility software and unzipping the downloaded file, open the resulting disk image to reveal its contents.

Launch the HyperDeck Installer and follow the on screen instructions.

To remove Blackmagic HyperDeck Utility from your Mac, open the HyperDeck Installer disk image and launch the Uninstall Blackmagic HyperDeck Utility. Follow the on screen instructions to remove the software.

Installing Blackmagic HyperDeck Utility on Windows

After downloading the HyperDeck Utility software and unzipping the downloaded file, you should see a HyperDeck Utility folder containing this PDF manual and the HyperDeck Utility installer.

Double-click the installer and follow the onscreen prompts to complete the installation.

To remove Blackmagic HyperDeck Utility from Windows 7, go to the Programs and Features control panel, select Blackmagic HyperDeck Utility and click on Uninstall.

Updating the Internal Software

After installing Blackmagic HyperDeck Utility on your computer, connect a USB cable between the computer and the HyperDeck. Launch Blackmagic HyperDeck Utility and follow any onscreen prompt to update the internal software in your HyperDeck. If no prompt appears, the internal software is up to date and there is nothing further you need to do.

12 Getting Started

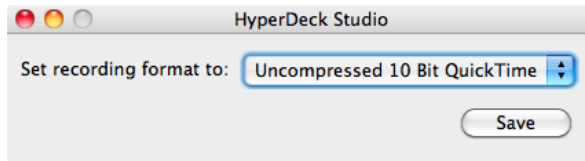

Choosing a Recording Format

HyperDeck Studio, and the latest model of HyperDeck Shuttle, let you select from a choice of uncompressed and compressed recording formats. Working with uncompressed video is exciting as there is no better quality than uncompressed. However if compressed video better suits your workflow, or if you need to fit more video on an SSD, you can choose a high quality professional compressed codec which is also perfect for editing.

- Step 1.** Connect HyperDeck to your computer via USB and launch HyperDeck Utility.
- Step 2.** Launch HyperDeck Utility.
- Step 3.** Set the recording format to the desired codec from the pulldown menu and save the setting. You can now disconnect the USB cable if you wish.

All subsequent clips will be captured in the compressed format. If you want to switch back to uncompressed video, repeat the procedure and choose "Uncompressed 10 Bit" from the pulldown menu.

Setting the recording format also sets the playback format so you will only be able to play back clips that match the current recording format. Any other clips will be hidden which helps prevent slow SSD's from being accidentally used to play back high data rate uncompressed clips which they might not be fast enough to play.

Can My HyperDeck Shuttle Record to a Compressed Format?

The original HyperDeck Shuttle exclusively records in an uncompressed recording format. The HyperDeck Shuttle 2 can record to uncompressed and compressed recording formats. To check if you have a HyperDeck Shuttle 2, connect the HyperDeck unit via USB and then launch the latest version of the HyperDeck utility. The title bar of the HyperDeck Utility will report either HyperDeck Shuttle 2 or HyperDeck Shuttle. If it reports a HyperDeck Shuttle 2, then the menu options to set the recording format should also be available. These options will remain grayed out and unavailable with the original HyperDeck Shuttle.

13 Using HyperDeck



Using HyperDeck Shuttle

How HyperDeck Shuttle Checks Your SSD

When you first switch on HyperDeck Shuttle, or any time you insert an SSD in to the SSD slot, the SSD indicator will light in green while checking the SSD and then switch off. If the SSD has not been formatted correctly, or fails to work, the SSD indicator will illuminate solid red until the SSD is removed. Refer to the section "Preparing SSD's for use with HyperDeck" to check if the SSD is formatted correctly and also that it works with a computer.

Accessing Your Clips

HyperDeck Shuttle captures uncompressed clips in QuickTime format and the latest model also offers the choice of capturing clips in uncompressed or compressed formats. The "Choosing a Recording Format" section of this manual describes how to use Blackmagic HyperDeck Utility to switch between uncompressed and compressed recording formats. You'll also need to install the HyperDeck Utility software to install codecs to use the clips in your favorite video software.

Uncompressed clips are captured in the QuickTime format which requires QuickTime™ be installed on your computer. QuickTime for Mac is built into Mac OS X™. QuickTime for Windows™ can be downloaded free from Apple's website at <http://www.apple.com/quicktime/download/>.

Compressed high definition clips are captured to MXF files in the DNxHD format which can be used with Avid Media Composer on Mac OS X and Windows.

Recording Clips

- Step 1.** Format a certified SSD in the HFS+ format. See the "Preparing SSD's for use with HyperDeck" section for details.
- Step 2.** Turn on the HyperDeck Shuttle.
- Step 3.** Insert the HFS+ formatted SSD into HyperDeck Shuttle. As it reads the disk, the SSD light on the unit will illuminate. When the light goes off, HyperDeck Shuttle is ready to record.
- Step 4.** Connect your video source to the HyperDeck Shuttle's input. It doesn't matter if you use the HDMI or SDI input, as HyperDeck Shuttle will automatically detect which one is connected. You can also connect the video output of the HyperDeck Shuttle to your HDMI or SDI monitor. All outputs are active so you can use either one connection or both SDI and HDMI outputs together.
- Step 5.** If you see the Video status LED light up, it means that HyperDeck Shuttle has detected a valid video input.

Step 6. If you don't see your source video on the output, press the Stop button to switch HyperDeck Shuttle between video input loop through and playback.

Step 7. Press the Record button and HyperDeck Shuttle will start recording instantly. The SSD light will also flash to indicate the SSD activity. Once you've finished recording, press the Stop button.

If the Stop button starts flashing while recording, there are only 3 minutes of recording time left on the SSD. Make sure you have another empty SSD ready so you don't miss the next take.

How to Play Back

Playing back a clip is simple and instantaneous. If you're recording, press the Stop button once to stop recording. Press it again to switch to playback. Then simply press Play.

The controls of HyperDeck Shuttle work just like a CD player so pressing next clip will skip to the start of the next clip and continue playing. Press previous clip once to go to the start of the current clip or press twice to skip back to the start of the previous clip.

HyperDeck Shuttle can record 10 bit uncompressed QuickTime files on a fast SSD, or to a compressed format if you have a slower SSD or want to fit longer high definition recordings on a single SSD. This means it is possible to have uncompressed QuickTime files as well as compressed files on the same disk if you have used the HyperDeck Utility software to change the recording format.

Setting the recording format also sets the playback format so you will only be able to play back clips that match the current recording format. Any other clips will be hidden which helps prevent slow SSD's from being accidentally used to play back high data rate uncompressed clips which they might not be fast enough to play.

How to Shuttle

If you're reviewing a long clip and need to quickly shuttle to a particular section, just hold down the Previous Clip or Next Clip button. This will allow you to reverse or fast forward through the clip at 2x speed. To go faster, press the Previous Clip or Next Clip button again and the speed will increase to 4x and then 8x. Once you've found the section you want to review, press Play and playback will resume at normal speed.

15 Using HyperDeck



Using HyperDeck Studio

How HyperDeck Studio Checks Your SSD

When you first switch on HyperDeck Studio, or any time you insert an SSD in to an SSD slot, the surround of the SSD slot will light in green while checking the SSD and then switch off. If the SSD has not been formatted correctly, or fails to work, the SSD slot light will illuminate solid red until the SSD is removed. Refer to the section "Preparing SSD's for use with HyperDeck" to check if the SSD is formatted correctly and also that it works with a computer.

Accessing Your Clips

HyperDeck Studio offers the choice of capturing clips in uncompressed or compressed formats. The "Choosing a Recording Format" section of this manual describes how to use Blackmagic HyperDeck Utility to switch between uncompressed and compressed recording formats. You'll also need to install the HyperDeck Utility software to install codecs to use the clips in your favorite video software.

Uncompressed clips are captured in the QuickTime format which requires QuickTime™ be installed on your computer. QuickTime for Mac is built into Mac OS X™. QuickTime for Windows™ can be downloaded free from Apple's website at <http://www.apple.com/quicktime/download/>.

Compressed high definition clips are captured to MXF files in the DNxHD format which can be used with Avid Media Composer on Mac OS X and Windows.

Recording Clips using 1 and 2 SSD's

Before recording, use HyperDeck Utility to choose an uncompressed or compressed recording format.

- Step 1.** Connect a power supply to HyperDeck Studio. You can use the universal power adapter supplied with HyperDeck Studio or power it off any DC power source, from 12V to 18V, allowing for portable battery packs and on set use.
- Step 2.** Format a certified SSD in the HFS+ format. See the "Preparing SSD's for use with HyperDeck" section for details.
- Step 3.** Insert the HFS+ formatted SSD into either SSD slot of HyperDeck Studio. As it reads the disk, the SSD slot light will illuminate solid green. When the light goes off, HyperDeck Studio is ready to record. If the SSD has not been formatted correctly, or fails to work, the SSD slot light will illuminate solid red until the SSD is removed.
- Step 4.** Connect your video source to an HyperDeck Studio input. Press the INPUT button once, while the stop button is illuminated, to preview the video source on the LCD before recording. If you don't see the video you want, press the button again to switch between the HDMI and SDI inputs.



16 Using HyperDeck

- Step 5.** Connect the video outputs of HyperDeck Studio to your HDMI or SDI monitor and other equipment. All outputs are active so you can use one or more outputs together.
- Step 6.** Press the record button to start recording to the SSD instantly. The SSD slot light will illuminate with a looping red light to indicate it is being used for recording.
- Step 7.** If you don't see your source video on the output, press the Stop button to switch HyperDeck Shuttle between video input loop through and playback.
- Step 8.** If the first SSD runs out of space before recording has finished, recording will automatically continue on the second SSD if present. Remove the first SSD and replace with an empty SSD for continued recording.

If an SSD is running out of space, and a second SSD is not ready to record, the timecode in the LCD will become red and a 5 minute countdown will show the remaining recording time. Press the stop button to finish recording.

How to Play Back

Playing back a clip is simple and instantaneous. The controls of HyperDeck Studio work just like a CD player so pressing next clip will skip to the start of the next clip and continue playing. Press previous clip once to go to the start of the current clip or press twice to skip back to the start of the previous clip. If you're recording, press the play button once for instant playback.

HyperDeck Studio can record 10 bit uncompressed QuickTime files on a fast SSD, or to a compressed format if you have a slower SSD or want to fit longer high definition recordings on a single SSD. This means it is possible to have uncompressed QuickTime files as well as compressed files on the same disk if you have used the HyperDeck Utility software to change the recording format.

Setting the recording format also sets the playback format so you will only be able to play back clips that match the current recording format. Any other clips will be hidden which helps prevent slow SSD's from being accidentally used to play back high data rate uncompressed clips which they might not be fast enough to play.

RS-422 Machine Control

HyperDeck Studio features an industry standard, Sony™ compatible, RS-422 deck control port which has the correct pin connections for a direct connection to any capture device with RS-422, such as any DeckLink card, Multibridge or UltraStudio.

You can use pre-manufactured 9 pin cables as long as each end of the cable are wired "pin for pin" where the same pin number on each end of the cable are connected together. If you would like to make custom cables, e.g. for extra length, please refer to the accompanying wiring diagram.

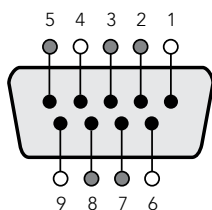

Receive (-)	Receive (+)	Transmit (-)	Transmit (+)	Ground Pins
2	7	8	3	1, 4, 6, 9

RS-422 remote pin connections.

17 Using HyperDeck

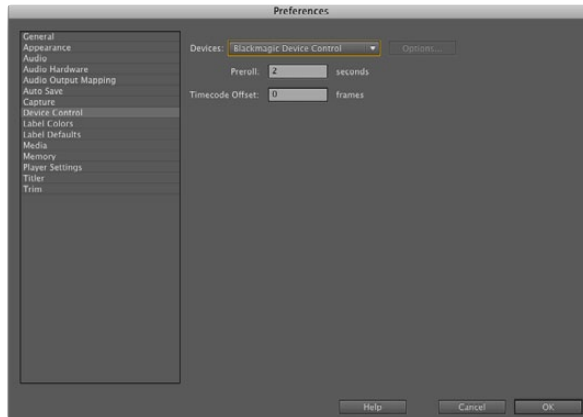

Device Control in Adobe Premiere Pro is usually provided by the driver software for your video capture hardware and is enabled in Preferences > Device Control.



Device Control in Apple Final Cut Pro 7 is usually provided by the driver software for your video capture hardware and is enabled when you choose an associated Easy Setup.

You can remotely control HyperDeck Studio from a computer, instead of locally pushing buttons.

Step 1. Connect an RS-422 cable between your capture device and HyperDeck Studio.

Step 2. Press the REM button to enable remote deck control.

You can now use your favorite NLE software, along with video capture hardware, to remotely capture, batch capture and play back video with your HyperDeck Studio.

Using HyperDeck Studio with NLE Software

Any non-linear editing software that supports video capture hardware, and RS-422 remote control, can be used to capture, batch capture and play back video from HyperDeck Studio with frame accuracy. The RS-422 deck control functionality in your NLE software might be provided by the software itself or might only appear when you install the driver software for your video capture hardware.

Adobe Premiere Pro CS5.x

Create a project in Adobe Premiere Pro by following the documentation that accompanied your video capture hardware. Device Control in Adobe Premiere Pro is usually provided by the driver software for your video capture hardware and is enabled in Preferences > Device Control. If you don't see any option for RS-422 device control, quit out of Premiere Pro and reinstall the software drivers for your video capture hardware. Launch Premiere Pro again and the RS-422 device control option should now appear in Preferences > Device Control.

Apple Final Cut Pro 7

Create a project in Apple Final Cut Pro 7 by following the documentation that accompanied your video capture hardware. Device Control in Apple Final Cut Pro 7 is usually provided by the driver software for your video capture hardware and is enabled when you choose an associated Easy Setup. You can check the RS-422 configuration in Final Cut Pro > Audio Video Settings and then click on the Device Control Presets tab. If you don't see an RS-422 device control preset for your capture hardware, quit out of Final Cut Pro and reinstall the software drivers for your capture hardware. Launch Final Cut Pro again and the RS-422 device control presets should now appear in the Device Control Presets tab.

Apple Final Cut Pro X

Apple Final Cut Pro X does not support RS-422 device control and so cannot remotely control HyperDeck Studio. However any QuickTime files recorded by HyperDeck Studio are fully compatible and can be imported in to Final Cut Pro X. When working with 10-bit uncompressed QuickTime movies, we recommend creating a new project in Final Cut Pro X with the Audio and Render Properties set to Custom. This will allow you to set the Render Format to Uncompressed 10-bit 4:2:2 which will avoid compression.

18 Using HyperDeck

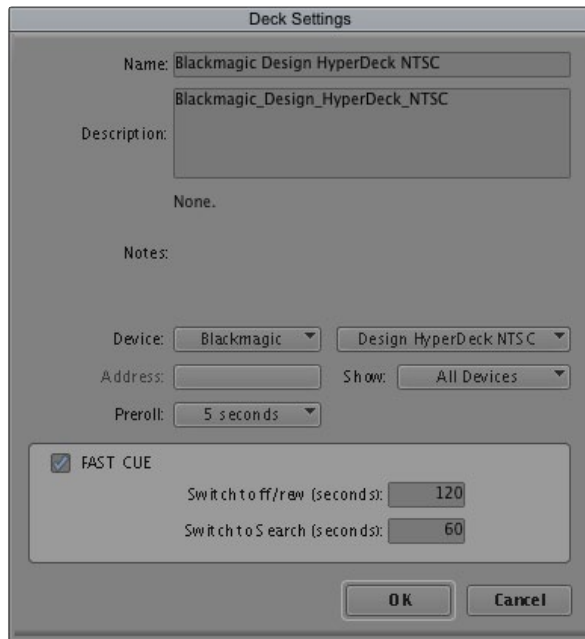

HyperDeck Studio deck presets are provided for SD and HD video resolutions when the HyperDeck Utility software is installed.

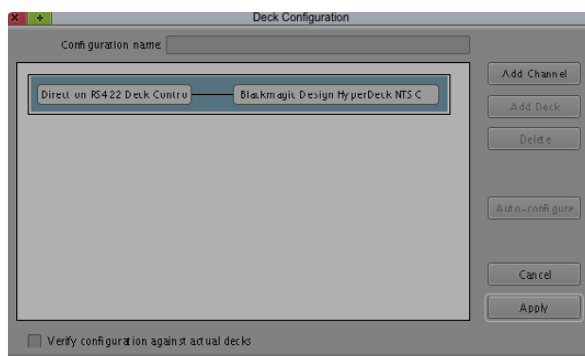

Device Control in Avid Media Composer 6 is provided by Media Composer itself and is configured via the Settings tab in your project window.

Avid Media Composer 6

Create a project in Avid Media Composer 6 by following the documentation that accompanied your video capture hardware. Device Control in Media Composer 6 is provided by Media Composer itself and is configured via the Settings tab in your project window. HyperDeck Studio deck presets are provided for SD and HD video resolutions when the HyperDeck Utility software is installed.

Before using Avid Media Composer 6 to remotely control HyperDeck Studio via RS-422, you will need to install the HyperDeck Utility software and then configure the deck settings in Media Composer.

- Step 1.** From your project window, click the Settings tab and double-click on Deck Configuration.
- Step 2.** In the Deck Configuration dialog box, click Add Channel and then set the Channel Type to Direct and the Port to RS-422 Deck Control. Click OK and choose "No" when asked, "Do you want to autoconfigure the channel now?"
- Step 3.** Click Add Deck and choose a Blackmagic Design HyperDeck preset from the Device menus. Preroll is not required by HyperDeck Studio and can just be left on the default setting. Click OK and then Apply.

To test the RS-422 connection, ensure an RS-422 serial cable is connected between your video capture hardware and HyperDeck Studio. The REM button must be pressed and illuminated on HyperDeck Studio so you can use the transport controls in Media Composer. Open the Capture Tool and use the standard j, k, l shortcut keys to shuttle backwards, pause and shuttle forwards on the deck. If the deck name "HyperDeck Studio" appears in italics in the Deck Selection menu, or "NO DECK" is displayed, click the menu and select Check Decks one or more times, until HyperDeck Studio is listed without italics, to reestablish deck control.

Avid Media Composer Presets

In order to make it easy to use HyperDeck Studio with Avid Media Composer 6, we recommend you install the Blackmagic HyperDeck Utility software after installing Avid Media Composer 6. This software will install deck presets for HyperDeck Studio which you can select in the Deck Settings window when configuring RS-422 deck control for your project.

19 Using HyperDeck



Genlock

The REF IN port accepts bi-level and tri-level sync signals from a sync generator so you can lock your video equipment to the same signal. Not everyone needs to use genlock but it is particularly important when switching between multiple video sources as is common in larger facilities.

If you notice video flicker or tearing on the LCD when recording video, using a sync generator should help. Make sure your sync generator is set to the same video standard as the video you want to record with HyperDeck Studio. In contrast to conventional tape decks, HyperDeck Studio automatically detects the video standard so there is nothing to configure.

If you're using HyperDeck Studio to record from a camera, the sync generator should be set to the same video standard as the camera.

How to Jog and Shuttle

If you're reviewing a long clip and need to quickly shuttle to a particular section, press the reverse or fast forward button to play through the clip at 2x speed. To go faster, press the reverse or fast forward button again and the speed will increase to 4x and then 8x. Once you've found the section you want to review, press play to resume normal playback.

You can also use the Jog/Shuttle Wheel to shuttle to a particular section at variable speeds. The more you turn it forwards or backwards, the faster HyperDeck Studio will play through your video. Once you've found the section you want to review, press play to resume normal playback.

If you want to slowly jog through your video, frame by frame, press the JOG button once to enable jog operation. Turning the jog/shuttle wheel in the desired direction will then jog through your video. Pressing the JOG button again will return the wheel to shuttle operation.

20 Installing the HyperDeck Shuttle Mounting Plate

The contents of the box includes:

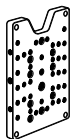

x1
HyperDeck Shuttle
Mounting Plate



x4
Socket Head Screws
M3 x 10mm

You will need:



x1
Hex Allen Key 2.5mm
(not included)

How to Install the HyperDeck Shuttle Mounting Plate

HyperDeck Shuttle Mounting Plate is an optional accessory which lets you secure your HyperDeck Shuttle to a camera rig with your choice of rail mounts, cold shoe mounts, articulated arms and more. You can also use the plate to power your HyperDeck Shuttle from an external battery by attaching a V-Mount or Anton Bauer style battery plate. HyperDeck Shuttle Mounting Plate is available for purchase from Blackmagic Design resellers. For easy installation, please follow these simple steps.

- Step 1.** Peel back the rubber mat from all four corners of the base so you can just see the screws. Remove all four screws.
- Step 2.** Remove the base.
- Step 3.** Attach your HyperDeck Shuttle Mounting Plate using the supplied socket head screws.

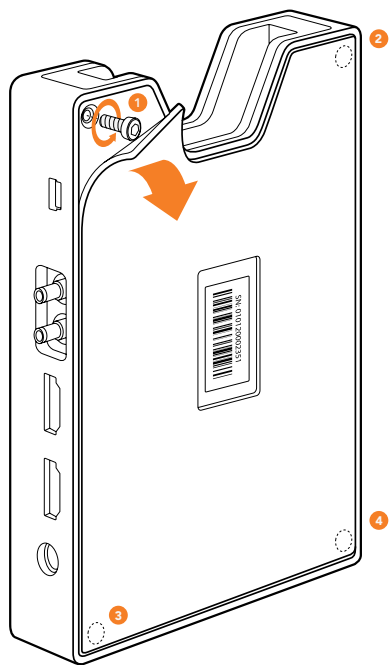

Step 1

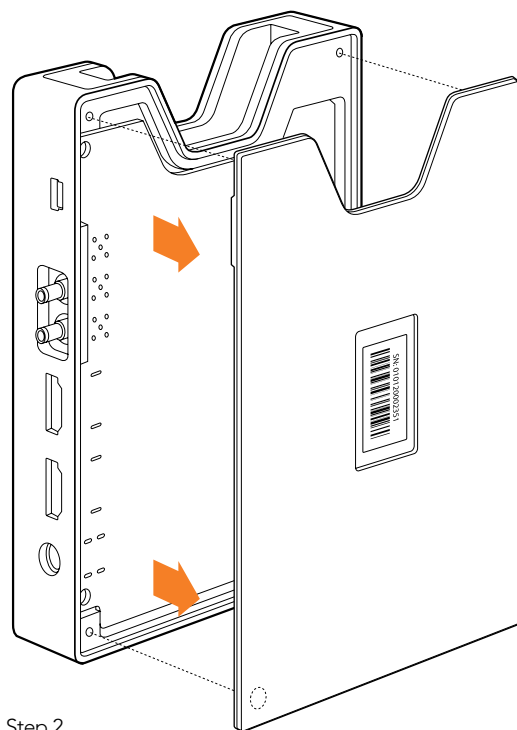

Step 2

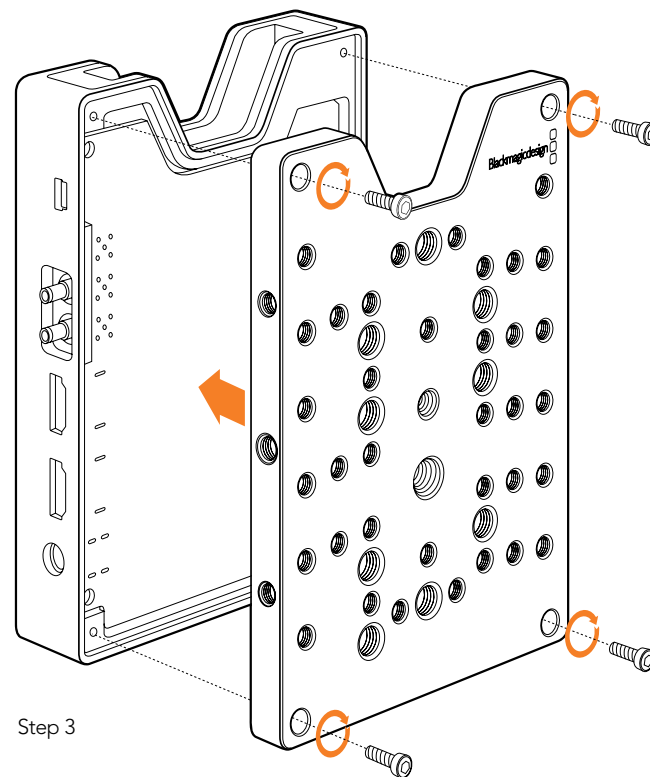

Step 3

The screenshot shows the Blackmagic Design Support Center page for the ATEM 1 M/E Broadcast Panel for Mac OS X. The page layout includes a top navigation bar with links for Products, Resellers, Support, Company, Events, Press, Community, and Post. The main content area is titled 'Support Center' and features a large orange and white lifebuoy graphic. Below the graphic, there are two columns: 'Downloads' and 'Online Resources'. The 'Downloads' section lists two items: 'ATEM Operation Manual' (08 August 2011, 9.69 MB) and 'Blackmagic ATEM Switchers 2.1 for Macintosh' (Date Added: 24 August 2011, Size: 101.41 MB). The 'Online Resources' section lists 'Support Notes' (N/A). At the bottom of the page, there is a 'Still having trouble?' section with a 'Send request' button and contact information for technical support in the United States.

Getting Help

The fastest way to obtain help is to go to the Blackmagic Design online support pages and check the latest support material available for your HyperDeck.

Blackmagic Design Online Support Pages

The latest manual, software and support notes can be found at the Blackmagic Support Center at www.blackmagic-design.com/support.

Contacting Blackmagic Design Support

If you can't find the help you need in our support material, please use the "Send request" button, on the support page for your HyperDeck model, to email a support request. Alternatively call your nearest Blackmagic Design support office at www.blackmagic-design.com/company.

Checking the Version Currently Installed

To check which version of HyperDeck Utility software is installed on your computer, open the About Blackmagic HyperDeck Utility window.

- On Mac OS X, open Blackmagic HyperDeck Utility from the Applications folder. Select About Blackmagic HyperDeck Utility from the application menu to reveal the version number.
- On Windows 7, open Blackmagic HyperDeck Utility from your Start menu. Click on the Help menu and select About Blackmagic HyperDeck Utility to reveal the version number.

How to Get the Latest Updates

After checking the version of HyperDeck Utility software installed on your computer, please visit the Blackmagic Support Center at www.blackmagic-design.com/support to check for the latest updates. While it is usually a good idea to run the latest updates, it is a wise practice to avoid updating any software if you are in the middle of an important project.

22 Developer Information

Supported RS-422 Commands for HyperDeck Studio

		Command	Reply	No Remote	Notes
0 - System Control					
0x00	0x0C	Disable	Acknowledge	-	Always Ignored
0x00	0x11	DeviceTypeRequest	NTSC: 0xF0E0 PAL: 0xF1E0 24P: 0xF2E0	Enabled	
0x00	0x1D	Enable	Acknowledge	-	Always Ignored
1 - Slave Response					
0x20	0x00	Stop	Acknowledge	Disabled	
0x20	0x01	Play	Acknowledge	Disabled	
0x20	0x02	Record	Acknowledge	Disabled	
0x20	0x04	StandbyOff	Acknowledge	-	Always Ignored
0x20	0x05	StandbyOn	Acknowledge	-	Always Ignored
0x20	0x0F	Eject	Acknowledge	-	Always Ignored
0x20	0x10	FastFwd	Acknowledge	Disabled	
0x21	0x11	JogFwd1	Acknowledge	Disabled	
0x22	0x11	JogFwd2	Acknowledge	Disabled	Treated as N=1; Same as JogFwd1
0x21	0x12	VarFwd1	Acknowledge	Disabled	Uses ShuttleFwd1
0x22	0x12	VarFwd2	Acknowledge	Disabled	Treated as N=1; Same as VarFwd1
0x21	0x13	ShuttleFwd1	Acknowledge	Disabled	
0x22	0x13	ShuttleFwd2	Acknowledge	Disabled	Treated as N=1; Same as ShuttleFwd1
0x20	0x20	Rewind	Acknowledge	Disabled	
0x21	0x21	JogRev1	Acknowledge	Disabled	
0x22	0x21	JogRev2	Acknowledge	Disabled	Treated as N=1; Same as JogRev1
0x21	0x22	VarRev1	Acknowledge	Disabled	Uses ShuttleRev1
0x22	0x22	VarRev2	Acknowledge	Disabled	Treated as N=1; Same as VarRev1

23 Developer Information

Supported RS-422 Commands for HyperDeck Studio

		Command	Reply	No Remote	Notes
0x21	0x23	ShuttleRev1	Acknowledge	Disabled	
0x22	0x23	ShuttleRev2	Acknowledge	Disabled	Treated as N=1; Same as ShuttleRev1
0x20	0x30	Preroll	Acknowledge	Disabled	
0x24	0x31	CueData	Acknowledge	Disabled	
0x20	0x34	SyncPlay	Acknowledge	Disabled	
0x21	0x38	ProgSpeedPlayPlus	Acknowledge	Disabled	
0x21	0x39	ProgSpeedPlayMinus	Acknowledge	Disabled	
0x20	0x40	Preview	Acknowledge	Disabled	Status bits are set
0x20	0x41	Review	Acknowledge	Disabled	Status bits are set
0x20	0x43	OutpointPreview	Acknowledge	Disabled	
0x20	0x54	AntiClogTimerDisable	Acknowledge	Disabled	Always Ignored
0x20	0x55	AntiClogTimerEnable	Acknowledge	Disabled	Always Ignored
0x22	0x5C	DMCSetFwd	Acknowledge	Disabled	
0x22	0x5D	DMCSetRev	Acknowledge	Disabled	
0x20	0x60	FullEEOff	Acknowledge	Disabled	
0x20	0x61	FullEEOn	Acknowledge	Disabled	
0x20	0x63	SelectEEOn	Acknowledge	Disabled	
0x20	0x64	EditOff	Acknowledge	Disabled	Always Ignored
0x20	0x65	EditOn	Acknowledge	Disabled	Always Ignored
0x20	0x6A	FreezeOff	Acknowledge	Disabled	Always Ignored
0x20	0x6B	FreezeOn	Acknowledge	Disabled	Always Ignored
4 - Preset/Select Control					
0x44	0x00	Timer1Preset	Acknowledge	Disabled	Always Ignored
0x44	0x04	TimeCodePreset	Acknowledge	Disabled	Always Ignored
0x44	0x05	UserBitPreset	Acknowledge	Disabled	Always Ignored
0x40	0x08	Timer1Reset	Acknowledge	Disabled	Always Ignored
0x40	0x10	InEntry	Acknowledge	Disabled	

24 Developer Information

Supported RS-422 Commands for HyperDeck Studio

		Command	Reply	No Remote	Notes
0x22	0x23	ShuttleRev2	Acknowledge	Disabled	Treated as N=1; Same as ShuttleRev1
0x20	0x30	Preroll	Acknowledge	Disabled	
0x24	0x31	CueData	Acknowledge	Disabled	
0x20	0x34	SyncPlay	Acknowledge	Disabled	
0x21	0x38	ProgSpeedPlayPlus	Acknowledge	Disabled	
0x21	0x39	ProgSpeedPlayMinus	Acknowledge	Disabled	
0x40	0x11	OutEntry	Acknowledge	Disabled	
0x40	0x12	AudiInEntry	Acknowledge	Disabled	Always Ignored
0x40	0x13	AudioOutEntry	Acknowledge	Disabled	Always Ignored
0x44	0x14	InDataPreset	Acknowledge	Disabled	
0x44	0x15	OutDataPreset	Acknowledge	Disabled	
0x44	0x16	AudiInDataPreset	Acknowledge	Disabled	Always Ignored
0x44	0x17	AudioOutDataPreset	Acknowledge	Disabled	Always Ignored
0x40	0x18	InFwd	Acknowledge	Disabled	
0x40	0x19	InRev	Acknowledge	Disabled	
0x40	0x1A	OutFwd	Acknowledge	Disabled	
0x40	0x1B	OutRev	Acknowledge	Disabled	
0x40	0x1C	AudiInFwd	Acknowledge	Disabled	Always Ignored
0x40	0x1D	AudiInRev	Acknowledge	Disabled	Always Ignored
0x40	0x1E	AudioOutFwd	Acknowledge	Disabled	Always Ignored
0x40	0x1F	AudioOutRev	Acknowledge	Disabled	Always Ignored
0x40	0x20	InReset	Acknowledge	Disabled	
0x40	0x21	OutReset	Acknowledge	Disabled	
0x40	0x22	AlnReset	Acknowledge	Disabled	
0x40	0x23	AOutReset	Acknowledge	Disabled	
0x40	0x24	InRecall	Acknowledge	Disabled	Always Ignored
0x40	0x25	OutRecall	Acknowledge	Disabled	Always Ignored
0x40	0x26	AudiInRecall	Acknowledge	Disabled	Always Ignored

25 Developer Information

Supported RS-422 Commands for HyperDeck Studio

		Command	Reply	No Remote	Notes
0x40	0x27	AudioOutRecall	Acknowledge	Disabled	Always Ignored
0x40	0x2D	LostLockReset	Acknowledge	Disabled	Always Ignored
0x42	0x30	EditPreset	Acknowledge	Disabled	Always Ignored
0x44	0x31	PrerollPreset	Acknowledge	Disabled	
0x41	0x32	TapeAutoSelect	Acknowledge	Disabled	Always Ignored
0x41	0x33	ServoRefSelect	Acknowledge	Disabled	Always Ignored
0x41	0x34	HeadSelect	Acknowledge	Disabled	Always Ignored
0x41	0x35	ColorFrameSelect	Acknowledge	Disabled	Always Ignored
0x41	0x36	TimerModeSelect	Acknowledge	Disabled	Always Ignored
0x41	0x37	InputCheck	Acknowledge	Disabled	Always Ignored
0x41	0x3A	EditFieldSelect	Acknowledge	Disabled	Always Ignored
0x41	0x3B	FreezeModeSelect	Acknowledge	Disabled	Always Ignored
0x40	0x40	AutoModeOff	Acknowledge	Disabled	ignored, Status bit remembered
0x40	0x41	AutoModeOn	Acknowledge	Disabled	ignored, Status bit remembered
0x40	0x42	SpotEraseOff	Acknowledge	Disabled	Always Ignored
0x40	0x43	SpotEraseOn	Acknowledge	Disabled	Always Ignored
0x40	0x45	AudioSplitOn	Acknowledge	Disabled	Always Ignored
0x42	0xF8	StillOffTime	Acknowledge	Disabled	Always Ignored
0x42	0xFA	StdbbyOffTime	Acknowledge	Disabled	Always Ignored
6 - Sense Request					
0x61	0x0A	TimeCodeGenSense			
		Request for Gen TC	GenTCData	Enabled	
		Request for Gen UB	GenUBData	Enabled	Always Ignored
		Request for Gen TC/UB	GenTCUBData	Enabled	Always Ignored
0x61	0x0C	CurrentTimeSense			Always Ignored
		CorrectedLTCTimeSense	CorrectedLTCTimeData	Enabled	Always Ignored

26 Developer Information

Supported RS-422 Commands for HyperDeck Studio

		Command	Reply	No Remote	Notes
		VITCTimeSense	VITCTimeData	Enabled	Always Ignored
		SpecialTimSense	CorrectedLTCTimeData	Enabled	Always Ignored
		Timer1Sense	Timer1Data	Enabled	
		UserBitsVITCTimeSense	UserBitsVITCTimeData	Enabled	
		LTCUserBitsTimeSense	LTCUserBitsTimeData	Enabled	
		VITCUserBitsTimeSense	VITCUserBitsTimeData	Enabled	
0x60	0x10	InDataSense	InData	Enabled	
0x60	0x11	OutDataSense	OutData	Enabled	
0x60	0x12	AlnDataSense	AlnData	Enabled	
0x60	0x13	AOutDataSense	AOutData	Enabled	
0x61	0x20	StatusSense	StatusData	Enabled	
0x60	0x2E	SpeedSense	SpeedData	Enabled	
0x60	0x31	PrerollTimeSense	PreRollTimeData	Enabled	
0x60	0x36	TimerModeSense	TimerModeData	Enabled	
0x60	0x3E	RecordInhibitSense	RecordInhibitStatus	Enabled	
7 - Sense Reply					
0x78	0x00	Timer1Data	-	-	Current Time and 00:00:00:00
0x78	0x04	LTCUserBitsTimeData	-	-	Current Time and 00:00:00:00
0x78	0x06	VITCUserBitsTimeData	-	-	Current Time and 00:00:00:00
0x74	0x06	VITCTimeData	-	-	Current Time
0x74	0x07	UserBitsVITCTimeData	-	-	00:00:00:00
0x74	0x08	GenTCData	-	-	Current Time
0x78	0x08	GenTCUBData	-	-	Current Time and 00:00:00:00
0x74	0x09	GenUBData	-	-	00:00:00:00
0x74	0x10	InData	-	-	

27 Developer Information

Supported RS-422 Commands for HyperDeck Studio

		Command	Reply	No Remote	Notes
0x74	0x11	OutData	-	-	
0x74	0x12	AlnData	-	-	
0x74	0x13	AOutData	-	-	
0x74	0x14	CorrectedLTCTimeData	-	-	Current Time
0x70	0x20	StatusData	-	-	Please see "Status Bits" sheet: Limited to 9 bytes of status, silently truncated
0x71	0x2E	SpeedData	-	-	
0x74	0x31	PrerollTimeData	-	-	
0x71	0x36	TimerModeData	-	-	Returns 0 (TimeCode)
0x72	0x3E	RecordInhibitStatus	-	-	

28 Developer Information

RS-422 Status Bytes for HyperDeck Studio

	Bit 7	Bit 6	Bit 5	Bit 4	Bit 3	Bit 2	Bit 1	Bit 0
Byte 0	0	0	Cassette out	0	0	0	0	Local
Byte 1	Standby	0	Stop	Play	Rewind	Forward	0	0
Byte 2	Servo Lock	0	Shuttle	Jog	Var	Direction	Still	1
Byte 3	Auto Mode	0	0	0	Aout Set	Ain Set	Out Set	In Set
Byte 4	Select EE	Full EE	0	0	0	0	0	0
Byte 5	0	0	0	0	0	0	0	0
Byte 6	0	Lamp Still	Lamp Fwd	Lamp Rev	0	0	0	0
Byte 7	0	0	0	0	0	0	0	0
Byte 8	0	0	Near EOT	EOT	0	0	0	0
Byte 9	0	0	0	0	0	0	0	0

Variables	
Cassette Out	Set if no SSD is present
Local	Set if Remote is disabled (local control)
Standby	Set if a disk is available
Direction	Clear if playback is forwarding, set if playback is reversing
Still	Set if playback is paused, or if in input preview mode
Auto Mode	Set if in Auto Mode
Select EE, Full EE	Set if in input preview mode
Lamp Still/Fwd/Rev	Set according to playback speed and direction
Near EOT	Set if total space left on available SSD's is less than 3 minutes
EOT	Set if total space left on available SSD's is less than 30 seconds

Others	
Cue Complete (byte 2, bit 0)	Always 1: Cue requests are always instantaneous

HyperDeck Serial RS-422 Protocol		
Protocol	Based on Sony 9-pin protocol	
Interface	Baud rate	38.4 kBits/s
	1 start bit	
	8 data bits	
	1 stop bit	
	1 parity bit	
	Odd parity	

12 Month Limited Warranty

Blackmagic Design warrants that this product will be free from defects in materials and workmanship for a period of 12 months from the date of purchase. If a product proves to be defective during this warranty period, Blackmagic Design, at its option, either will repair the defective product without charge for parts and labor, or will provide a replacement in exchange for the defective product.

In order to obtain service under this warranty, you the Customer, must notify Blackmagic Design of the defect before the expiration of the warranty period and make suitable arrangements for the performance of service. The Customer shall be responsible for packaging and shipping the defective product to a designated service center nominated by Blackmagic Design, with shipping charges pre paid. Customer shall be responsible for paying all shipping charges, insurance, duties, taxes, and any other charges for products returned to us for any reason.

This warranty shall not apply to any defect, failure or damage caused by improper use or improper or inadequate maintenance and care. Blackmagic Design shall not be obligated to furnish service under this warranty: a) to repair damage resulting from attempts by personnel other than Blackmagic Design representatives to install, repair or service the product, b) to repair damage resulting from improper use or connection to incompatible equipment, c) to repair any damage or malfunction caused by the use of non Blackmagic Design parts or supplies, or d) to service a product that has been modified or integrated with other products when the effect of such a modification or integration increases the time or difficulty of servicing the product. THIS WARRANTY IS GIVEN BY BLACKMAGIC DESIGN IN LIEU OF ANY OTHER WARRANTIES, EXPRESS OR IMPLIED. BLACKMAGIC DESIGN AND ITS VENDORS DISCLAIM ANY IMPLIED WARRANTIES OF MERCHANTABILITY OR FITNESS FOR A PARTICULAR PURPOSE. BLACKMAGIC DESIGN'S RESPONSIBILITY TO REPAIR OR REPLACE DEFECTIVE PRODUCTS IS THE WHOLE AND EXCLUSIVE REMEDY PROVIDED TO THE CUSTOMER FOR ANY INDIRECT, SPECIAL, INCIDENTAL OR CONSEQUENTIAL DAMAGES IRRESPECTIVE OF WHETHER BLACKMAGIC DESIGN OR THE VENDOR HAS ADVANCE NOTICE OF THE POSSIBILITY OF SUCH DAMAGES. BLACKMAGIC DESIGN IS NOT LIABLE FOR ANY ILLEGAL USE OF EQUIPMENT BY CUSTOMER. BLACKMAGIC IS NOT LIABLE FOR ANY DAMAGES RESULTING FROM USE OF THIS PRODUCT. USER OPERATES THIS PRODUCT AT OWN RISK.

© Copyright 2012 Blackmagic Design. All rights reserved. 'Blackmagic Design', 'DeckLink', 'HDLink', 'Workgroup Videohub', 'Multibrige Pro', 'Multibrige Extreme', 'Intensity' and 'Leading the creative video revolution' are registered trademarks in the US and other countries. All other company and product names may be trade marks of their respective companies with which they are associated.