

Installation and Operation Manual

HyperDeck Shuttle HyperDeck Studio

Blackmagicdesign 



Mac OS X™
Windows™
November 2012

Welcome



Welcome to HyperDeck!

Welcome to HyperDeck!

We hope you share our dream for the television industry to become a truly creative industry by allowing anyone to have access to the highest quality video.

Our range of HyperDeck disk recorders have made it easier and more affordable than ever to record and play back full 10-bit uncompressed video. HyperDeck records directly to removable 2.5" Solid State Disks (SSDs) that are getting bigger, faster and more affordable every day. It's incredible that you can now record the most amazing quality SD and HD video onto something so small, and record and play an SSD thousands of times without any degradation in quality!

You can bypass unwanted camera compression and record directly from HDMI or SDI cameras straight to SSD and even connect to any HDMI or SDI monitor for instant playback! SSDs can also be mounted on any computer for immediate editing and fast transfer of your media. With no moving parts, SSDs are unbelievably robust and can handle harsh conditions that would destroy conventional hard drives and videotapes!

If you need longer recording times for each SSD, then HyperDeck also records and plays back Apple ProRes and Avid DNxHD files. These 10-bit quality codecs retain fantastic picture quality and increase the recording length of SSDs by more than 5 times!

This instruction manual contains all the information you need to start using your HyperDeck disk recorder. For uncompressed recording you need to use an SSD that supports the required data speed and we are continually adding details on our website of new SSDs that we have tested.

Please check the support page on our web site at www.blackmagicdesign.com for the latest version of this manual and updates to the HyperDeck software. Keeping your software up to date will always ensure you get all the latest features. When downloading software, please register with your information so we can keep you updated when new software is released. We are constantly working on new features and improvements, so we would love to hear from you!

A handwritten signature in black ink that reads "Grant Petty". The signature is written in a cursive, flowing style.

Grant Petty
CEO Blackmagic Design

4 Getting Started

Introducing HyperDeck	4
About SSDs	5
Choosing the Right SSD	5
Preparing SSDs for HyperDeck	6
Selecting Your Video Format	8
Recording and Playing Clips	9
Recording Video with HyperDeck Shuttle	9
Recording Video with HyperDeck Studio	9
Playing Video	10
Accessing Media on Mac OS X	10
Accessing Media on Windows	10
Externally Controlling Your HyperDeck	11
SDI Start/Stop Recording	11
Timecode Run Recording	11
RS-422 Deck Control	11

12 Updating the HyperDeck Software

HyperDeck Utility	12
How to Update Your HyperDeck Software on Mac OS X	12
How to Update Your HyperDeck Software on Windows	12

13 Using HyperDeck

Using HyperDeck	13
Disk Check	13
Recording	13
Playback	16
RS-422 Control	18

24 Using HyperDeck Shuttle

HyperDeck Shuttle Controls	24
HyperDeck Shuttle Connections	25
Installing the HyperDeck Shuttle Mounting Plate	26

27 Using HyperDeck Studio

HyperDeck Studio Controls	27
HyperDeck Studio Connections	28

29 Help

Getting Help	29
Blackmagic Design Online Support Pages	29
Contacting Blackmagic Design Support	29
Checking the Version Currently Installed	29
How to Get the Latest Updates	29

30 Warranty Information

4 Getting Started



HyperDeck Shuttle



HyperDeck Studio

Introducing HyperDeck

HyperDeck disk recorders record uncompressed SD and HD video quality directly to low cost solid state disks. Video playback can be viewed on an SDI or HDMI monitor or you can connect the SSD to a computer and edit directly from the SSD media itself. HyperDeck disk recorders have internal 3 Gb/s SATA ports which are used with standard 2.5" SSDs.

HyperDeck disk recorders have SDI and HDMI connectors making it easy to work with a huge range of professional and consumer video equipment. SDI and HDMI connectors also support embedded audio.

HyperDeck Shuttle is compact, affordable and battery powered, so it's perfect as a field recorder. HyperDeck Shuttle bypasses your camera's compression and records from SDI and HDMI directly into the highest quality uncompressed video. The latest model can even record and play back in the Apple ProRes and Avid DNxHD formats if compressed video better suits your workflow or if you need to fit more video on an SSD.

HyperDeck Shuttle Mounting Plate can be purchased if you want to secure your HyperDeck Shuttle to a camera rig with your choice of rail mounts, cold shoe mounts, articulated arms and more. You can also use the plate to power your HyperDeck Shuttle from an external battery by attaching a V-Mount or Anton Bauer style battery plate.

HyperDeck Studio is a rack mount broadcast deck style recorder that features dual SSD slots so it can automatically continue recording onto the next SSD when one disk is full. HyperDeck Studio features uncompressed video quality recording and playback, RS-422 deck control, genlock, jog and shuttle, an integrated LCD, and is affordable and easy to use. It can even record and play back in the Apple ProRes and Avid DNxHD formats if compressed video better suits your workflow or if you need to fit more video on an SSD. HyperDeck Studio is the broadcast deck for the 21st century!

HyperDeck Studio is rack-mountable and is only 1 RU high and less than 4 inches deep. It's the perfect size when space is tight such as in broadcast vans and fly away rack cases.

5 Getting Started



About SSDs

Choosing the Right SSD

When working with uncompressed video it's important to carefully check the SSD you would like to use. This is because some SSDs can have up to 50% lower write speed than the manufacturer's claimed speed, so even though the disk specifications claim an SSD is fast enough to handle video, in reality the disk is not fast enough for real time video data recording. Hidden data compression mostly affects recording and often these disks can still be used for real time playback.

In our testing, we have found larger newer models of SSD, and larger capacity SSDs are generally faster. SSDs recommended for use with HyperDeck and uncompressed 10-bit HD video recording include:

- Crucial 256GB C300
- Crucial 512GB M4 (firmware 009)
- Kingston 64GB SSDNow V+100
- Kingston 128GB SSDNow V+100
- Kingston 240GB SSDNow V+200
- Kingston HyperX 240GB
- OCZ 240GB Vertex 3
- OCZ 480GB Vertex 3
- Sandisk Extreme 480GB.

Please check the tech notes on the Blackmagic Design web site for the latest information.

If you find an SSD which isn't fast enough for uncompressed HD video, try a faster SSD or use HyperDeck Utility to switch to a compressed recording format such as ProRes or DNxHD. These recording formats have a much lower data rate and are easier for the SSD to handle.



6 Getting Started

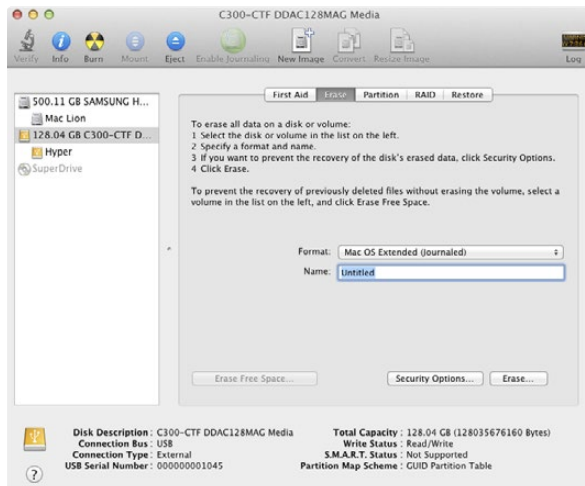

Use Disk Utility on Mac OS X to erase your SSD in the Mac OS Extended (Journaled) or ExFAT format.

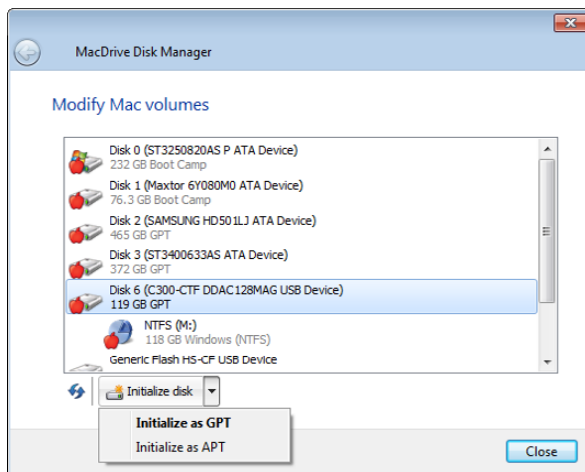

Use MacDrive software on Windows to initialize the SSD with a GPT and create an HFS+ volume.

Preparing SSDs for HyperDeck

SSDs used by HyperDeck must be formatted as either HFS+ or ExFAT. These disk formats allow long clips to be recorded in a single file per clip. Simply connect the SSD to your computer with an external dock or cable adapter and format it as you would a regular disk. Make sure you back up anything important from your SSD as you will lose everything on it when you format it.

HFS+ is also known as Mac OS Extended. It is the recommended format for HyperDeck as it supports "journaling". In the event of a hardware or software malfunction, data on a journaled SSD is more quickly recovered and less likely to be corrupted in the first place. HFS+ is natively supported by Mac OS X. Windows computers can use HFS+ with the purchase and installation of MediaFour MacDrive software from <http://www.mediafour.com>.

ExFAT is supported natively by Mac OS X and Windows without needing to purchase any additional software. However ExFAT does not support journaling which means data is more prone to corruption, and less likely to be recovered, in the event of a hardware or software malfunction.

Preparing SSDs on a Mac OS X computer

The Disk Utility application included with Mac OS X can format a drive in the HFS+ or ExFAT formats.

- Step 1.** Connect the SSD to your computer and dismiss any message offering to use your SSD for Time Machine backups.
- Step 2.** Go to /Applications/Utilities and launch Disk Utility.
- Step 3.** Click on the disk icon of your SSD and then click the Erase tab.
- Step 4.** Set the Format to "Mac OS Extended (Journaled)" or "ExFAT", type a Name for the new volume and then click Erase. Your SSD will quickly be formatted and made ready for use with HyperDeck.

Preparing SSDs on a Windows computer

MacDrive software can format a drive in the HFS+ format on a Windows PC.

- Step 1.** Install MediaFour MacDrive and restart your PC.
- Step 2.** Connect the SSD to your computer.
- Step 3.** Choose Start>Computer and right-click on your SSD.
- Step 4.** From the contextual menu, choose MacDrive>Format Mac Disk.
- Step 5.** Select the SSD in the MacDrive Disk Manager and choose Initialize disk>Initialize as GPT.
- Step 6.** Choose "Automatically create an HFS+ volume" and click "Initialize Disk".
- Step 7.** Once the format has been completed, your SSD is ready for use with HyperDeck.

7 Getting Started

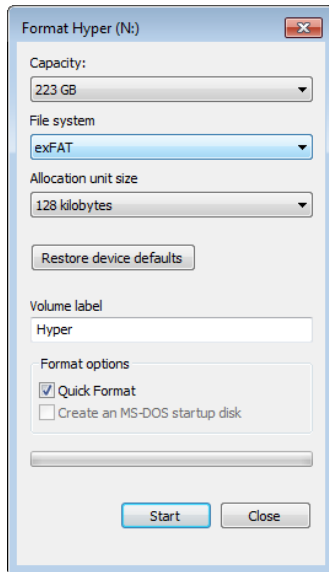

Use the Format dialog box feature in Windows to format your SSD in the ExFAT format.

The Format dialog box can format a drive in the ExFAT format on a Windows PC.

- Step 1.** Connect the SSD to your computer.
- Step 2.** Choose Start>Computer and right-click on your SSD.
- Step 3.** From the contextual menu, choose Format.
- Step 4.** Set the file system to "exFAT" and the allocation unit size to 128 kilobytes.
- Step 5.** Type a volume label, select "Quick Format" and click "Start".
- Step 6.** Your SSD will quickly be formatted and made ready for use with HyperDeck.

8 Getting Started

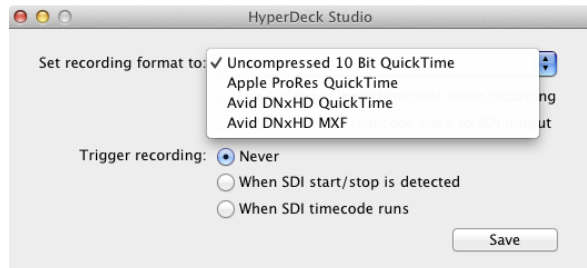

Selecting Your Video Format

HyperDeck Studio and HyperDeck Shuttle 2 let you select from a choice of uncompressed and compressed video formats. The original HyperDeck Shuttle exclusively records in an uncompressed video format.

HyperDeck can play back 10 bit uncompressed QuickTime files on a fast SSD, or to a compressed format if you have a slower SSD or want to fit longer high definition recordings on a single SSD. This means it is possible to have uncompressed QuickTime files as well as compressed files on the same disk if you have used the HyperDeck Utility software to change the recording format.

Working with uncompressed video is exciting as there is no better quality than uncompressed. However if compressed video better suits your workflow, or if you need to fit more video on an SSD, you can choose a high quality professional compressed video format which is also perfect for editing. The following table shows the video formats supported by your HyperDeck model.

	HyperDeck Shuttle	HyperDeck Shuttle 2	HyperDeck Studio
Uncompressed 10-bit QuickTime	•	•	•
Apple ProRes 422 (HQ) QuickTime		•	•
Avid DNxHD 220 Mb/s QuickTime		•	•
Avid DNxHD 220 Mb/s MXF		•	•

To choose a compressed video format:

- Step 1.** Connect HyperDeck to your computer via USB.
- Step 2.** Launch HyperDeck Utility. The title bar of the utility will show you if you have an HyperDeck Shuttle, HyperDeck Shuttle 2 or HyperDeck Studio.
- Step 3.** Set the recording format to the desired codec from the pulldown menu and save the setting. You can now disconnect the USB cable if you wish.

All subsequent clips will be recorded in the compressed format. If you want to switch back to uncompressed video, repeat the procedure and choose "Uncompressed 10 Bit" from the pulldown menu.

Setting the recording format also sets the playback format so you will only be able to play back clips that match the current recording format. Any other clips will be hidden which helps prevent slow SSDs from being accidentally used to play back high data rate uncompressed clips which they might not be fast enough to play.

Recording and Playing Clips

HyperDeck ships ready to record and play back with uncompressed SD and HD video quality. You can start recording immediately without having to configure any settings and all you need is a recommended SSD formatted in the HFS+ or ExFAT format.

The "Using HyperDeck" section later in this manual provides information about changing settings for recording and playback as well as more detailed steps for recording, playback and using RS-422 control.

If HyperDeck records from a video source that contains closed caption data, your HyperDeck will record the QuickTime or MXF movie as well as a separate .MCC file containing the closed caption data. The .MCC file will have the same name as your recorded movie but with a .MCC extension.

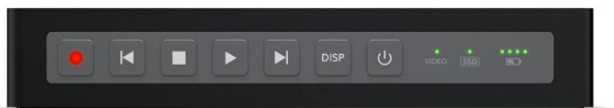

HyperDeck Shuttle recording video.



HyperDeck Studio recording video.

Recording Video with HyperDeck Shuttle

- Step 1.** Insert a recommended SSD which has been formatted in the HFS+ or ExFAT format.
- Step 2.** Connect your video source to the SDI or HDMI input and the Video status LED should light up.
- Step 3.** Press the Record button and the SSD light will flash to indicate SSD activity.
- Step 4.** Press the Stop button to finish your recording.

Recording Video with HyperDeck Studio

- Step 1.** Insert a recommended SSD, formatted in the HFS+ or ExFAT format, into either SSD slot.
- Step 2.** Connect your video source to an HyperDeck Studio input. Press the INPUT button once, while the stop button is illuminated, to preview the video source on the LCD before recording. If you don't see the video you want, press the button again to switch between the HDMI and SDI inputs.
- Step 3.** Press the record button to start recording to the SSD instantly. The SSD slot light will illuminate with a looping red light to indicate it is being used for recording.
- Step 4.** Press the Stop button to finish your recording.

If the record button flashes, this means the disk is not fast enough and recording cannot keep up. We recommend you change to a compressed recording format such as ProRes or DNxHD, or use a faster recommended SSD for uncompressed recording.

10 Getting Started

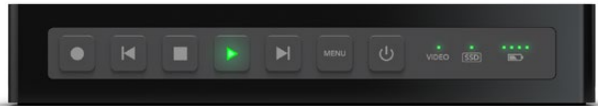

HyperDeck Shuttle playing back video.



HyperDeck Studio playing back video.

Playing Video

Playing back a clip is simple and instantaneous.

If you're recording with HyperDeck Shuttle, press the Stop button once to stop recording. Press it again to switch to playback. Then simply press Play and you'll see your video on any displays connected to the SDI and HDMI outputs.

If you're recording with HyperDeck Studio, press the play button once for instant playback and you'll see your video on any displays connected to the SDI and HDMI outputs.

The controls of your HyperDeck work just like a CD player so pressing next clip will skip to the start of the next clip and continue playing. Press previous clip once to go to the start of the current clip or press twice to skip back to the start of the previous clip.

If the play button flashes, this means the disk is not fast enough and playback cannot keep up. We recommend you change to a compressed recording format such as ProRes or DNxHD, or use a faster recommended SSD for uncompressed recording.

If you play back a video clip which has an associated .MCC file, the closed caption data will be played out with the video via the SDI output of your HyperDeck.

Accessing Media on Mac OS X

Compressed and uncompressed QuickTime™ movies recorded by HyperDeck can be opened in almost any video software on Mac OS X.

DNxHD MXF files recorded by HyperDeck can be opened with Avid Media Composer and DaVinci Resolve for Mac.

MCC closed caption data files recorded by HyperDeck can be opened with MaCCaption software for Mac OS X from <http://www.cpcweb.com>.

Accessing Media on Windows

Compressed and uncompressed QuickTime™ movies recorded by HyperDeck require QuickTime be installed on your PC. Almost any video software on Windows that supports QuickTime can open movies recorded by HyperDeck. QuickTime for Windows can be downloaded free from Apple's website at <http://www.apple.com/quicktime/download/>.

DNxHD MXF files recorded by HyperDeck can be opened with Avid Media Composer and DaVinci Resolve for Windows.

MCC closed caption data files recorded by HyperDeck can be opened with CaptionMaker software for Windows from <http://www.cpcweb.com>.

11 Getting Started

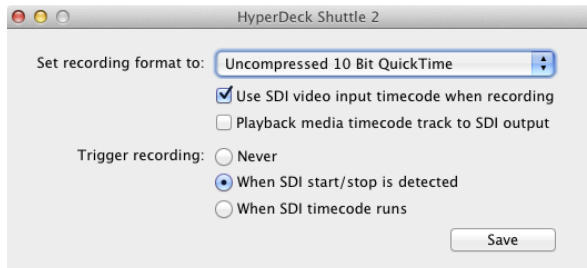

Externally Controlling Your HyperDeck

There are several ways you can remotely control your HyperDeck and more detailed instructions are provided in the "Using HyperDeck" section of this manual.

SDI Start/Stop Recording

Start/stop recording means that when you press the record button on an HD-SDI camera, HyperDeck will start recording without also having to press the record button on your HyperDeck disk recorder. You will need a camera which can trigger the "record" function of HyperDeck via HD-SDI.

Use HyperDeck Utility to set Trigger recording to "When SDI start/stop is detected". On HyperDeck Studio, the REM button needs to be selected to allow trigger recording.

Timecode Run Recording

Timecode run recording is similar to start/stop recording but is only used if your HD-SDI camera does not support trigger recording via HD-SDI.

Change your camera's timecode settings from "free run timecode" to "record run timecode" and use HyperDeck Utility to set Trigger recording to "When SDI timecode runs". On HyperDeck Studio, the REM button must also be pressed and illuminated to allow trigger recording.

Now whenever your HyperDeck detects the timecode running via HD-SDI, it will start recording. It will stop recording whenever the timecode stops.

Be careful if your HyperDeck is connected to the SDI output of a video router, as any change to the video source might cause HyperDeck to start recording unexpectedly due to a change in timecode being detected via HD-SDI.

RS-422 Deck Control

You can remotely control HyperDeck Studio using your favorite NLE software and video capture hardware to remotely capture, batch capture and play back video with your HyperDeck Studio. All you need to do is connect an RS-422 cable between your capture device and HyperDeck Studio and press the REM button to enable remote deck control.

12 Updating the HyperDeck Software



HyperDeck Utility

Blackmagic HyperDeck Utility is used to change settings and update the internal software in your HyperDeck. In addition to installing HyperDeck Utility, uncompressed 10 bit codecs are installed for Mac and Windows. If you use Avid Media Composer 6.x, you'll also find a HyperDeck Studio deck preset is installed to help with RS-422 deck control.

How to Update Your HyperDeck Software on Mac OS X

After downloading the HyperDeck Utility software and unzipping the downloaded file, open the resulting disk image to reveal its contents.

Launch the HyperDeck Installer and follow the onscreen instructions.

After installing the latest Blackmagic HyperDeck Utility on your computer, connect a USB cable between the computer and the HyperDeck. Launch Blackmagic HyperDeck Utility and follow any onscreen prompt to update the internal software in your HyperDeck. If no prompt appears, the internal software is up to date and there is nothing further you need to do. We recommend you also update your HyperDeck to ensure you are able to get any new software.

How to Update Your HyperDeck Software on Windows

After downloading the HyperDeck Utility software and unzipping the downloaded file, you should see a HyperDeck Utility folder containing this PDF manual and the HyperDeck Utility installer.

Double-click the installer and follow the onscreen prompts to complete the installation.

After installing the latest Blackmagic HyperDeck Utility on your computer, connect a USB cable between the computer and the HyperDeck. Launch Blackmagic HyperDeck Utility and follow any onscreen prompt to update the internal software in your HyperDeck. If no prompt appears, the internal software is up to date and there is nothing further you need to do. We recommend you also update your HyperDeck to ensure you get the latest software features.

13 Using HyperDeck



Using HyperDeck

Disk Check

When you first switch on HyperDeck, or any time you insert an SSD, the SSD indicator will light up while checking the SSD and then switch off. If the SSD has not been formatted correctly, or fails to work, the SSD indicator will illuminate solid red until the SSD is removed. Refer to the previous section "Preparing SSDs for HyperDeck" to check if the SSD is formatted correctly and also check that it works with a computer.

Recording

Recording Clips with HyperDeck Shuttle

Before recording, format a recommended SSD in the HFS+ or ExFAT format and use HyperDeck Utility to choose your recording format.

- Step 1.** Insert the formatted SSD into HyperDeck Shuttle. As it reads the disk, the SSD light on the unit will illuminate. When the light goes off, HyperDeck Shuttle is ready to record.
- Step 2.** Connect your video source to the HyperDeck Shuttle's input. It doesn't matter if you use the HDMI or SDI input, as HyperDeck Shuttle will automatically detect which one is connected. You can also connect the video output of the HyperDeck Shuttle to your HDMI or SDI monitor. All outputs are active so you can use either one connection or both SDI and HDMI outputs together.
- Step 3.** If you see the Video status LED light up, it means that HyperDeck Shuttle has detected a valid video input.
- Step 4.** If you don't see your source video on the output, press the Stop button to switch HyperDeck Shuttle between video input loop through and playback.
- Step 5.** Press the Record button and HyperDeck Shuttle will start recording instantly. The SSD light will also flash to indicate the SSD activity. Once you've finished recording, press the Stop button.

If the Stop button starts flashing while recording, there are only 3 minutes of recording time left on the SSD. Make sure you have another empty SSD ready so you don't miss the next take.

14 Using HyperDeck

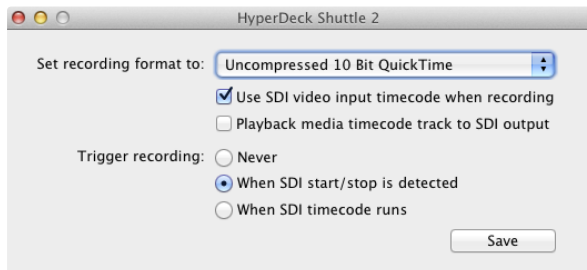
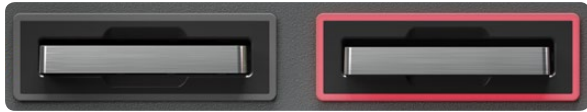

Recording Clips with HyperDeck Studio

Before recording, format a recommended SSD in the HFS+ or ExFAT format and use HyperDeck Utility to choose your recording format.

- Step 1.** Insert a recommended and correctly formatted SSD into either SSD slot.
- Step 2.** Connect your video source to an HyperDeck Studio input. Press the INPUT button once, while the stop button is illuminated, to preview the video source on the LCD before recording. If you don't see the video you want, press the button again to switch between the HDMI and SDI inputs. You can also connect the video outputs of the HyperDeck Studio to your HDMI and SDI monitors. All outputs are active so you can use one or more outputs together.
- Step 3.** Press the record button to start recording to the SSD instantly. The SSD slot light will illuminate with a looping red light to indicate it is being used for recording.
- Step 4.** Press the Stop button when you've finished recording.

Start/Stop Recording

HyperDeck Shuttle and HyperDeck Studio support start/stop recording which means that, when you press the record button on an HD-SDI camera, HyperDeck will start recording without also having to press the record button on your HyperDeck disk recorder.

To set up start/stop recording for supported cameras:

- Step 1.** You will need a camera which can trigger the "record" function of HyperDeck via HD-SDI. Cameras which support trigger recording via HD-SDI may include menu options such as "Trigger REC", "HD-SDI Remote I/F" or "SDI Remote Start/Stop Trigger".
- Step 2.** In HyperDeck Utility, set Trigger recording to "When SDI start/stop is detected". The REM button must also be pressed and illuminated on HyperDeck Studio to allow trigger recording.

15 Using HyperDeck

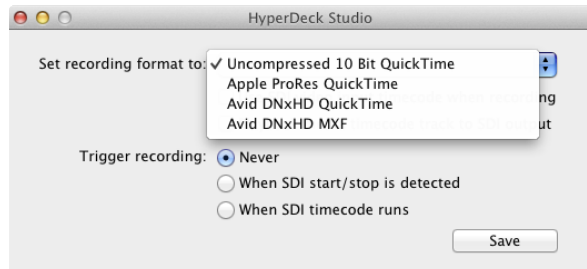

Timecode Run Recording

HyperDeck Shuttle and HyperDeck Studio also support timecode run recording, which is similar to start/stop recording, but is only used if your HD-SDI camera does not support trigger recording via HD-SDI.

To set up timecode run recording:

- Step 1.** Go into your camera's timecode settings and change them from "free run timecode" to "record run timecode".
- Step 2.** In HyperDeck Utility, set Trigger recording to "When SDI timecode runs". The REM button must also be pressed and illuminated on HyperDeck Studio to allow trigger recording.

Now whenever your HyperDeck detects the timecode running via HD-SDI, it will start recording. It will stop recording whenever the timecode stops.

If your HyperDeck is connected to the SDI output of a video router, any change to the video source might cause HyperDeck to start recording unexpectedly due to a change in timecode being detected via HD-SDI.

Recording RP 188 Embedded Timecode

When recording from HD-SDI video sources which provide embedded SMPTE RP 188 metadata, switching on the option to "Use SDI video input timecode when recording" will record the embedded timecode from the video source instead of using timecode generated by your HyperDeck. It might be necessary to turn on the RP 188 setting in your camera before HyperDeck will be able to record the timecode.

16 Using HyperDeck

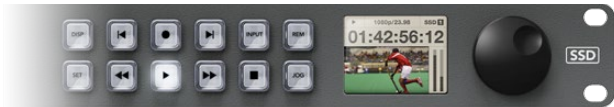

Playback

Playing Back Clips

Playing back a clip is simple and instantaneous.

If you're recording with HyperDeck Shuttle, press the Stop button once to stop recording. Press it again to switch to playback. Then simply press Play.

If you're recording with HyperDeck Studio, press the play button once for instant playback.

The controls of HyperDeck work just like a CD player so pressing next clip will skip to the start of the next clip and continue playing. Press previous clip once to go to the start of the current clip or press twice to skip back to the start of the previous clip.

Accessing Your Clips

HyperDeck can play back movies in the QuickTime and MXF file formats including closed caption data.

QuickTime movies require QuickTime be installed on your computer. QuickTime for Mac is built into Mac OS X™. QuickTime for Windows™ can be downloaded free from Apple's website at:
<http://www.apple.com/quicktime/download/>.

DNxHD MXF files can be used with Avid Media Composer and DaVinci Resolve on Mac OS X and Windows.

MCC closed caption data files recorded by HyperDeck can be opened with CaptionMaker software for Windows from <http://www.cpcweb.com>.

17 Using HyperDeck

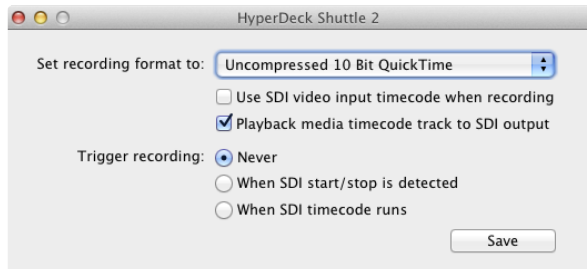

HyperDeck Studio shows embedded SDI timecode on its display.

Playing Back RP 188 Embedded Timecode

If you use HyperDeck Utility to switch on the option to "Play back media timecode track to SDI output" when playing back high definition video, your HyperDeck will embed SMPTE RP 188 metadata allowing other video equipment to display or record the timecode.

Timecode is also commonly displayed on HD-SDI monitors but you will often need to find a menu setting to turn it on. The LCD display in HyperDeck Studio also displays the RP 188 timecode during playback.

Looping Playback

HyperDeck Shuttle - Press the play button when a clip is playing to initiate loop mode. Loop mode will continue until you press stop.

HyperDeck Studio - Enable loop mode during playback by pressing the play button. The display will show if loop mode is on or off.

Shuttling with HyperDeck Shuttle

If you're reviewing a long clip and need to quickly shuttle to a particular section, just hold down the Previous Clip or Next Clip button. This will allow you to reverse or fast forward through the clip at 2x speed. To go faster, press the Previous Clip or Next Clip button again and the speed will increase to 4x and then 8x. Once you've found the section you want to review, press Play and playback will resume at normal speed.

Jog and Shuttle with HyperDeck Studio

If you're reviewing a long clip and need to quickly shuttle to a particular section, press the reverse or fast forward button to play through the clip at 2x speed. To go faster, press the reverse or fast forward button again and the speed will increase to 4x and then 8x. Once you've found the section you want to review, press play to resume normal playback.

You can also use the Jog/Shuttle Wheel to shuttle to a particular section at variable speeds. The more you turn it forwards or backwards, the faster HyperDeck Studio will play through your video. Once you've found the section you want to review, press play to resume normal playback.

If you want to slowly jog through your video, frame by frame, press the JOG button once to enable jog operation. Turning the jog/shuttle wheel in the desired direction will then jog through your video. Pressing the JOG button again will return the wheel to shuttle operation.

18 Using HyperDeck

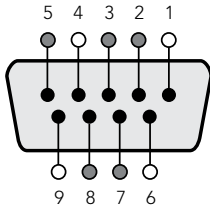

Receive (-)	Receive (+)	Transmit (-)	Transmit (+)	Ground Pins
2	7	8	3	1, 4, 6, 9

RS-422 remote pin connections.

RS-422 Control

What is RS-422 Control?

The RS-422 standard is commonly supported by NLE hardware and software and allows video players and recorders to be remotely controlled by an external RS-422 controller or capture device.

Using an External RS-422 Controller

HyperDeck Studio features an industry standard, Sony™ compatible, RS-422 deck control port which has the correct pin connections for a direct connection to any remote controller with RS-422.

You can use pre-manufactured 9 pin cables as long as each end of the cable is wired “pin for pin” where the same pin number on each end of the cable are connected together. If you would like to make custom cables, please refer to the accompanying wiring diagram.

You can remotely control HyperDeck Studio from an RS-422 controller, instead of locally pushing buttons.

- Step 1.** Connect a video signal to an SDI or HDMI video input of your HyperDeck Studio.
- Step 2.** Connect an RS-422 cable between your external controller and HyperDeck Studio.
- Step 3.** Press the REM button to enable remote deck control.

You can now remotely start and stop recording and playback of your HyperDeck Studio as well as performing other common jog and shuttle functions. The full list of supported RS-422 commands is in the following section named "Supported RS-422 Commands".

Daisy-chaining for Crash Recording

You can simultaneously record the same SDI video signal to multiple HyperDeck Studios. You'll need to press the REM button on each HyperDeck Studio to enable remote deck control. Each HyperDeck Studio can be set to record in a compressed or uncompressed video format using HyperDeck Utility.

If you're working with high definition video, you only need a single channel RS-422 controller connected to the first HyperDeck Studio and then loop the HD-SDI signal to the other HyperDeck Studios using the SDI loop output. Use HyperDeck Utility to set "Trigger recording" to "When SDI timecode runs" and all HyperDeck Studios will record the same video signal simultaneously.

If you ever work with standard definition video, you will need a multiple channel RS-422 controller connected to each HyperDeck Studio via RS-422. Connect a video signal to the SDI video input of one HyperDeck Studio and then loop the SD-SDI signal to the other HyperDeck Studios using the SDI loop output.

You can now use your external RS-422 controller to set multiple HyperDeck Studios to remotely crash record the same video signal.

19 Using HyperDeck

Supported RS-422 Commands

		Command	Reply	No Remote	Notes
0 - System Control					
0x00	0x11	DeviceTypeRequest	NTSC: 0xF0E0 PAL: 0xF1E0 24P: 0xF2E0	Enabled	
1 - Slave Response					
0x20	0x00	Stop	Acknowledge	Disabled	
0x20	0x01	Play	Acknowledge	Disabled	
0x20	0x02	Record	Acknowledge	Disabled	
0x20	0x10	FastFwd	Acknowledge	Disabled	
0x21	0x11	JogFwd1	Acknowledge	Disabled	
0x22	0x11	JogFwd2	Acknowledge	Disabled	Treated as N=1; Same as JogFwd1
0x21	0x12	VarFwd1	Acknowledge	Disabled	Uses ShuttleFwd1
0x22	0x12	VarFwd2	Acknowledge	Disabled	Treated as N=1; Same as VarFwd1
0x21	0x13	ShuttleFwd1	Acknowledge	Disabled	
0x22	0x13	ShuttleFwd2	Acknowledge	Disabled	Treated as N=1; Same as ShuttleFwd1
0x20	0x20	Rewind	Acknowledge	Disabled	
0x21	0x21	JogRev1	Acknowledge	Disabled	
0x22	0x21	JogRev2	Acknowledge	Disabled	Treated as N=1; Same as JogRev1
0x21	0x22	VarRev1	Acknowledge	Disabled	Uses ShuttleRev1
0x22	0x22	VarRev2	Acknowledge	Disabled	Treated as N=1; Same as VarRev1
0x21	0x23	ShuttleRev1	Acknowledge	Disabled	
0x22	0x23	ShuttleRev2	Acknowledge	Disabled	Treated as N=1; Same as ShuttleRev1
0x20	0x30	Preroll	Acknowledge	Disabled	
0x24	0x31	CueData	Acknowledge	Disabled	
0x20	0x34	SyncPlay	Acknowledge	Disabled	

20 Using HyperDeck

Supported RS-422 Commands

		Command	Reply	No Remote	Notes
0x21	0x38	ProgSpeedPlayPlus	Acknowledge	Disabled	
0x21	0x39	ProgSpeedPlayMinus	Acknowledge	Disabled	
0x20	0x40	Preview	Acknowledge	Disabled	Status bits are set
0x20	0x41	Review	Acknowledge	Disabled	Status bits are set
0x20	0x43	OutpointPreview	Acknowledge	Disabled	
0x22	0x5C	DMCSetFwd	Acknowledge	Disabled	
0x22	0x5D	DMCSetRev	Acknowledge	Disabled	
0x20	0x60	FullEEOff	Acknowledge	Disabled	
0x20	0x61	FullEEOn	Acknowledge	Disabled	
0x20	0x63	SelectEEOn	Acknowledge	Disabled	
4 - Preset/Select Control					
0x40	0x10	InEntry	Acknowledge	Disabled	
0x22	0x23	ShuttleRev2	Acknowledge	Disabled	Treated as N=1; Same as ShuttleRev1
0x20	0x30	Preroll	Acknowledge	Disabled	
0x24	0x31	CueData	Acknowledge	Disabled	
0x20	0x34	SyncPlay	Acknowledge	Disabled	
0x21	0x38	ProgSpeedPlayPlus	Acknowledge	Disabled	
0x21	0x39	ProgSpeedPlayMinus	Acknowledge	Disabled	
0x40	0x11	OutEntry	Acknowledge	Disabled	
0x44	0x14	InDataPreset	Acknowledge	Disabled	
0x44	0x15	OutDataPreset	Acknowledge	Disabled	
0x40	0x18	InFwd	Acknowledge	Disabled	
0x40	0x19	InRev	Acknowledge	Disabled	
0x40	0x1A	OutFwd	Acknowledge	Disabled	
0x40	0x1B	OutRev	Acknowledge	Disabled	
0x40	0x20	InReset	Acknowledge	Disabled	
0x40	0x21	OutReset	Acknowledge	Disabled	
0x40	0x22	AlnReset	Acknowledge	Disabled	

21 Using HyperDeck

Supported RS-422 Commands

		Command	Reply	No Remote	Notes
0x40	0x23	AOutReset	Acknowledge	Disabled	
0x44	0x31	PrerollPreset	Acknowledge	Disabled	
0x40	0x40	AutoModeOff	Acknowledge	Disabled	ignored, Status bit remembered
0x40	0x41	AutoModeOn	Acknowledge	Disabled	ignored, Status bit remembered
6 - Sense Request					
0x61	0x0A	TimeCodeGenSense			
		Request for Gen TC	GenTCData	Enabled	
		Timer1Sense	Timer1Data	Enabled	
		UserBitsVITCTimeSense	UserBitsVITCTimeData	Enabled	
		LTCUserBitsTimeSense	LTCUserBitsTimeData	Enabled	
		VITCUserBitsTimeSense	VITCUserBitsTimeData	Enabled	
0x60	0x10	InDataSense	InData	Enabled	
0x60	0x11	OutDataSense	OutData	Enabled	
0x60	0x12	AInDataSense	AInData	Enabled	
0x60	0x13	AOutDataSense	AOutData	Enabled	
0x61	0x20	StatusSense	StatusData	Enabled	
0x60	0x2E	SpeedSense	SpeedData	Enabled	
0x60	0x31	PrerollTimeSense	PreRollTimeData	Enabled	
0x60	0x36	TimerModeSense	TimerModeData	Enabled	
0x60	0x3E	RecordInhibitSense	RecordInhibitStatus	Enabled	

22 Using HyperDeck

Supported RS-422 Commands

		Command	Reply	No Remote	Notes
7 - Sense Reply					
0x78	0x00	Timer1Data	-	-	Current Time and 00:00:00:00
0x78	0x04	LTCUserBitsTimeData	-	-	Current Time and 00:00:00:00
0x78	0x06	VITCUserBitsTimeData	-	-	Current Time and 00:00:00:00
0x74	0x06	VITCTimeData	-	-	Current Time
0x74	0x07	UserBitsVITCTimeData	-	-	00:00:00:00
0x74	0x08	GenTCData	-	-	Current Time
0x78	0x08	GenTCUBData	-	-	Current Time and 00:00:00:00
0x74	0x09	GenUBData	-	-	00:00:00:00
0x74	0x10	InData	-	-	
0x74	0x11	OutData	-	-	
0x74	0x12	AInData	-	-	
0x74	0x13	AOutData	-	-	
0x74	0x14	CorrectedLTCTimeData	-	-	Current Time
0x70	0x20	StatusData	-	-	Please see "Status Bits" sheet: Limited to 9 bytes of status, silently truncated
0x71	0x2E	SpeedData	-	-	
0x74	0x31	PrerollTimeData	-	-	
0x71	0x36	TimerModeData	-	-	Returns 0 (TimeCode)
0x72	0x3E	RecordInhibitStatus	-	-	

23 Using HyperDeck

RS-422 Developer Information

	Bit 7	Bit 6	Bit 5	Bit 4	Bit 3	Bit 2	Bit 1	Bit 0
Byte 0	0	0	Cassette out	0	0	0	0	Local
Byte 1	Standby	0	Stop	0	Rewind	Forward	Record	Play
Byte 2	Servo Lock	0	Shuttle	Jog	Var	Direction	Still	1
Byte 3	Auto Mode	0	0	0	Aout Set	Ain Set	Out Set	In Set
Byte 4	Select EE	Full EE	0	0	0	0	0	0
Byte 5	0	0	0	0	0	0	0	0
Byte 6	0	Lamp Still	Lamp Fwd	Lamp Rev	0	0	0	0
Byte 7	0	0	0	0	0	0	0	0
Byte 8	0	0	Near EOT	EOT	0	0	0	0
Byte 9	0	0	0	0	0	0	0	0

Variables	
Cassette Out	Set if no SSD is present
Local	Set if Remote is disabled (local control)
Standby	Set if a disk is available
Direction	Clear if playback is forwarding, set if playback is reversing
Still	Set if playback is paused, or if in input preview mode
Auto Mode	Set if in Auto Mode
Select EE, Full EE	Set if in input preview mode
Lamp Still/Fwd/Rev	Set according to playback speed and direction
Near EOT	Set if total space left on available SSDs is less than 3 minutes
EOT	Set if total space left on available SSDs is less than 30 seconds

Others	
Cue Complete (byte 2, bit 0)	Always 1: Cue requests are always instantaneous

HyperDeck Serial RS-422 Protocol		
Protocol	Based on Sony 9-pin protocol	
Interface	Baud rate	38.4 kBits/s
	1 start bit	
	8 data bits	
	1 stop bit	
	1 parity bit	
	Odd parity	

24 Using HyperDeck Shuttle

HyperDeck Shuttle Controls

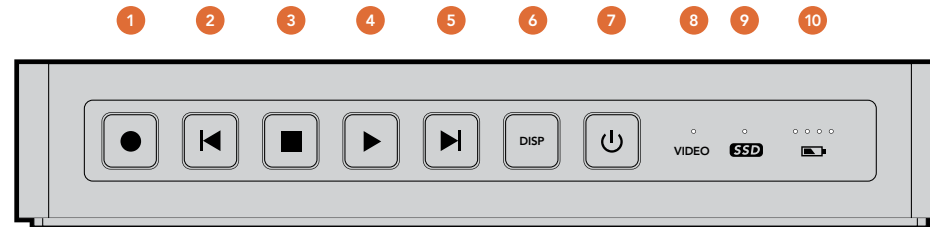

Buttons

1. Record

HyperDeck Shuttle will instantly record the moment you press the Record button, even if you're playing back a clip. This means you'll never miss a good take that's happening. If the button flashes red, the SSD is too slow and cannot keep up with recording.

2. Previous Clip

If you hold down the Previous Clip, the clip will reverse at 2x speed. Pressing the button again will increase the speed to 4x and 8x. If you want to resume playing back at normal speed, just press the Play button. Or you can press the Stop button to pause when reversing.

3. Stop

The Stop button also switches HyperDeck Shuttle between playback and video loop through mode.

4. Play

When a clip is playing, pressing Play again will loop it continuously.

5. Next Clip

If you hold down Next Clip, the clip will fast forward at 2x speed. Pressing the button again will increase the speed to 4x and 8x. If you want to resume playing back at normal speed, just press the Play button. Or you can also press the Stop button to pause when fast forwarding.

6. DISP

This button isn't currently used but will soon be enabled by a software update. You will be able to download this for free at www.blackmagicdesign.com

7. Power On/Off

The Power button turns the HyperDeck Shuttle on or off. To prevent someone from accidentally switching off the unit, you must hold the Power button down for 2 seconds to turn it off. If you're running off the built-in batteries, the unit will turn itself off to conserve power after 8 minutes if you're not recording.

Status Indicators

8. VIDEO

The VIDEO indicator lights up when a video signal is detected by HyperDeck Shuttle.

9. SSD

The SSD indicator lights up in green when it is accessing a correctly formatted SSD. If the SSD has not been formatted correctly, or fails to work, the SSD light will illuminate solid red until the SSD is removed.

10. Battery

The four green battery indicators display the internal battery charge level. When all the LEDs go off, there's approximately 4 minutes of battery power left. So you should plug in your external power source or switch to another charged HyperDeck Shuttle.

25 Using HyperDeck Shuttle

HyperDeck Shuttle Connections

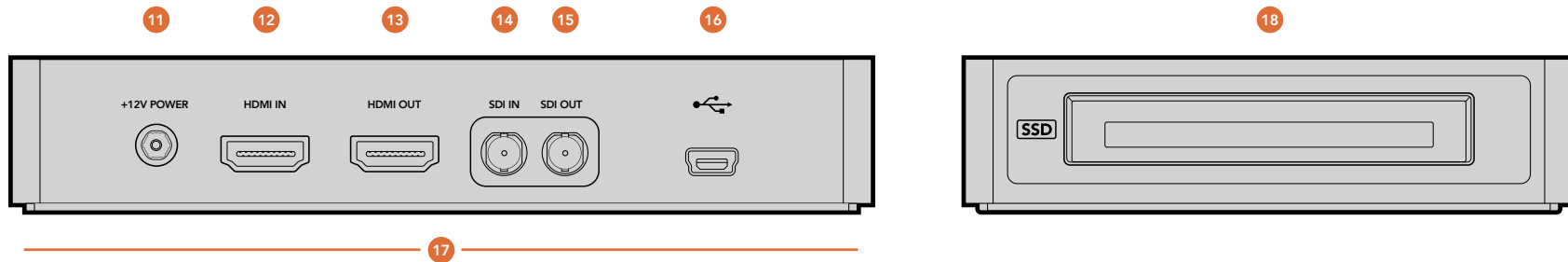

Connections

11. +12V POWER

You can use the power adapter supplied with HyperDeck Shuttle or power it off an external camera battery as the connector supports an input range of 12V to 18V. When a power source is connected, the built-in internal battery will also be charged.

12. HDMI IN

You can connect your HDMI video sources to this input – such as a camera, games console and the output of an ATEM switcher.

13. HDMI OUT

Connect an HDMI display or TV to this output to monitor your video while recording or playing back clips. You can also connect this output to the HDMI input of capture cards, production switchers and other recording devices.

14. SDI IN

You can connect your SDI video sources, such as cameras, routers, capture cards, switcher outputs or decks to this input. A DIN 1.0/2.3 miniature connector is used for SDI input. A short DIN 1.0/2.3 to BNC adapter cable can be used to connect to SDI cables with BNC connectors.

15. SDI OUT

Connect this output to monitors, routers, production switchers, decks or other recording devices. A DIN 1.0/2.3 miniature connector is used for SDI output. A short DIN 1.0/2.3 to BNC adapter cable can be used to connect to SDI cables with BNC connectors.

16. USB 2.0

Use the USB Mini-B port for software configuration and updates.

Mounts

17. Rubber Mat or HyperDeck Shuttle Mounting Plate

HyperDeck Shuttle has a non-slip rubber base for use on a desk. If you want to mount HyperDeck Shuttle on a camera or tripod, the base can be removed and replaced with an optional HyperDeck Shuttle Mounting Plate that is available for purchase from Blackmagic Design resellers.

SSD Slot

18. SSD Slot

Insert a 2.5" SSD into the SSD slot until you feel the SSD press into place. Hard drives are not supported and should not be used. To remove the SSD, simply pull it out.

26 Using HyperDeck Shuttle

The contents of the box includes:

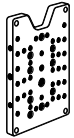

x1
HyperDeck Shuttle
Mounting Plate

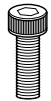

x4
Socket Head Screws
M3 x 10mm

You will need:



x1
Hex Allen Key 2.5mm
(not included)

Installing the HyperDeck Shuttle Mounting Plate

HyperDeck Shuttle Mounting Plate is an optional accessory which lets you secure your HyperDeck Shuttle to a camera rig with your choice of rail mounts, cold shoe mounts, articulated arms and more. You can also use the plate to power your HyperDeck Shuttle from an external battery by attaching a V-Mount or Anton Bauer style battery plate. HyperDeck Shuttle Mounting Plate is available for purchase from Blackmagic Design resellers. For easy installation, please follow these simple steps.

- Step 1.** Peel back the rubber mat from all four corners of the base so you can just see the screws. Remove all four screws.
- Step 2.** Remove the base.
- Step 3.** Attach your HyperDeck Shuttle Mounting Plate using the supplied socket head screws.

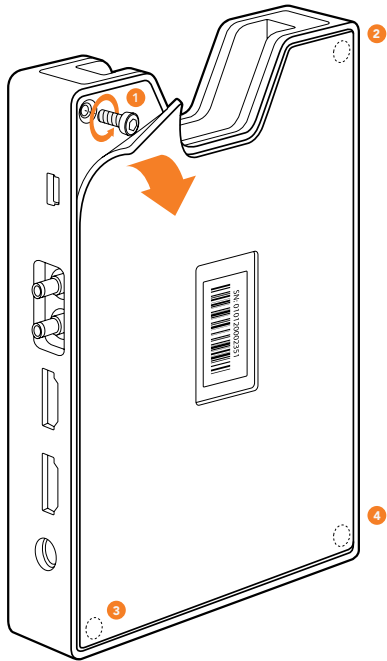

Step 1

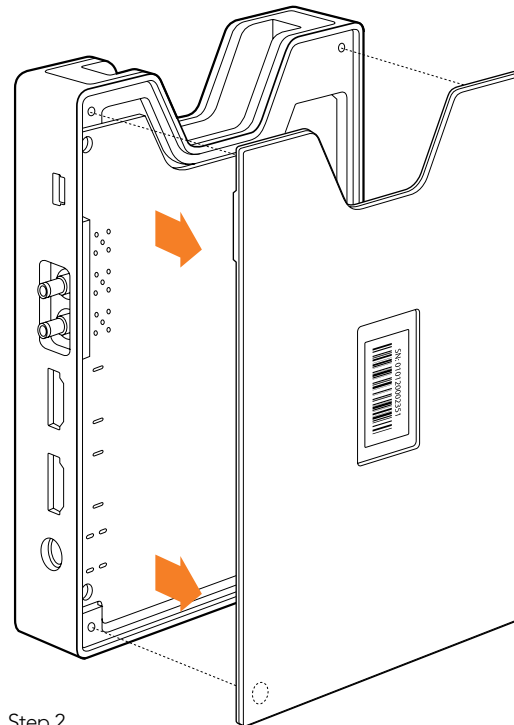

Step 2

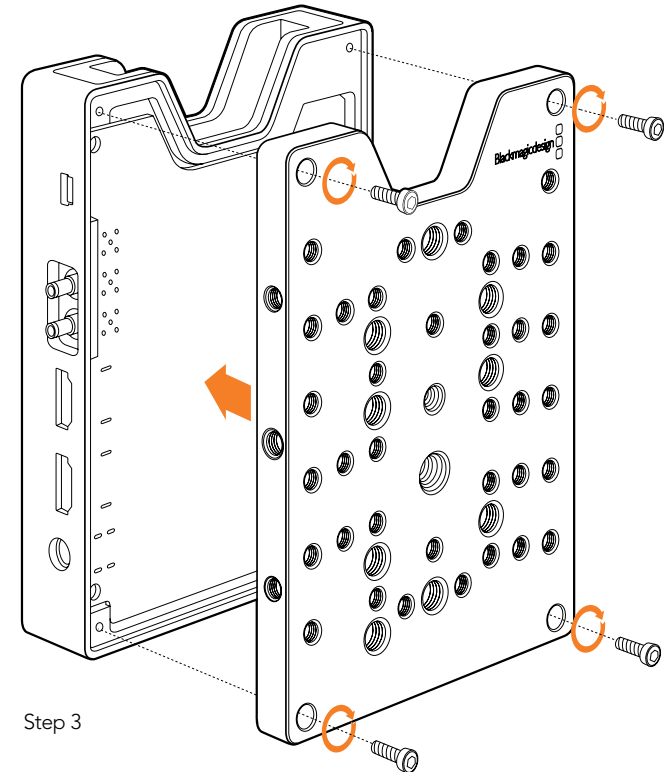

Step 3

HyperDeck Studio Controls

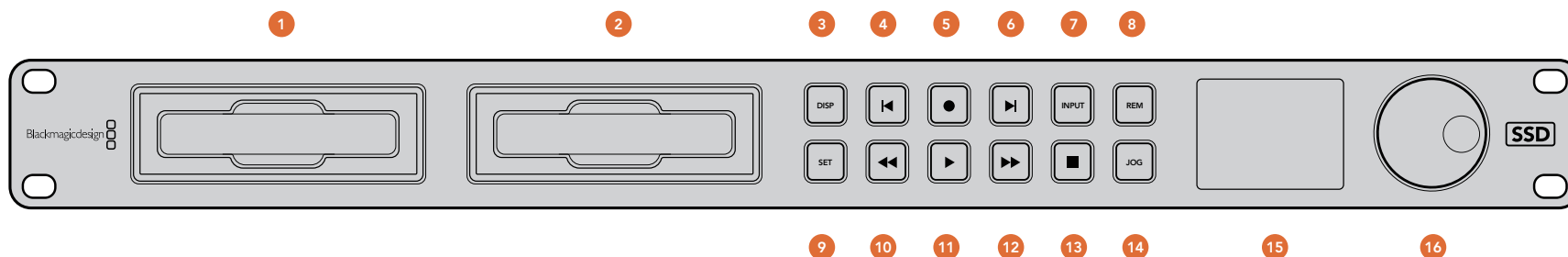

SSD Slots

1. SSD Slot 1

2. SSD Slot 2

Insert a 2.5" SSD into an SSD slot until you feel the SSD press into place. The surround of the SSD slot lights in green when it is accessing a correctly formatted SSD. If the SSD has not been formatted correctly, or fails to work, the SSD slot light will illuminate solid red until the SSD is removed. Hard drives are not supported and should not be used. To remove the SSD, simply pull it out.

Buttons and Controls

3. DISP

This button isn't currently used but will soon be enabled by a software update.

4. Previous Clip

Press once to go to the start of the current clip or press twice to skip back to the start of the previous clip.

5. Record

Recording commences the instant you press the record button, even if you're playing back a clip, so you'll never miss a good take that's happening. If the button flashes red,

the SSD is too slow and cannot keep up with recording. To switch from one SSD to the other while recording, press the record button for 1 second.

6. Next Clip

Press to skip to the next clip.

7. INPUT

While the stop button is illuminated, press the INPUT button once to display the incoming video on the LCD. If you don't see the video you want, press the button again to switch between the HDMI and SDI inputs.

8. REM

Push REM to enable RS-422 remote control or to allow remote trigger recording via SDI.

9. SET

This button isn't currently used but will soon be enabled by a software update.

10. Reverse

Press once to play in reverse at normal speed. Press again to reverse at 2x, 4x and 8x speeds.

11. Play

Press once to play through all clips or press again to loop the current clip.

12. Fast Forward

Press once to play at 2x speed or press again to play at 4x and 8x speeds.

13. Stop

Stop works in all modes.

14. JOG

Press once to use the jog wheel to scroll through video or press again to set the jog wheel to shuttle mode.

15. LCD

The color LCD displays video format, timecode, audio meters, video preview, transport controls and the active SSD.

16. Jog/Shuttle Wheel

Use with the JOG button to jog or shuttle forwards and backwards.

28 Using HyperDeck Studio

HyperDeck Studio Connections

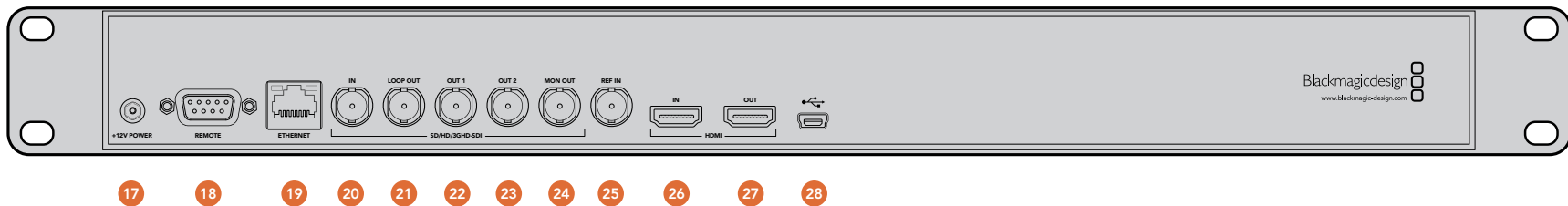

Connections

17. +12V POWER

You can use the universal power adapter supplied with HyperDeck Studio or power it off any DC power source, from 12V to 18V, allowing for portable battery packs and on set use.

18. REMOTE

RS-422 remote control.

19. ETHERNET

This port isn't currently used but will soon be enabled by a software update.

20. SD/HD-SDI IN

You can connect your SD/HD-SDI video sources, such as cameras, routers, capture cards, switcher outputs or decks to this input.

21. SD/HD-SDI LOOP OUT

This output is relocked from the video input and can be connected to other devices such as a monitor or a second HyperDeck for redundant recording.

22. SD/HD-SDI OUT 1

Connect this output to monitors, routers, capture cards, production switchers, decks or other recording devices.

23. SD/HD-SDI OUT 2

Connect this output to monitors, routers, production switchers, decks or other recording devices.

24. SD/HD-SDI MON OUT

SD/HD-SDI output for monitoring.

25. REF IN

This input accepts blackburst and tri-level sync signals from a sync generator.

26. HDMI IN

You can connect your HDMI video sources to this input – such as a camera, games console or the output of an ATEM switcher.

27. HDMI OUT

Connect an HDMI display or TV to this output to monitor your video while recording or playing back clips. You can also connect this output to the HDMI input of capture cards, production switchers and other recording devices.

28. USB 2.0

Use the USB Mini-B port for software configuration and updates.

Getting Help

The fastest way to obtain help is to go to the Blackmagic Design online support pages and check the latest support material available for your HyperDeck.

Blackmagic Design Online Support Pages

The latest manual, software and support notes can be found at the Blackmagic Support Center at www.blackmagicdesign.com/support.

Contacting Blackmagic Design Support

If you can't find the help you need in our support material, please use the "Send request" button, on the support page for your HyperDeck model, to email a support request. Alternatively call your nearest Blackmagic Design support office at www.blackmagicdesign.com/company.

Checking the Software Version Currently Installed

To check which version of HyperDeck Utility software is installed on your computer, open the About Blackmagic HyperDeck Utility window.

- On Mac OS X, open Blackmagic HyperDeck Utility from the Applications folder. Select About Blackmagic HyperDeck Utility from the application menu to reveal the version number.
- On Windows 7, open Blackmagic HyperDeck Utility from your Start menu. Click on the Help menu and select About Blackmagic HyperDeck Utility to reveal the version number.

How to Get the Latest Software Updates

After checking the version of HyperDeck Utility software installed on your computer, please visit the Blackmagic Support Center at www.blackmagicdesign.com/support to check for the latest updates. While it is usually a good idea to run the latest updates, it is a wise practice to avoid updating any software if you are in the middle of an important project.

12 Month Limited Warranty

Blackmagic Design warrants that this product will be free from defects in materials and workmanship for a period of 12 months from the date of purchase. If a product proves to be defective during this warranty period, Blackmagic Design, at its option, either will repair the defective product without charge for parts and labor, or will provide a replacement in exchange for the defective product.

In order to obtain service under this warranty, you the Customer, must notify Blackmagic Design of the defect before the expiration of the warranty period and make suitable arrangements for the performance of service. The Customer shall be responsible for packaging and shipping the defective product to a designated service center nominated by Blackmagic Design, with shipping charges pre paid. Customer shall be responsible for paying all shipping charges, insurance, duties, taxes, and any other charges for products returned to us for any reason.

This warranty shall not apply to any defect, failure or damage caused by improper use or improper or inadequate maintenance and care. Blackmagic Design shall not be obligated to furnish service under this warranty: a) to repair damage resulting from attempts by personnel other than Blackmagic Design representatives to install, repair or service the product, b) to repair damage resulting from improper use or connection to incompatible equipment, c) to repair any damage or malfunction caused by the use of non Blackmagic Design parts or supplies, or d) to service a product that has been modified or integrated with other products when the effect of such a modification or integration increases the time or difficulty of servicing the product. THIS WARRANTY IS GIVEN BY BLACKMAGIC DESIGN IN LIEU OF ANY OTHER WARRANTIES, EXPRESS OR IMPLIED. BLACKMAGIC DESIGN AND ITS VENDORS DISCLAIM ANY IMPLIED WARRANTIES OF MERCHANTABILITY OR FITNESS FOR A PARTICULAR PURPOSE. BLACKMAGIC DESIGN'S RESPONSIBILITY TO REPAIR OR REPLACE DEFECTIVE PRODUCTS IS THE WHOLE AND EXCLUSIVE REMEDY PROVIDED TO THE CUSTOMER FOR ANY INDIRECT, SPECIAL, INCIDENTAL OR CONSEQUENTIAL DAMAGES IRRESPECTIVE OF WHETHER BLACKMAGIC DESIGN OR THE VENDOR HAS ADVANCE NOTICE OF THE POSSIBILITY OF SUCH DAMAGES. BLACKMAGIC DESIGN IS NOT LIABLE FOR ANY ILLEGAL USE OF EQUIPMENT BY CUSTOMER. BLACKMAGIC IS NOT LIABLE FOR ANY DAMAGES RESULTING FROM USE OF THIS PRODUCT. USER OPERATES THIS PRODUCT AT OWN RISK.

© Copyright 2012 Blackmagic Design. All rights reserved. 'Blackmagic Design', 'DeckLink', 'HDLink', 'Workgroup Videohub', 'Multibrige Pro', 'Multibrige Extreme', 'Intensity' and 'Leading the creative video revolution' are registered trademarks in the US and other countries. All other company and product names may be trade marks of their respective companies with which they are associated.