



Installation and Operation Manual

SmartView & SmartScope

September 2020

English, 日本語, Français, Deutsch, Español, 中文, 한국어, Русский, Italiano, Português and Türkçe.

Languages

To go directly to your preferred language, simply click on the hyperlinks listed in the contents below.

English	3
日本語	42
Français	82
Deutsch	122
Español	162
中文	202
한국어	242
Русский	282
Italiano	322
Português	362
Türkçe	402



Welcome!

We hope you share our dream for the television industry to become a truly creative industry by allowing anyone to have access to the highest quality video.

Video monitoring is needed everywhere in a facility. SmartView 4K has a native 4K LCD so you can monitor Ultra HD video in full resolution, plus a sleek 6RU housing with a control panel that lets you quickly change settings. SmartView HD provides an amazing 17" LCD in a 6RU rack housing less than an inch thick. SmartView Duo provides two completely independent and beautiful 8 inch LCDs in a 3RU rack housing less than an inch thick. SmartScope Duo 4K features two independent 8" LCDs with waveform scope functionality, allowing you to monitor your video levels on the fly. All SmartView monitors support SD, HD and 2K video via 3G-SDI. SmartScope Duo 4K and SmartView 4K also support Ultra HD 4K via 6G-SDI and 12G-SDI respectively!

Video monitoring is designed to work straight out of the box and our Blackmagic SmartView setup software provides the user with an easy and intuitive configuration tool.

This instruction manual should contain all the information you'll need on installing your SmartView or SmartScope, although it's always a good idea to ask a technical assistant for help if you are not sure what IP addresses are, or if you don't know much about computer networks. SmartView and SmartScope are easy to install, however, there are a few slightly technical preferences you may need to set after you install it.

We think it should take you approximately 5 minutes to complete Installation. Please check our website at www.blackmagicdesign.com and click the support page to download the latest updates to this manual and SmartView software. Lastly, please register your unit when downloading software updates so we can keep you updated when new software is released. We are constantly working on new features and improvements, so we would love to hear from you!

A handwritten signature of Grant Petty in black ink. The signature is written in a cursive, flowing style with a prominent 'G' and 'P'.

Grant Petty

CEO Blackmagic Design

Contents

SmartView & SmartScope

Getting Started	5
Introducing SmartView and SmartScope	5
Plugging in Video Sources	6
Plugging in your Computer	6
Installing Blackmagic SmartView Setup	7
Using Blackmagic SmartView Setup	8
Updating the Software	8
Adjusting Monitor Settings	8
Enable Tally Override	11
Using SmartView 4K	11
Introducing Blackmagic SmartView 4K	11
Control Panel Buttons	12
Loading 3D LUTs using Blackmagic SmartView Setup	14
Using SmartScope Duo 4K	15
What is Blackmagic SmartScope?	15
Video Monitoring Display	16
Waveform Display	17
Vectorscope Display	18
Parade Display	19
Histogram Display	21
Audio Metering Display	22
Connecting to a Network	23
Direct Ethernet	23
Ethernet Network Switch	24
Adjusting Network Settings	25
Network Settings	25
Adding a Blackmagic Monitor	27
Using Tally	28
Tally Port Pin Connections	28
Optimizing the Viewing Angle	29
Developer Information	31
Blackmagic 2K Format – Overview	31
Blackmagic 2K Format – Vertical Timing Reference	32
Blackmagic 2K Format – Data Stream Format	33
Blackmagic SmartView Ethernet Protocol v1.3	34
Help	38
Regulatory Notices	39
Safety Information	40
Warranty	41

Getting Started

Introducing SmartView and SmartScope

SmartView monitors are perfect for any facility which requires rack-based monitoring. To simply get up and running, the only thing you need to do is plug in power and connect an SDI source!

SmartView 4K has a 15.6" 4K LCD so you can monitor SD, HD, or Ultra HD video in its native 3840x2160 pixel resolution. The front control panel buttons mean you can easily select inputs, adjust the screen brightness, check for noise in the blue channel, view blanking information, apply 3D LUTs and more.

SmartView HD has a 17" HD LCD which is perfect for confidence monitoring in full resolution HD.

SmartView Duo has two monitors for simultaneous display of different video signals. For example, one monitor can display a YUV 4:2:2 signal while the other receives RGB 4:4:4. One monitor could be showing NTSC while the other shows PAL. There are many possible combinations but it is all as simple as connecting a single SDI cable to each monitor!

SmartScope Duo 4K has all the same features as SmartView Duo plus can be used to display waveform, vectorscope and other popular scopes for monitoring video and audio levels in real time. Plus, you get full support for Ultra HD 4K!

All SDI input connections on SmartView and SmartScope monitors support auto detection of SD, HD or 3G-SDI including 2K video. SmartView 4K also detects Ultra HD including formats such as 2160p60 via 12G-SDI. SmartScope Duo 4K includes auto detection of Ultra HD 4K video via 6G-SDI.

If you want to remotely adjust settings for multiple SmartView and SmartScope units from one computer, you can connect them together via Ethernet. This means you won't have to run around to each unit with a computer and USB cable each time you want to adjust settings.

That's all you need to get started! Please read on for more detailed instructions on connecting SmartView and SmartScope, configuring monitor settings in Blackmagic SmartView setup, and connecting to a network.



SmartView 4K



SmartView HD



SmartView Duo



SmartScope Duo 4K

Plugging in Video Sources

SmartView and SmartScope monitors feature regular BNC connectors to connect to SDI equipment including switchers, cameras, capture cards, decks and disk recorders.

Getting a Picture

Displaying your video is easy! Simply power the unit and connect your video source to an SDI input. Once powered and connected, your video should be immediately visible. SD, HD and 2K signals are automatically detected by the SDI input and loop through output connections. SmartView 4K and SmartScope Duo 4K also detects Ultra HD 4K.

When no video is received by the unit, the backlight turns off, saving power until the next valid signal is received.

Daisy chaining Monitors

Each SmartView and SmartScope monitor has its own independent SDI input as well as a loop through output so you can chain multiple monitors together to display the same input signal:

- 1 Power on unit 1. Connect a video source to an SDI input. The video should immediately be visible.
- 2 Power on unit 2. Connect an SDI cable from a loop output of unit 1 to an SDI input on unit 2.

There is no limit to the amount of units you can chain.

If you are waveform monitoring using SmartScope Duo 4K, you'll probably want to loop the Monitor 1 output to Monitor 2 so both displays use the same input signal.

Now you have video displayed, you can adjust monitor settings, or select scopes on SmartScope Duo 4K using the Blackmagic SmartView setup software, which you can also use to load 3D LUTs on Blackmagic SmartView 4K.



SmartView 4K

SmartView HD

SmartView Duo

SmartScope Duo 4K

Plugging in your Computer

Configure SmartView or SmartScope monitor settings by connecting to your computer via USB and installing Blackmagic SmartView setup.

The USB connection can also be used for applying internal software updates downloaded from the Blackmagic Design website. Software updates can provide new features, compatibility with new hardware and support for new formats. Blackmagic SmartView setup software runs on both macOS and Windows computers.

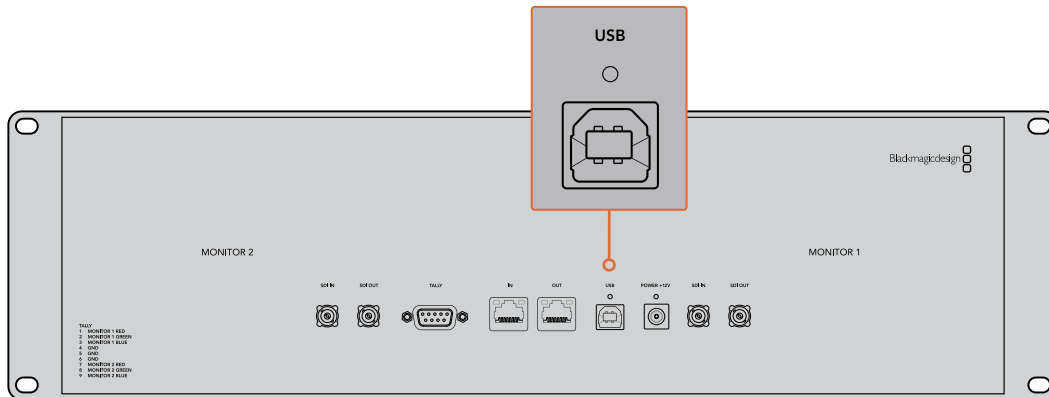

Installing Blackmagic SmartView Setup

Blackmagic SmartView setup runs on the latest Sierra and High Sierra versions of macOS, and 64-bit versions of Windows 8.1 and 10 with the latest service packs installed. Blackmagic SmartView setup can be installed on multiple networked computers if desired.

The SD card supplied with SmartView contains the software installer, but we recommend visiting www.blackmagicdesign.com/support to ensure you have the latest version.

To install on macOS:

Open the supplied SD card, or downloaded disk image, and double click on the install SmartView icon. A SmartView folder will be created in your applications folder, containing SmartView setup, an uninstaller for removing previous versions when updating, and a documents folder containing this manual plus other SmartView information.

To install on Windows:

On Windows, open the supplied SD card, or downloaded zip file, and double-click on the SmartView installer. Follow the onscreen prompts to install the software.

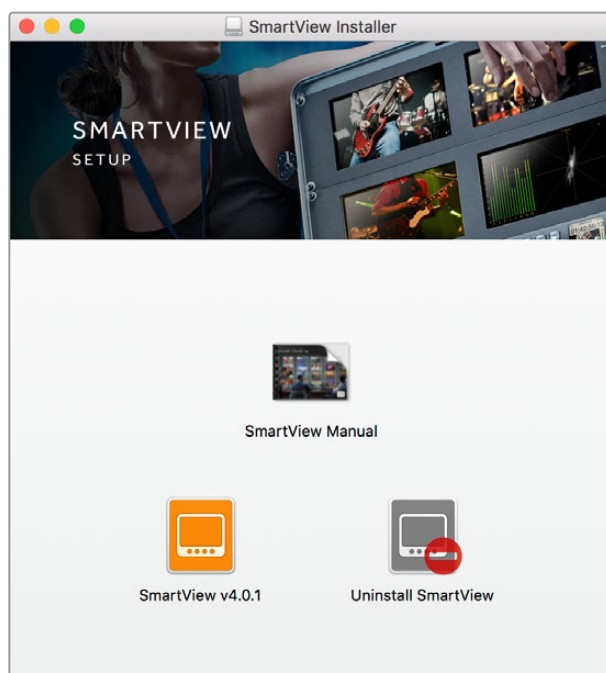

To install on macOS, launch the SmartView.dmg file on the supplied SD card, or from your downloads folder, then double click on the install SmartView icon

Using Blackmagic SmartView Setup

Updating the Software

Once Blackmagic SmartView setup is installed and launched, click on the settings icon below the name of your monitor. You may be prompted to update the internal software of your SmartView or SmartScope. To do so:

- 1 Connect your SmartView or SmartScope to the computer via USB or Ethernet and launch Blackmagic SmartView setup.
- 2 When prompted, simply click update. The update may take about 5 minutes to complete.
- 3 The message: “This SmartView has been updated” should appear upon completion of the update.
- 4 Click close.

If no internal software update is required, Blackmagic SmartView setup will open the settings page for your monitor.

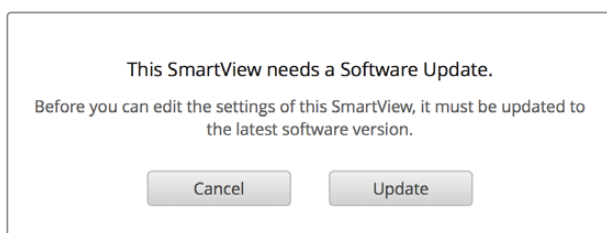

When launching SmartView setup and opening the settings icon for your connected SmartView or SmartScope, this message will appear if an internal software update is required

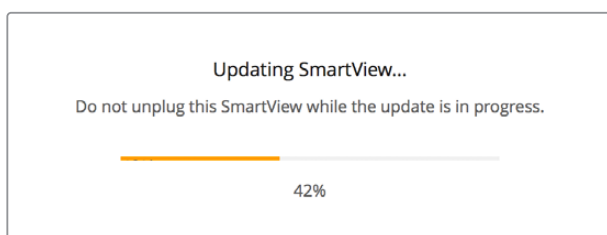

The update will take about 5 minutes to complete

Adjusting Monitor Settings

When launched, Blackmagic SmartView setup will immediately search for any SmartView or SmartScope units connected via USB or Ethernet and display them in the SmartView setup home page. If you have more than one Blackmagic monitor connected to your network, click on the left and right arrow icons on each side of the home page to select the monitor you want to adjust. If your Blackmagic monitor is connected via USB, a USB icon will appear next to the monitor name.

To adjust settings, select your monitor connected via Ethernet and USB, and click on the settings icon below the monitor name. This will open the settings page for your selected monitor. When you are happy with your settings, click the save button to save your settings and return to the SmartView setup home page.

See the next section for information on settings that are available for Blackmagic monitors and how to apply them. For information on how to configure network settings using Blackmagic SmartView setup, turn to the section “adjusting network settings”.

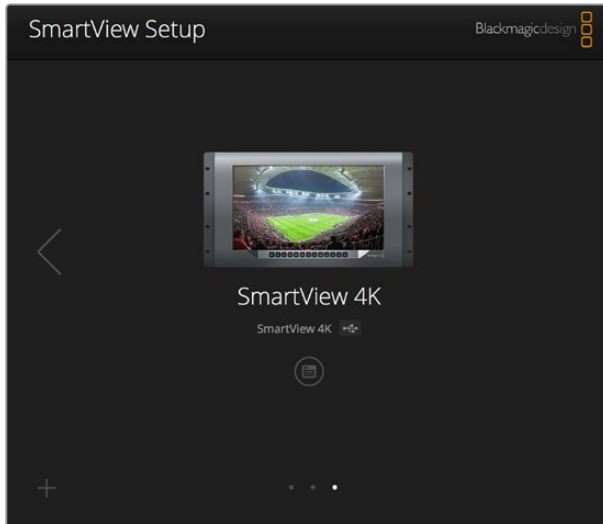

Blackmagic SmartView setup automatically searches for any SmartView and SmartScope units connected locally via USB or over a network. When updating your monitor’s internal software make sure your monitor is connected via USB or Ethernet. A USB icon will appear next to your monitor’s name.

Monitor Settings

To adjust settings and displays for each monitor, they must be connected via Ethernet or USB. Select the monitor you wish to set by clicking on the left and right arrow icons on the SmartView setup home page, then clicking on the settings icon under your monitor name. The settings page is automatically customized to suit the features supported by your selected Blackmagic monitor.

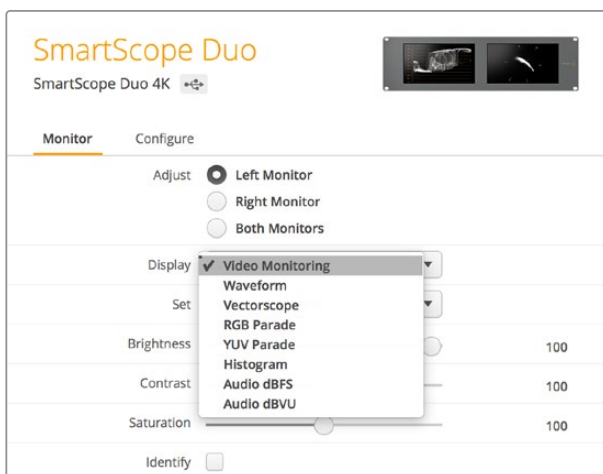

With SmartScope you can select between scopes or video monitoring from the ‘display’ drop down menu

Adjust

When using a SmartScope or SmartView Duo, choose the monitor you want to adjust by selecting 'left monitor', 'right monitor', or 'both monitors' to adjust both at the same time. When the 'both monitors' setting is enabled, any adjustments to brightness, contrast and saturation will be applied to both monitors on SmartView Duo and SmartScope.

Display

When using a SmartScope, the 'display' drop down menu provides selectable scopes. Select 'video monitoring' if you just want to see the video image.

Set

When using a SmartScope, the 'set' drop down menu lets you select 4:3 or 16:9 aspect ratios for the video monitoring display when using standard definition video. The 'set' drop down menu provides additional options for the selected display, including vectorscope, audio dBFS and audio dBVU options.

- **Video Monitoring:** Select to view the video image using 4:3 or 16:9 aspect ratios. When viewing widescreen anamorphic standard definition video, choose the 16:9 aspect ratio. When viewing traditional 4:3 standard definition video, choose the 4:3 aspect ratio.
- **Vectorscope:** Select whether your input is based on 100% or 75% color bar test signals.
- **Audio dBFS:** Select which pair of audio channels to monitor phase.
- **Audio dBVU:** Select which pair of audio channels to monitor phase.

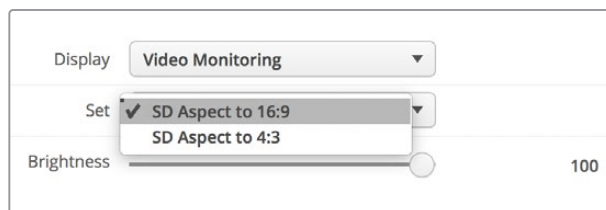

Set "SD Aspect to 16:9" when viewing anamorphic standard definition video

Brightness, Contrast, Saturation

Adjust the sliders to apply brightness, contrast and saturation settings. The settings available will differ between SmartView and SmartScope models.

Identify Monitor

When the 'identify' checkbox is enabled, any monitor selected in Blackmagic SmartView setup will display a white border. If several SmartView and SmartScope units are connected via a network, this setting makes it easy to visually identify the selected monitor.

If this setting is used in conjunction with the 'both monitors' setting, the white border will be displayed on both SmartView Duo or SmartScope Duo 4K monitors.

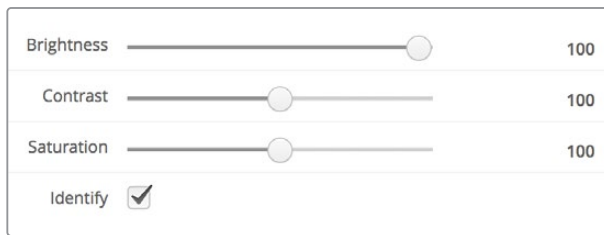

Drag the sliders left and right to adjust brightness, contrast and saturation settings. Check the Identify setting to visually identify your selected monitor.

Enable Tally Override

Select 'enable tally override' to enable tally borders on Blackmagic SmartView 4K. This feature is compatible with Blackmagic URSA Mini Pro 4.6K and Blackmagic URSA Broadcast.

Connect the camera's SDI output to input A or B on your SmartView 4K.

Connect the ATEM switcher's program output to the camera's SDI input.

When the ATEM switcher switches the camera to the program output, a red tally border will appear on your SmartView 4K. When switched to the preview output, the tally border will appear green

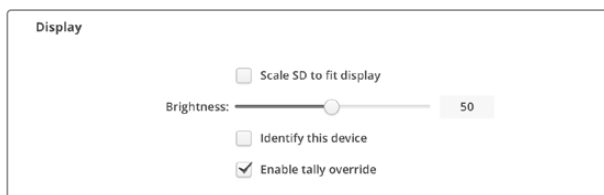

Click on the 'enable tally override' checkbox to display tally borders on SmartView 4K when connected to a Blackmagic URSA Mini Pro or URSA Broadcast camera

Using SmartView 4K

Introducing Blackmagic SmartView 4K

SmartView 4K is a 6 rack unit Ultra HD 12G-SDI broadcast monitor for displaying SD, HD and native viewing of up to 2160p60 Ultra HD video. With a bright display and a wide viewing angle, SmartView 4K provides a vibrant, crystal clear picture for accurate focus and color monitoring, and supports virtually every video format.

Designed for studio and outside broadcast environments, SmartView 4K is incredibly easy to use. Featuring side mounted connectors and VESA support, you can fit the unit into tight spaces, or mounted on a wall or articulated arm. SmartView 4K can be operated using the built in control panel, or remotely via Ethernet if you don't have access to the front panel.

Two multi rate 12G-SDI inputs let you select between two SDI sources, plus a SMPTE compatible SFP module socket so you can add an optical fiber SDI module and connect your video via optical fiber! A 12G-SDI output is provided so you can feed your video to other equipment, plus two Ethernet connectors for networking, remote control and loop output for daisy chaining to other monitors. Other connectors include a tally input for live production, and a USB port for internal software updates.

You can even load industry standard 3D LUTs with .cube extension or DaVinci Resolve generated LUTs using the Blackmagic SmartView setup software! With 3D LUTs you can connect your SmartView 4K directly to your camera and view your clips as close to the final grade as possible. Two levels of focus peaking let you make sure your shots are in perfect focus, and with support for AC and DC power you have the option to plug SmartView 4K into mains power, or an external battery for portability on set.

SmartView 4K is the perfect monitoring solution for portable and studio broadcast production displaying video in SD, HD, and Ultra HD in its native 3840x2160 pixel resolution.



NOTE If connecting external power via the DC power input, ensure your external power output is capable of supplying 24 watts at 12 volts.

Control Panel Buttons

The control panel features a row of buttons so you can quickly adjust settings on your SmartView 4K.

Input

Pressing this button cycles through the video signals connected to SmartView 4K's two 12G-SDI inputs and optional optical fiber SFP module input. If there is no video connected to an input, SmartView 4K will display black for that input. When switching between inputs, information about your connected input format will be momentarily displayed on the top left corner of your monitor.

Disp

The 'disp' button is used to adjust the brightness setting on your SmartView 4K's LCD. Adjust brightness by pressing the up and down arrow buttons. Press the 'disp' button again to close the setting.

H/V Delay

Pressing the 'H/V delay' button lets you quickly confirm the presence of ancillary data embedded in your SDI video signal. For example, press the H/V delay button once to view the horizontal ancillary data. Press the H/V delay button again to view the vertical ancillary data, commonly used for data such as closed captions.

Blue Only

If there is noise in a digital video signal, it is prominently within the blue channel. You can easily check for noise in your blue channel by pressing the 'blue only' button. This displays only the blue channel represented as a black and white image. This black and white image can also be used for assistance when checking camera focus.

Zoom

A method of achieving crisp camera focus is to use the 'zoom' button. Press once to zoom into the image. Now you can see clearly if an object is in focus. Press zoom again to return to normal viewing size.

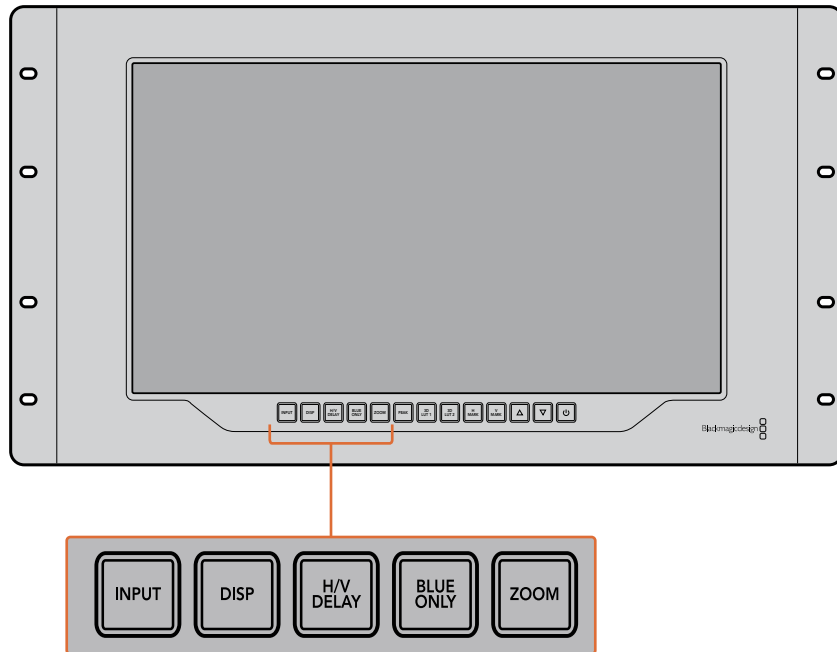

Peak

Camera focus can easily be checked by pressing the 'peak' button to enable focus peaking. This displays a bright green edge around the sharpest points in your image. There are two levels of peaking strengths which you can cycle through with subsequent pressing of the peak button. When the green edges are at their strongest, you can be sure your camera is in focus.

3D LUT 1 and 3D LUT 2

The LUT buttons let you view your image using custom 3D LUTs generated in Blackmagic DaVinci Resolve, or industry standard .cube LUTs. Press a LUT button once to enable the LUT. Press again to disable the LUT. Refer to the 'loading 3D LUTs using Blackmagic SmartView setup' section for more information on using 3D LUTs with SmartView 4K.

H Mark and V Mark

You can view and edit frame markers using the 'H Mark' and 'V Mark' buttons. Frame markers help you compose shots or keep important information or graphics within the safe area of the screen. Different televisions display slightly more or less of the edges of a video signal, so it's handy to view a safe area. A safe area is the section of the screen that will always be visible no matter what television or monitor is being used to view it.

To view horizontal and vertical frame markers, press the H Mark and V Mark buttons respectively. To edit the markers, press each respective button again to highlight each guide. This allows you to edit the markers' positions using the up and down arrow buttons. Subsequent presses of each button will confirm your new positions. Another press turns the markers off.

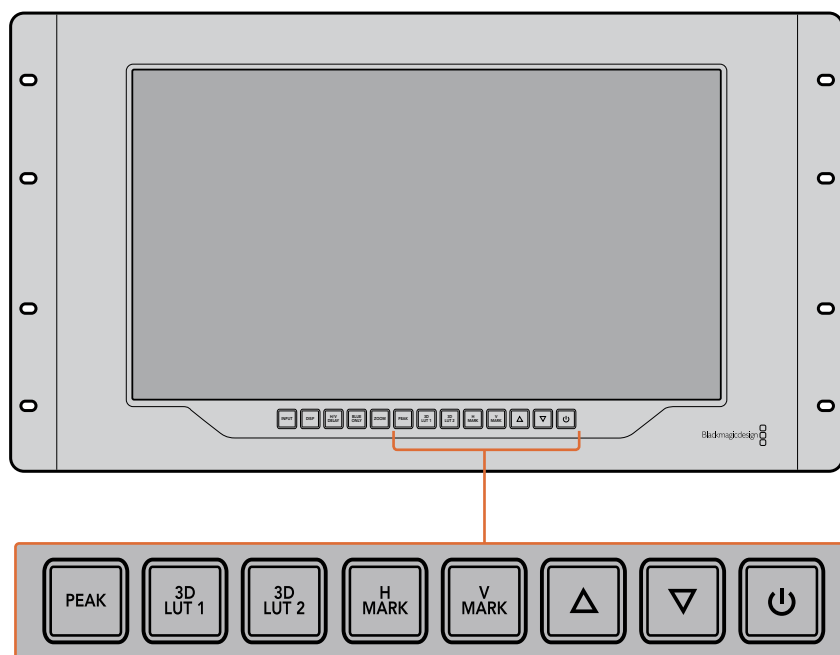

Up and Down Arrow Buttons

Use the up and down arrow buttons when editing a setting, for example adjusting the display brightness or editing frame marker positions.

Power

Press the power button once to turn your SmartView 4K on. Press again to turn off.

Loading 3D LUTs using Blackmagic SmartView Setup

SmartView 4K lets you monitor your video using 3D LUTs. This gives you the option to calibrate your SmartView 4K using professional calibration LUTs, or to view your video as close to your final grade as possible. You can also use 3D LUTs to experiment with different looks. LUTs are loaded into SmartView 4K using Blackmagic SmartView setup, and because SmartView 4K supports industry standard LUT files with a .cube file extension, you can even load custom LUTs generated with Blackmagic DaVinci Resolve. Refer to the DaVinci Resolve manual for more information about generating LUT files.

To load a 3D LUT into 3D LUT 1:

- 1 Launch Blackmagic SmartView setup.
- 2 Press the 'load LUT 1' load button. A window will open asking you for the location of the LUT file you want to load. Select the desired .cube LUT file, then press the 'open' button.
- 3 To view the LUT you just loaded, press the 3D LUT 1 button on the SmartView 4K control panel. Press the button again to turn the LUT off.

Follow the same procedure to load a LUT file into 3D LUT 2.

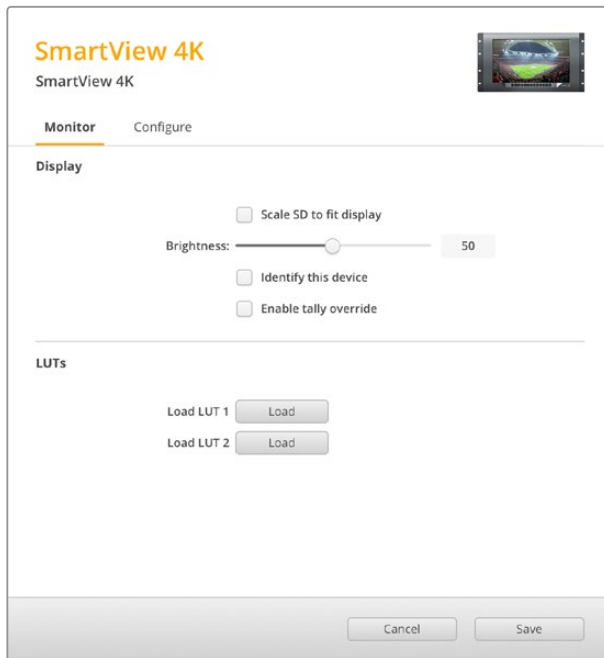

Use Blackmagic SmartView Setup to load 3D LUTs on your SmartView 4K

Using SmartScope Duo 4K

What is Blackmagic SmartScope?

Previously, broadcast quality television and post production scopes were incredibly expensive custom solutions that only let you see one scope at a time on a tiny screen! Some scopes look ugly and don't really look good in front of your client.

With SmartScope Duo 4K you get the addition of waveform monitors which allow you to see any aspect of your video signal on your dual monitors in real time. Any adjustments made to the input signal in Blackmagic SmartView setup can immediately be seen on SmartScope Duo 4K! Furthermore, each input signal can be sent to either monitor via the SDI loop out, meaning you can use the right hand monitor to display the scope for the signal going into the left hand monitor.

The scopes displayed by SmartScope Duo 4K are selected in the Blackmagic SmartView setup software. Select your scopes from the 'display' drop down menu.

The information below, and over the next several pages, explains how each scope display is used so you can get a deeper understanding of how each display can help you.



It's easy to set your Blackmagic SmartScope Duo 4K to show a different scope on each monitor using Blackmagic SmartView setup

Video Monitoring Display

The Video Monitoring display is a handy confidence monitor so you can see the video that is being received by SmartScope.

If your input signal is SD, you can select between displaying it in either 4:3 pillarbox or 16:9 from the 'set' drop down menu. Any changes made to the LCD brightness, contrast or saturation settings can be immediately seen in this view. Note that changing these settings only affects the monitor, not the video signal, so the scopes will not be affected by any saturation or brightness changes.

It can often be handy to set one monitor as 'video monitoring' and another as your scope view. To do this, use a short cable to connect the SDI loop out from 'monitor 1' to the SDI in of 'monitor 2'.

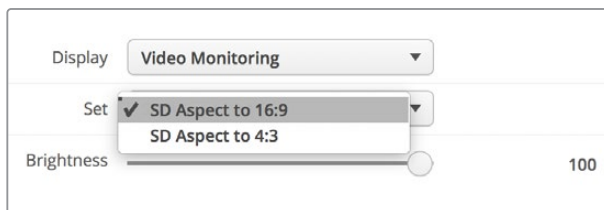

You can view SD video in 4:3 pillar box or 16:9 widescreen by selecting from the 'set' options in Blackmagic SmartView setup. Set 'SD aspect to 16:9' when viewing anamorphic standard definition video.

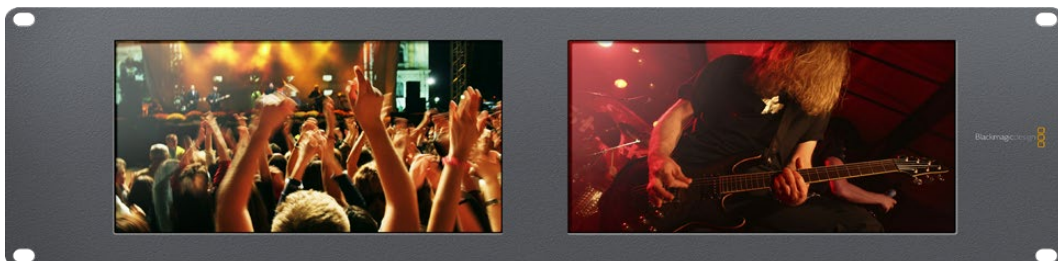

The video monitoring display setting shows the video signal as it will normally appear on a television screen or monitor

Waveform Display

The waveform display provides a digitally encoded waveform similar to traditional luminance waveform monitors, which is used to monitor and adjust the luma (brightness) levels of your video signal.

Traditional luminance waveform monitors only supported composite analog standard definition video. However, SmartScope Duo 4K's waveform view works in Ultra HD and HD as well as SD so you have a consistent and easy way to adjust luma levels, even when monitoring high definition digital video formats!

Select waveform from the display drop down menu in Blackmagic SmartView setup. You will want to make sure the blacks in your waveform do not drop below 0% and the whites do not exceed 100% as this means you are getting illegal luma values.

The waveform monitor is a graphical representation of the image, showing luma values in the same position relative to those within the frame. For example, if part of your sky is overexposed you will see it in the same horizontal position on the waveform display as it appears in the frame.

Depending on your footage, your waveform will look different. If you are monitoring video which is high contrast, you might not see any values in the mid grays. The picture below shows a waveform for an evenly exposed image with a dark patch on the left, and brighter values from the centre of the frame out to the right.

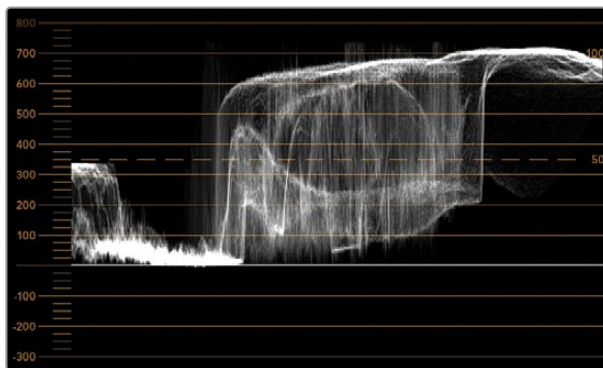

The waveform display showing luminance values

Adjust	<input checked="" type="radio"/> Left Monitor
	<input type="radio"/> Right Monitor
	<input type="radio"/> Both Monitors
Display	Waveform ▼
Set	No Options ▼

Select 'waveform' in Blackmagic SmartView setup 'display' settings to view the luminance values in your video signal

Vectorscope Display

The vectorscope display uses a vector view to show the colors in a video signal. Depending on the standard of color bar test signals used in your facility, select either 100% or 75% from the 'set' drop down menu in Blackmagic SmartView setup.

Some people think you can use a vectorscope to check for illegal levels, however this is not correct. The Parade RGB display should be used for checking for illegal colors. The reason you cannot use a vectorscope to check for illegal levels is that both chroma and luminance values are required. For example, colors near the white or black points in video cannot be as saturated as the much stronger colors, which can be used in the mid-grays. Because vectorscope display only shows colors, and not luminance values, it cannot be used solely to check for illegal colors.

Vectorscope display is the best tool for checking color levels from older, analog videotape where you need to adjust chroma levels. Just play back the color bar segment of the videotape, and then adjust the chroma and hue settings to set the colors of the video within the square boxes in the graticule.

Vectorscope display is also perfect for color grading, as you can easily see if your video is correctly white balanced or if there is a color tint. If your video has a color tint, the vectorscope display will drift off center, and you might see two center dots. Normally the blanking in the video signal will create a dot in the center of the vectorscope, and this is because the blanking in the video is black video without any color. Blanking provides a useful reference point to help recognize areas of black video without any color information.

If your video has a color tint, you should see the blacks move off color and off center. The degree of shift represents the amount of color tint in your video and you can see the shift in both the white and black details of your video. This makes vectorscope display valuable for removing color tint and regaining correct white balance.

Vectorscope display lets you push colors in your video to the limits, without accidentally adding unwanted color tints to blacks and whites. While color balance can be monitored on both the RGB parade display and vectorscope display, color balance issues will often be easier to see in the vectorscope display.

When color correcting footage of skin tone, particularly faces, you will want to keep your warm color saturation along a line at approximately 10 o'clock on the vectorscope. This is known as the "fleshtone line" and is based on the color of blood beneath the skin's surface. The fleshtone line is therefore applicable to all skin pigmentations and is the best way to ensure the skin tones of your talent look natural.

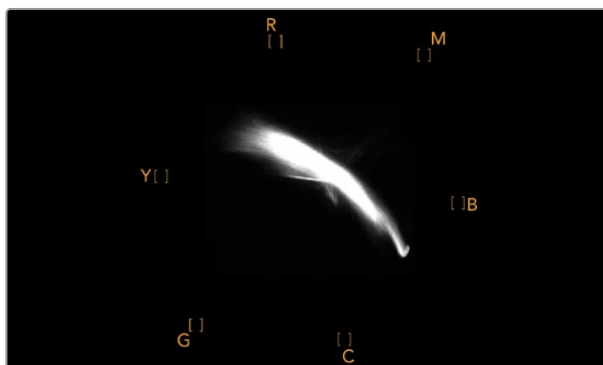

Vectorscope display showing the "fleshtone line" towards the 10 o'clock position

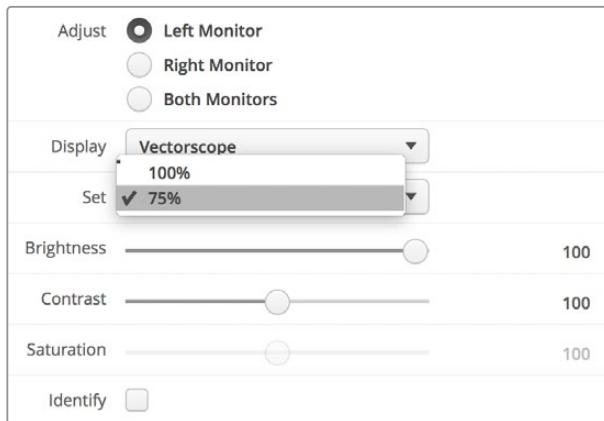

Set your vectorscope to 100% or 75% color bar test signals

Parade Display

RGB and YUV parade displays are perfect for color correction, checking for illegal colors and checking levels.

When color correcting, select RGB parade from the 'display' drop down menu in Blackmagic SmartView setup. RGB parade view displays the full height of the individual red, green and blue color channels. Monitoring the levels of each color channel makes color correction straightforward and it is also easy to view color balance in the blacks, mids and whites of the video signal. RGB parade display enables you to identify details common to the red, green and blue channels, making it simple to color balance and remove unwanted color tints.

It's important when color correcting to make sure the video levels are full but not clipped. If you want to increase the video level, make sure it doesn't go above upper RGB limit or you will encounter illegal levels. Some equipment won't let you generate illegal 100% RGB levels, however other equipment will. SmartScope Duo 4K lets you see illegal levels whenever they occur.

Illegal video can also happen in the black and white levels. In some color correction systems, black levels can be lowered to below the black point of 0%. If you observe illegal black levels, just add some "lift" or gain to eliminate them but check the 100% graticule level to make sure the whole video signal has not lifted and generated illegal colors in the whites.

To check YUV levels, select YUV parade from the 'display' drop down menu. This view is useful because the luma (brightness) values are separated from the chroma (color) values, which is the format of video signals for television broadcast. The left waveform shows the luma information and the second and third waveforms show the chroma information. YUV parade view is useful for calibrating a video signal's chroma values to a color bar test pattern, so that colors are represented accurately and the signal being broadcast will be displayable by television sets.

Color correcting is a constant adjustment process to attain the best looking images without generating illegal levels!

Color Correction Terminology

Blacks – Black levels in the video signal

Mids – Mid-gray levels in the video signal

Whites – White levels in the video signal

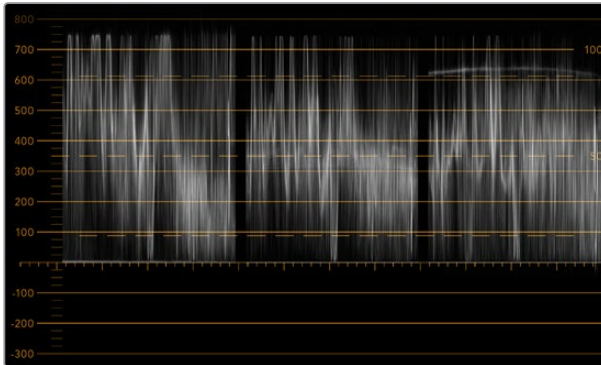

RGB parade view

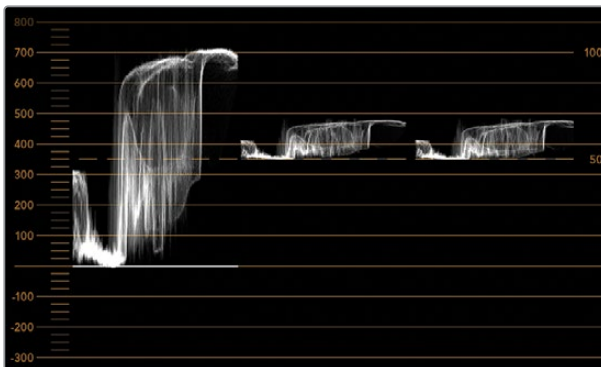

YUV parade view

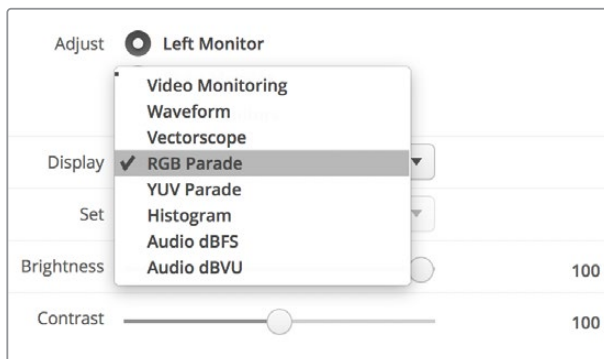

Select between RGB parade and YUV parade from the 'display' drop down menu in Blackmagic SmartView Setup

Histogram Display

Histogram display is most familiar to graphic designers and camera operators. Histogram display shows the distribution of white to black information and lets you monitor how close the detail is to being clipped off in the whites or blacks of the video. Histogram display also lets you see the effects of gamma changes in the video.

Black video is shown on the left of the display, and whites are shown on the right. All video should usually be found between the 0% and 100% intervals of the histogram display. Your video is being clipped if it moves below 0% or above 100%. Video clipping can be really bad when you're on a shoot, as detail in the blacks and whites must be preserved if you subsequently want to perform color-correction in a controlled environment. When shooting, keep the video above the black clip, and below the white clip, so you can have more freedom later to adjust colors without whites and blacks appearing flat and lacking in detail.

When color-correcting, you might decide to clip your video, and in which case histogram display will show the effect of clipping the video, and how much it is being clipped. You can even use gamma to create a similar look, with less clipping, while retaining more detail.

You cannot really use histogram display to check for illegal levels although you can use it to see illegal blacks and whites. Histogram display does not show colors and so the histogram might appear to show legal levels, even though your video may contain illegal colors. Again, RGB parade display provides the best way to watch out for illegal levels as it shows them in both the color and luminance elements of the video signal.

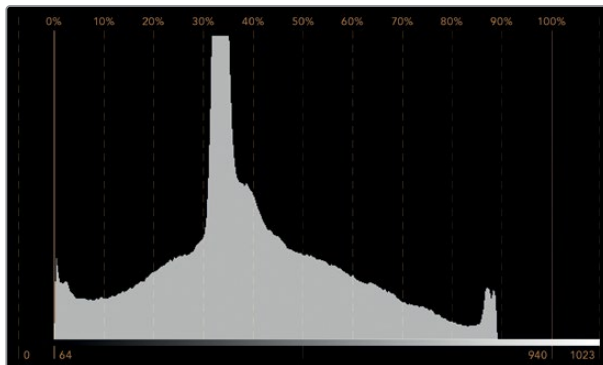

The histogram display setting showing distribution of whites to blacks

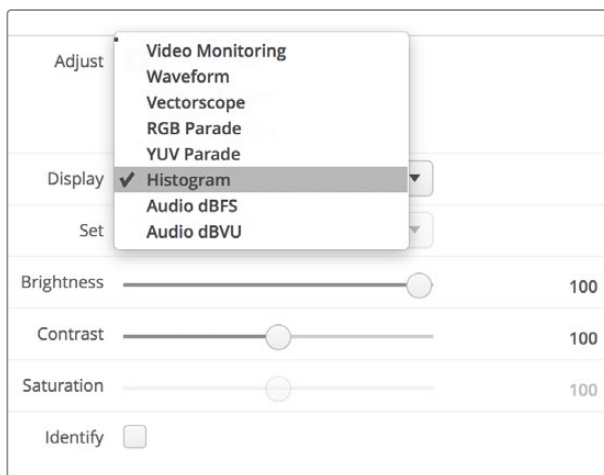

Select histogram from the 'display' drop down menu in Blackmagic SmartView setup

Audio Metering Display

The audio metering displays show you the audio levels in the embedded audio of the SDI video signal. Up to 16 channels of embedded audio are de-embedded and then displayed in either dBVU or dBFS format.

The VU meter shows average signal levels, is easy to use and very common on older equipment. VU is calibrated to the SMPTE recommendation of a 1 kHz tone test signal set to -20 dBFS.

dBFS is essentially a meter of the overall digital audio signal and is common on modern digital equipment.

The right hand audio scope can monitor two channels of audio, which can be selected from the 'set' drop down menu. e.g., ch 1 & 2, ch 3 & 4, etc. The audio scope presents audio in an X-Y view so you can see audio balance issues, out of phase conditions and whether an audio track is mono or stereo. Mono audio should appear as a single vertical "in phase" line. If the line is horizontal, then your audio is "out of phase" and could cancel out (i.e., loss of audio) when received by downstream equipment. Audio phase is one of the most common audio faults in large facilities, where cables can be incorrectly connected.

When monitoring stereo signals, the line of the right hand audio scope fans out to represent the difference between the left and right audio channels. The more stereo sound contained in the audio track, the more circular the line will appear. If the audio contains minimal stereo content, then the scope will appear more concentrated around the vertical axis.

Dialog audio tends to appear as a vertical line, whereas music with plenty of stereo content will cause the scope to puff out. This is because mono audio is L+R, and will display on the vertical axis, whereas stereo content is L-R, and will display on the horizontal axis to show the stereo difference.

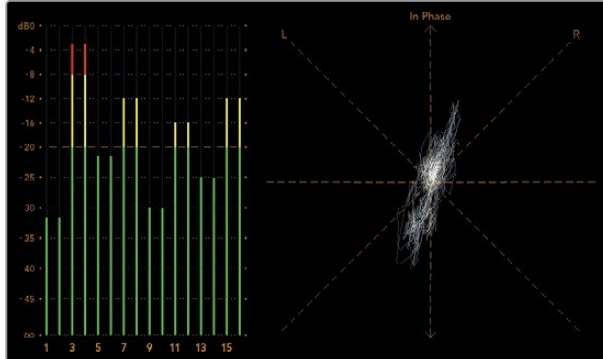

Audio metering display showing peak levels and audio balance

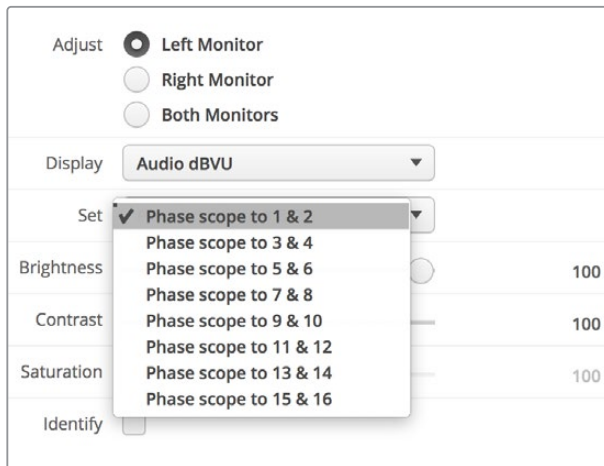

Use the “Set” drop down menu to select which pair of audio channels to monitor.

Connecting to a Network

By connecting a SmartView or SmartScope monitor to a network, you can adjust monitor settings for multiple units remotely.

While SmartView and SmartScope monitors display video without needing any configuration, any network settings need to be configured prior to deployment. Network configuration can only be performed using a direct USB connection to a computer.

Direct Ethernet

Remote monitor configuration can be performed via a direct Ethernet connection to your computer. No network switch is required in this configuration, which is great if you need to install and set up quickly. Additional units can be daisy-chained together using the active loop-through Ethernet out port on each unit. Power must be supplied to all units in the chain.

If you want to connect several units without using IP addresses from your existing studio network, or if you don't have an existing network, simply connect them directly to the Ethernet port on your computer. This is also a fast way to connect SmartView and SmartScope units via Ethernet as you don't need to run any cables back to a network switch.

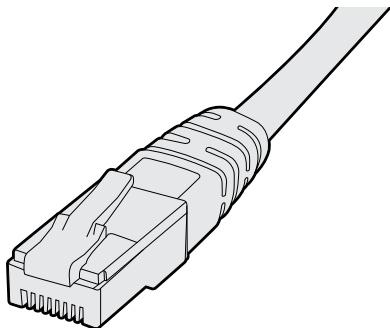

Ethernet Connector

Ethernet Network Switch

If you want to connect several units to your studio's network, you only need to connect one SmartView or SmartScope to the network switch and the rest can be daisy-chained to each other using the active loop-through Ethernet out port on each unit so only a single port on your switch is used. This way you won't have to run multiple cables back to a network switch. Power must be supplied to all units for daisy-chaining to work.

Connecting to a network switch allows any computer on the network to change a unit's settings. Any Mac or Windows laptop computer can also change settings via a WiFi connection if your network includes a wireless access point.

You will need to carry out the following steps to connect SmartView or SmartScope to a local area IP based network.

- 1 Securely connect and switch on the power supply included with your unit.
- 2 Connect the unit to a network switch, or directly to a computer, with a standard RJ45 Ethernet cable.

Direct Ethernet Connection Diagram

You can connect the Ethernet port of a computer directly to a unit without needing a network switch. Additional units can be daisy-chained to each other so you don't have to run multiple cables back to a network switch. Power must be supplied to all units.

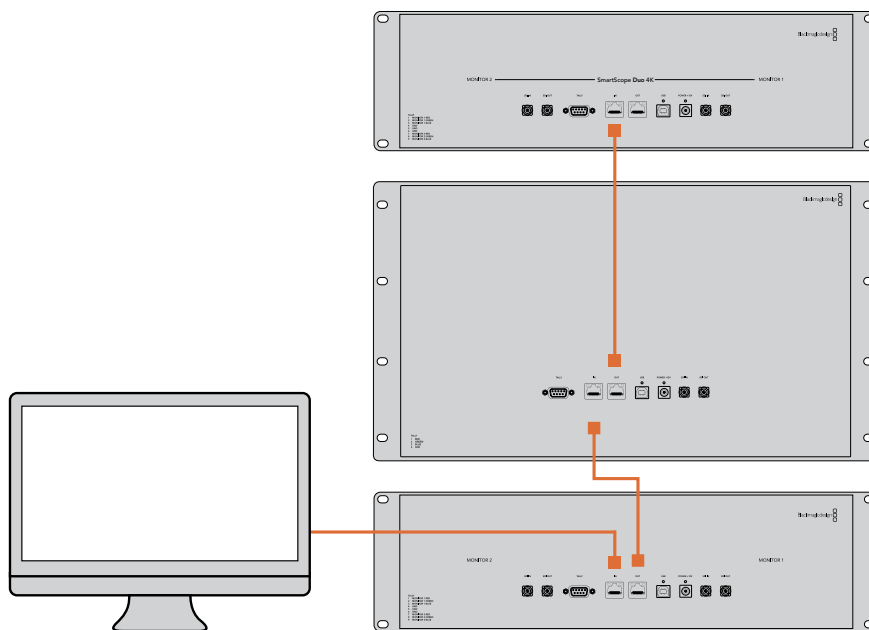

Ethernet Network Switch Connection Diagram

If you want to connect several units to your studio's existing network, you only need to connect one unit to the network switch. The rest can be daisy-chained to each other so you don't have to run multiple cables back to a network switch. Power must be supplied to all units.

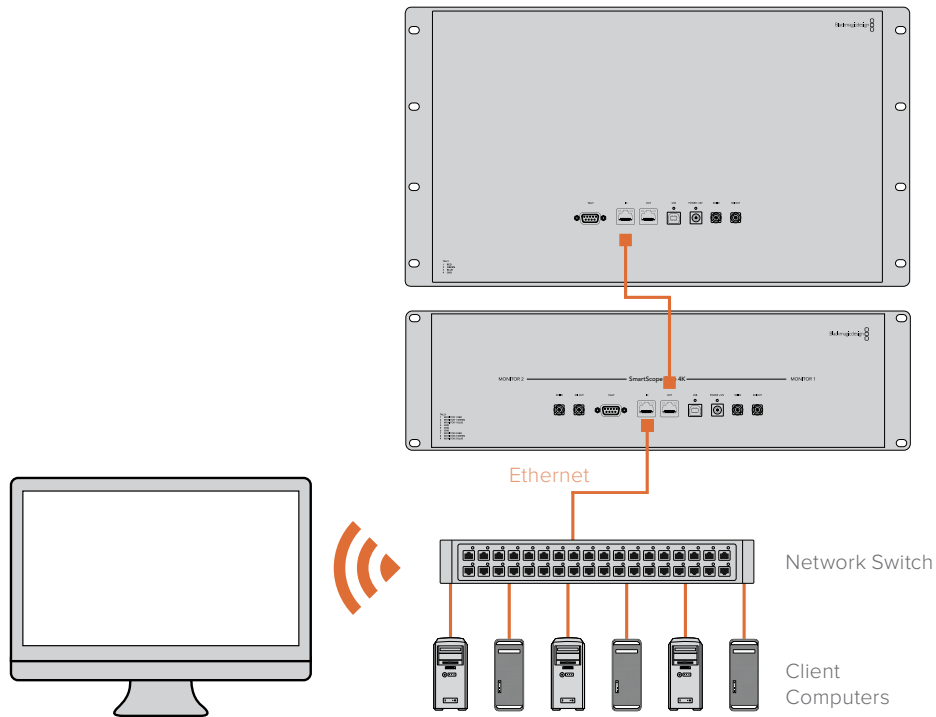

Adjusting Network Settings

Network Settings

Device Name

It is a good idea to change your monitor's name so each SmartView or SmartScope unit is easy to identify on a network, e.g., "Field Cameras 1 & 2", "Multi-View Output", "4K feeds" etc.

To change your monitor's name, make sure your monitor is connected via Ethernet or USB. Launch Blackmagic SmartView setup and click on the settings icon under your monitor name. In the setting page, click network, and edit the name of your monitor located in the 'details' section. If the software detects an invalid name, a warning icon will appear next to the name as you are typing. If the name is valid, a green tick will appear. Press the 'return' key on your computer keyboard to confirm the name change.

Network Settings

To make changes to the network settings section in Blackmagic SmartView setup, your Blackmagic monitor must be connected to the computer via USB. Network settings cannot be changed via Ethernet.

By default, SmartView and SmartScope use DHCP to automatically obtain an IP address from your network.

In the absence of a DHCP server, you may wish to enable the “internet sharing” feature of macOS, or the “internet connection sharing” (ICS) feature of Windows 8.1 or Windows 10, to provide DHCP addresses to any directly attached units. This will avoid having to manually assign static IP addresses to each unit. You can use this feature to provide DHCP addresses even though your computer might not have an Internet connection. Internet sharing is detailed in the macOS and Windows 8.1 and 10 Help documentation.

If DHCP cannot be used in your configuration, choose to configure the address using “static IP”. Please ask your system administrator for a spare IP address to avoid creating an IP conflict on your network. You will need to specify a unique IP address for each SmartView and SmartScope unit as well as a common subnet mask. It is unnecessary to change the default value in the “gateway” field unless you intend to connect your units to a network gateway such as an Internet router.

If no SmartView or SmartScope monitors are found on the network, the units might not have received IP addresses via DHCP and it will be necessary to manually configure each unit with appropriate network settings.

- 1 Connect a Blackmagic SmartView or SmartScope monitor to your computer via USB and launch Blackmagic SmartView setup.
- 2 Your connected monitor will be automatically displayed in the SmartView setup home page and will show a USB icon next to its name.
- 3 Adjust your monitor’s network settings.
- 4 Repeat these steps for any other units that have not received an IP address via DHCP.

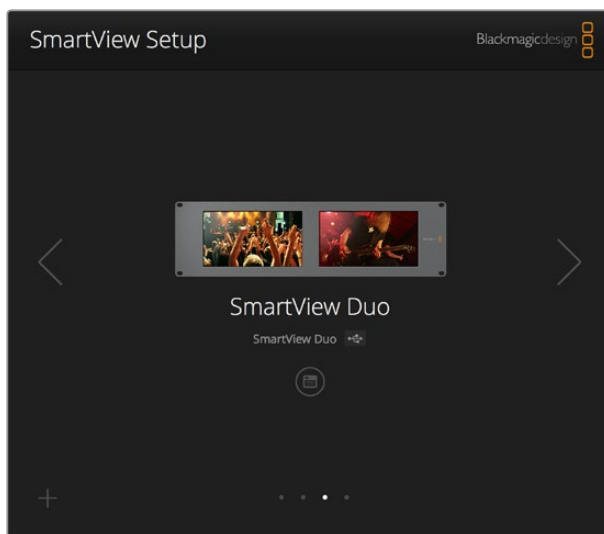

The USB icon next to your monitor’s name shows that the monitor is connected to your computer via USB. Your Blackmagic monitor needs to be connected via USB to adjust network settings.

The screenshot shows a 'Monitor Configure' window with the following details:

- Details:**
 - Name: SmartView Duo
 - Software Version: 4.0.1
- Network Settings:**
 - IP setting: DHCP, Static IP
 - IP Address: 192.168.10.42 (with a green checkmark icon)
 - Subnet Mask: 255.255.255.0
 - Gateway: 192.168.10.1

At the bottom of the window are 'Cancel' and 'Save' buttons.

Network settings can be set to use DHCP or a Static IP address and can only be changed via USB

Adding a Blackmagic Monitor

If you already know the IP address of a SmartView or SmartScope Duo 4K but it hasn't automatically appeared in the Blackmagic SmartView setup home page, you can add the monitor manually. To do so:

- 1 Make sure your Blackmagic monitor is connected via Ethernet. Click on the 'plus' icon at the bottom left corner to open the 'add a Blackmagic monitor' window.
- 2 Type in the IP address of the monitor and click 'add'.
- 3 The software will verify the presence of the unit and add it to the Blackmagic monitors included on the SmartView setup home page. Click the right arrow icon to see your newly added monitor.

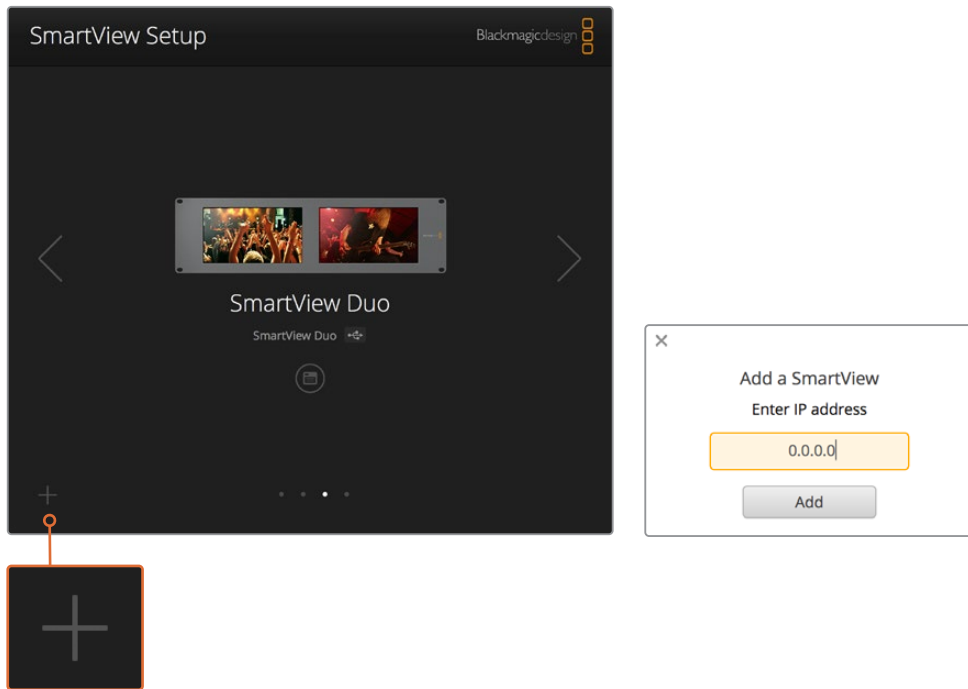

You can manually add a SmartView or SmartScope monitor to the list of connected monitors by clicking the 'plus' icon and entering the monitor's IP address

Using Tally

Tally Port Pin Connections

It is not necessary to connect the tally port of SmartView or SmartScope and you can skip this section if you do not intend to use the tally feature.

Each SmartView and SmartScope screen features independent tally borders in red, green or blue which can be used to indicate the status of a video signal such as on-air, preview or recording.

The 9-pin D-sub tally port accepts contact closure signals from switchers and automation systems. Please refer to the accompanying tally pin connections diagram for information about wiring the tally port for use with your switcher or automation system.

The 9-pin D port wiring description is printed on the rear of the unit showing contact closures to display red, green or blue tally borders on each independent monitor.

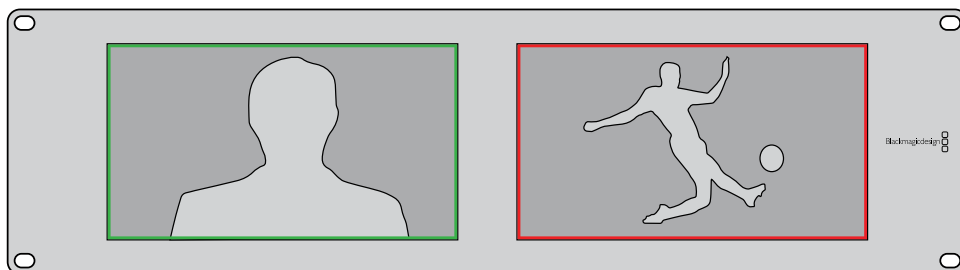

SmartView Duo showing green and red tally borders

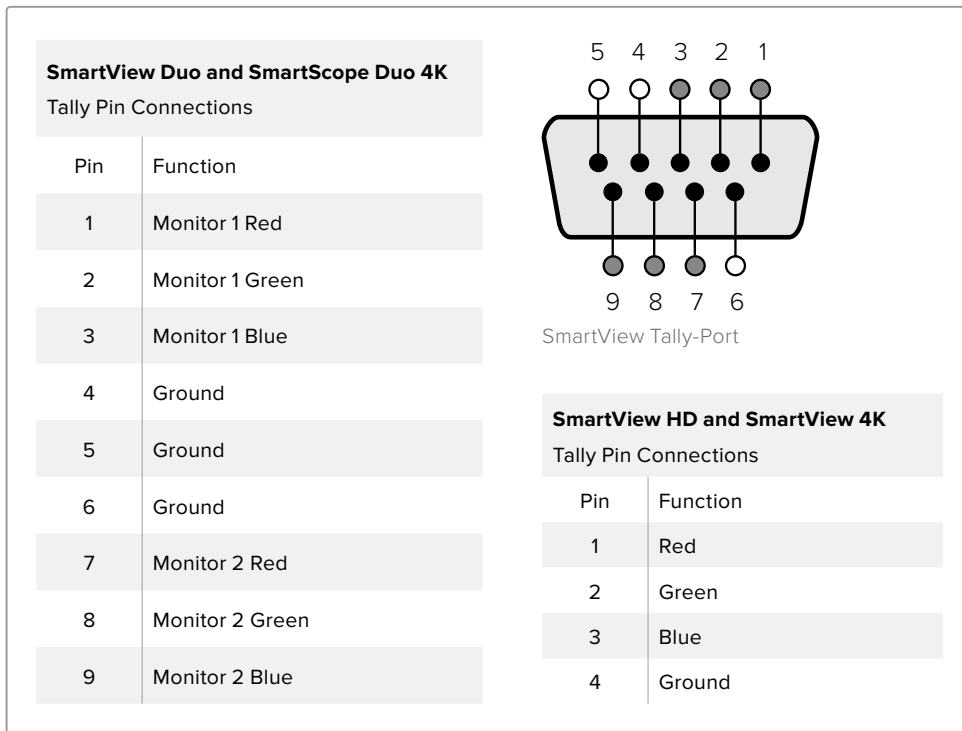

Optimizing the Viewing Angle

If SmartView Duo, SmartView HD or SmartScope monitors are to be installed high up in an equipment rack, you may wish to physically invert the LCDs for the optimum viewing angle. The images on the LCDs will automatically flip to the correct orientation when they sense an inversion. A number 02 size pozidriv screwdriver is required to disconnect and reconnect the faceplate from its rear assembly. This is a simple procedure and does not involve opening the rear assembly.

The following procedure describes how to invert the unit while keeping the Blackmagic Design logo in the correct orientation on the faceplate. A number 02 size pozidriv screwdriver is required.

- 1 Remove the screws from the top, bottom, left and right sides of the faceplate. SmartView Duo and SmartScope Duo 4K have 10 screws and SmartView HD has 18 screws.
- 2 Lift the front faceplate away from the rear assembly as illustrated.
- 3 Invert the rear assembly.
- 4 Reinstall the faceplate on the inverted rear assembly.
- 5 Reinstall the screws in the chassis.

Your SmartView or SmartScope is now ready to be installed high up in a rack. Once bolted into a rack, SmartView will continue to display the optimum viewing angle even if bumped, as there are no external knobs or adjustments to mishandle or to come loose.



You may wish to perform a test inversion, to check the optimum viewing angle, before bolting your unit high up in a rack

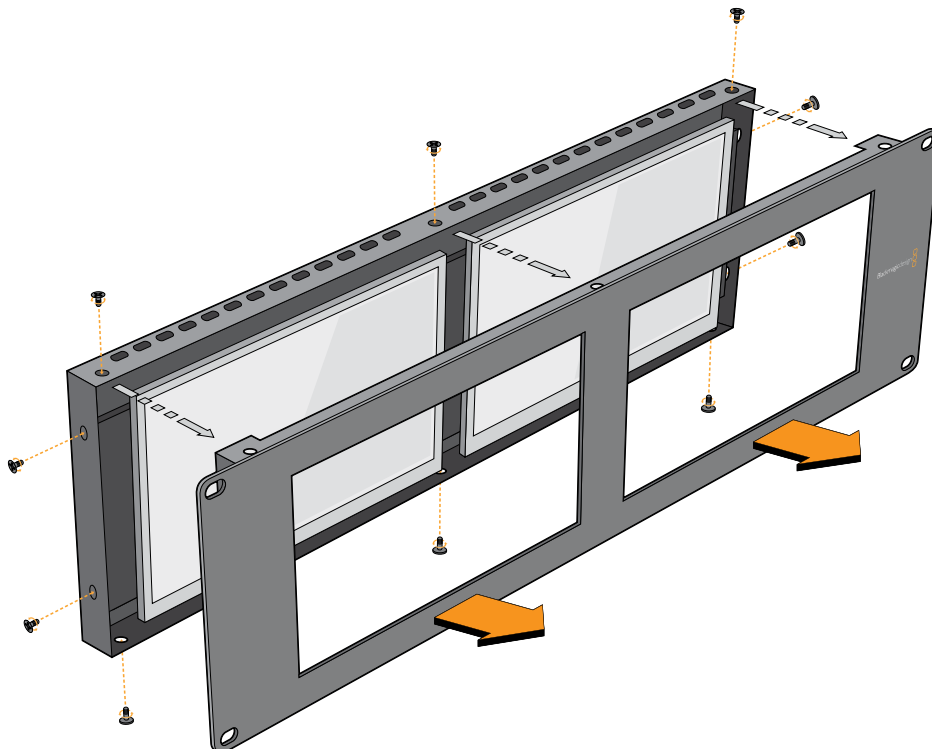

Remove all the screws to lift the front faceplate away from the rear assembly

Developer Information

Developing Custom Software Using Blackmagic Design Hardware

The Blackmagic SmartView Ethernet Protocol allows developers to remotely control Blackmagic SmartView and SmartScope hardware with their own custom software. The Blackmagic SmartView Ethernet Protocol is a text-based status and control protocol.

Downloading the Free SmartView Ethernet Protocol

The Blackmagic SmartView Ethernet Protocol is free. It is included in this SmartView & SmartScope manual and can be downloaded from www.blackmagicdesign.com/support

Joining the Blackmagic Design Developer List

The Blackmagic Developer mailing list is designed for technical questions regarding technologies used by Blackmagic Design, e.g., QuickTime, Core Media, DirectShow, codecs, APIs, SDKs, etc. The free mailing list is a forum where developers can discuss ideas and problems with other developers. Any subscriber may reply and the Blackmagic Design engineers may also respond when appropriate. You can subscribe to the mailing list at: <http://lists.blackmagicdesign.com/mailman/listinfo/bmd-developer>

In some cases, we might request a brief outline of the software you are developing if it is not immediately obvious from your domain name that your organization develops video software. Please don't take offence as we're simply trying to keep the list free of spam and viruses as well as end-user customers asking non-development questions, employment agents or sales people trying to promote products on the list. The list is just for developers.

Contacting Blackmagic Design Developer Assistance

You can also contact us via developer@blackmagicdesign.com if you have any developer related questions or wish to ask questions off the list.



Blackmagic 2K Format – Overview

Blackmagic Design products support 3G-SDI video, which allows twice the data rate of traditional HD-SDI video. We thought it would be a really nice idea to add 2K film support, via 3G-SDI technology, so we could simplify feature film workflows. With the popularity of Blackmagic Design editing systems worldwide, now thousands of people can benefit from a feature film workflow revolution.

This information includes everything product developers need to know for building native 2K SDI equipment. Of course, all Blackmagic products can be updated, so if the television industry adopts an alternative SDI-based film standard, we can add support for that too!

Frame Structure

- Transmitted at 23.98, 24 or 25 frames per second as a Progressive Segmented Frame.
- Active video is 2048 pixels wide by 1556 lines deep.
- Total lines per frame : 1650
- Active words per line are 1535. One word consists of a 10-bit sample for each of the four data streams, i.e., a total of 40 bits. See the diagram named Blackmagic 2K Format - Data Stream Format.
- Total active lines : 1556
- Total words per line : 1875 for 23.98/24Hz and 1800 for 25Hz.
- Fields per frame : 2, 825 lines each
- Active lines located on lines 16-793 (field 1) and 841-1618 (field 2).

Transport Structure

- Based on SMPTE 372M Dual Link mapping and SMPTE 425M-B support for mapping SMPTE 372M into a single 3 Gb/s link.
- Timing reference signals, line number and line CRC insertion is the same as above.
- During active video, 10-bit Red, Green and Blue data is sent in the following sequence:
- Optional ancillary data is inserted into both virtual interfaces.
- At present, only audio data is included: as per standard HD audio insertion (SMPTE S299M) the audio data packets are carried on data stream two and audio control packets are carried on data stream one.
 - Data stream 1: Green_1, Green_2, Green_3, Green_5...Green_2047
 - Data stream 2: Blue_1, Blue_2, Green_4, Blue_5...Green_2048.
 - Data stream 3: Red_1, Blue_3, Blue_4, Red_5...Blue_2048.
 - Data stream 4: Red_2, Red_3, Red_4, Red_6...Red_2048.

Blackmagic 2K Format – Vertical Timing Reference

This diagram shows the vertical timing details with line numbers and Field, Vertical and Horizontal bits for the Timing Reference Signal codes.

		Field 1					Active					
F	1	0	0	0	0	0	0	0	0	0	0	0
V	1	1	1	1	1	1	0	0	0	0	1	1
LINE #	1650	1	2	...	14	15	16	...	792	793	...	825

		Field 2					Active					
F	0	1	1	1	1	1	1	1	1	1	1	1
V	1	1	1	1	1	1	0	0	0	0	1	1
LINE #	825	826	827	...	839	840	841	...	1617	1618	...	1650

Blackmagic 2K Format – Data Stream Format

This diagram shows the data stream formats around the optional ancillary data section of the horizontal line. Note that each active pixel takes up three samples.

Word# 25 PsF	Word# 23.98/24 PsF	Data Stream 4	Data Stream 3	Data Stream 2	Data Stream 1
1795	1870	R2042	R2041	B2041	G2041
1796	1871	R2043	B2043	B2042	G2042
1797	1872	R2044	B2044	G2044	G2043
1798	1873	R2046	R2045	B2045	G2045
1799	1874	R2047	B2047	B2046	G2046
1800	1875	R2048	B2048	G2048	G2047
1	1	EAV(3FFh)	EAV(3FFh)	EAV(3FFh)	EAV(3FFh)
2	2	EAV(000h)	EAV(000h)	EAV(000h)	EAV(000h)
3	3	EAV(000h)	EAV(000h)	EAV(000h)	EAV(000h)
4	4	EAV(XYZh)	EAV(XYZh)	EAV(XYZh)	EAV(XYZh)
5	5	LN0	LN0	LN0	LN0
6	6	LN1	LN1	LN1	LN1
7	7	CRC0	CRC0	CRC0	CRC0
8	8	CRC1	CRC1	CRC1	CRC1
9	9	200	040	ANC/Audio Data	ANC/Audio Data
...		
260	335	200	040		
261	336	SAV(3FFh)	SAV(3FFh)	SAV(3FFh)	SAV(3FFh)
262	337	SAV(000h)	SAV(000h)	SAV(000h)	SAV(000h)
263	338	SAV(000h)	SAV(000h)	SAV(000h)	SAV(000h)
264	339	SAV(XYZh)	SAV(XYZh)	SAV(XYZh)	SAV(XYZh)
265	340	R2	R1	B1	G1
266	341	R3	B3	B2	G2
267	342	R4	B4	G4	G3
268	343	R6	R5	B5	G5

Blackmagic SmartView Ethernet Protocol v1.3

Summary

The Blackmagic SmartView Ethernet Protocol is a text-based status and control protocol, very similar in structure to the Videohub protocol, that is accessed by connecting to TCP port 9992 on a SmartView or SmartScope device.

Upon connection, the SmartView or SmartScope device sends a complete dump of the state of the device. After the initial dump, state changes are sent asynchronously.

The device sends information in blocks which have an identifying header, followed by a colon. A block can span multiple lines and is terminated by a blank line.

To be resilient to future protocol changes, clients should ignore blocks they do not recognize, up to the trailing blank line. Within recognized blocks, clients should ignore lines they do not recognize.

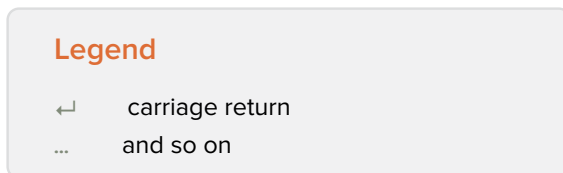

Version 1.3 of the Blackmagic SmartView Ethernet Protocol was released with SmartView 1.3 software.

Protocol Preamble

The first block sent by the SmartView Server is always the protocol preamble:

```
PROTOCOL PREAMBLE:↵
Version: 1.3 ↵
↵
```

The version field indicates the protocol version. When the protocol is changed in a compatible way, the minor version number will be updated. If incompatible changes are made, the major version number will be updated.

Device Information

The next block contains general information about the connected SmartView or SmartScope device.

```
SMARTVIEW DEVICE:↵
Model: SmartView Duo↵
Hostname: stagefront.studio.example.com↵
Name: StageFront↵
Monitors: 2↵
Inverted: false↵
↵
```

This example shows the output for a SmartView Duo device, which has two LCDs. The INVERTED flag indicates whether the device has detected that it has been mounted in an inverted configuration to optimize LCD viewing angle.

Network Configuration

The next block shows the TCP/IP networking configuration:

```
NETWORK:↵
Dynamic IP: true↵
Static address: 192.168.2.2↵
Static netmask: 255.255.255.0↵
Static gateway: 192.168.2.1↵
Current address: 192.168.1.101↵
Current netmask: 255.255.255.0↵
Current gateway: 192.168.1.1↵
↵
```

The network settings prefixed with CURRENT show the active TCP/IP settings, and are read-only. The CURRENT settings reflect either the DHCP or Static configuration, depending on the DYNAMIC IP flag.

Changing Networking Settings

The network can be configured to use either DHCP or a static configuration. To enable DHCP:

```
NETWORK:↵
Dynamic IP: true↵
↵
```

To set a fixed IP address, supply all static parameters, thus:

```
NETWORK:↵
Dynamic IP: false↵
Static address: 192.168.2.2↵
Static netmask: 255.255.255.0↵
Static gateway: 192.168.2.1↵
↵
```

The parameters with the CURRENT prefix are read-only, and show the active configuration, regardless of the static or dynamic setting.

Changing the device name, or any network settings, will cause the IP connection to be dropped. The device will restart its networking and advertise its new name on the network.

Changing Monitor Settings

The display settings for each monitor are specified individually. One or more parameters can be modified at the same time and multiple settings can be supplied in one block.

The valid range for numeric values is 0-255. The CONTRAST and SATURATION properties are zero-centered, so the normal value is 127, such that the displayed picture is the same as the original. A value greater than 127 in either channel will cause the contrast or saturation to be increased, and similarly a value less than 127 will cause a decrease.

For example, to set the brightness to 50% and desaturate the image to Black & White:

```
MONITOR A:↵
Brightness: 127↵
Saturation: 0↵
↵
```

Displaying SD in 16:9

The following command sets standard definition video to display in 16:9:

```
MONITOR A:↵  
WidescreenSD: ON↵
```

Displaying SD in 4:3

The following command sets standard definition video to display in 4:3:

```
MONITOR A:↵  
WidescreenSD: OFF↵
```

Identification and Tally Settings

The Identify flag is transient, and will cause a white border to be displayed around the entire picture for a duration of 15 seconds, after which it will be reset. This feature is primarily aimed at identifying which monitor is currently being configured when it is mounted in a rack comprising multiple units. To turn on:

```
MONITOR A:↵  
Identify: true↵  
↵
```

The IDENTIFY border will temporarily override any other border setting in effect.

The BORDER property can be used to programmatically set the soft Tally colored borders to one of the primary colors: RED, GREEN, BLUE, WHITE or NONE. This setting can be overridden by the electrical Tally signals at the DB-9 input on the device itself. For example, to set the soft Tally to green:

```
MONITOR B:↵  
Border: green↵  
↵
```

The hard wired tally will always override the soft tally. The full state report will always show the current valid border.

SmartScope Settings

On SmartScope Duo 4K, each monitor can be set to display a different scope. The values for activating specific scopes are mapped as follows:

- AudioDbfs
- AudioDbvu
- Histogram
- ParadeRGB
- ParadeYUV
- Picture (This is the same as Video Monitor)
- Vector100
- Vector75
- WaveformLuma

```
MONITOR A:↵  
ScopeMode: Picture↵  
↵
```

In the example above, Monitor A has been set as a video monitor.

Displaying SD in 16:9

The set Video Monitor mode to display standard definition video in 16:9:

```
MONITOR A:↵  
ScopeMode: Picture↵  
WidescreenSD: ON↵
```

Displaying SD in 4:3

To set Video Monitor mode to display standard definition video in 4:3:

```
MONITOR A:↵  
ScopeMode: Picture↵  
WidescreenSD: OFF↵
```

When setting one of SmartScope Duo 4K's monitors to audio metering, you can also select which channels to show. The values for selecting which audio channels are mapped in the following way:

- 0: Channels 1 and 2
- 1: Channels 3 and 4
- 2: Channels 5 and 6
- 3: Channels 7 and 8
- 4: Channels 9 and 10
- 5: Channels 11 and 12
- 6: Channels 13 and 14
- 7: Channels 15 and 16

```
MONITOR B:↵  
ScopeMode: AudioDbvu↵  
AudioChannel: 0↵
```

```
↵
```

In the example above, Monitor B has been selected to display Audio Metering in Dbvu with audio channels 1 and 2 selected for the phase meter.

Selecting LUTs for SmartView 4K

To select 3D LUTs using SmartView 4K:

```
MONITOR A:↵  
LUT: 0          LUT 1  
      1          LUT 2  
      NONE      DISABLE
```

```
↵
```

```
↵
```

Help

Getting Help

There are four Steps to Getting Help.

- 1** Check out the Blackmagic Design support center at www.blackmagicdesign.com/support for the latest support information.
- 2** Call your Blackmagic Design reseller.
- 3** Your local reseller will have the latest technical updates from Blackmagic Design and should be able to give you immediate assistance. We also recommend you check out the support options your reseller offers as they can arrange various support plans based on your workflow requirements.
- 4** The next option is to email us with your questions using the “send us an email” button at www.blackmagicdesign.com/support
- 5** Phone a Blackmagic Design support office. You can find your nearest office by clicking on the “find your local support team” button at the bottom of the support page.

Please provide us with as much information as possible regarding your technical problem and system specifications so that we may try to respond to your problem as quickly as possible.

Regulatory Notices

Disposal of Waste of Electrical and Electronic Equipment Within the European Union.



The symbol on the product indicates that this equipment must not be disposed of with other waste materials. In order to dispose of your waste equipment, it must be handed over to a designated collection point for recycling. The separate collection and recycling of your waste equipment at the time of disposal will help conserve natural resources and ensure that it is recycled in a manner that protects human health and the environment. For more information about where you can drop off your waste equipment for recycling, please contact your local city recycling office or the dealer from whom you purchased the product.



This equipment has been tested and found to comply with the limits for a Class A digital device, pursuant to Part 15 of the FCC rules. These limits are designed to provide reasonable protection against harmful interference when the equipment is operated in a commercial environment. This equipment generates, uses, and can radiate radio frequency energy and, if not installed and used in accordance with the instructions, may cause harmful interference to radio communications. Operation of this product in a residential area is likely to cause harmful interference, in which case the user will be required to correct the interference at personal expense.

Operation is subject to the following two conditions:

- 1 This device may not cause harmful interference.
- 2 This device must accept any interference received, including interference that may cause undesired operation.

—



MSIP-REM-BMD-201410001
MSIP-REM-BMD-20150327
MSIP-REM-BMD-201702004
MSIP-REM-BMD-201702005

ISED Canada Statement

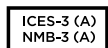

This device complies with Canadian standards for Class A digital apparatus.

Any modifications or use of this product outside its intended use could void compliance to these standards.

Connection to HDMI interfaces must be made with high quality shielded HDMI cables.

This equipment has been tested for compliance with the intended use in a commercial environment. If the equipment is used in a domestic environment, it may cause radio interference.

Safety Information

For protection against electric shock, the equipment must be connected to a mains socket outlet with a protective earth connection. In case of doubt contact a qualified electrician.

To reduce the risk of electric shock, do not expose this equipment to dripping or splashing.

Product is suitable for use in tropical locations with an ambient temperature of up to 40°C.

Ensure that adequate ventilation is provided around the product and that it is not restricted.

When rack mounting, ensure that the ventilation is not restricted by adjacent equipment.

No operator serviceable parts inside product. Refer servicing to your local Blackmagic Design service center.

Some products have the facility to connect small form-factor transceiver (SFP) optical fibre modules. Only use Laser class 1 optical SFP modules.

Recommended Blackmagic Design SFP modules:

- **3G-SDI:** PL-4F20-311C
- **6G-SDI:** PL-8F10-311C
- **12G-SDI:** PL-TG10-311C



Use only at altitudes not more than 2000m above sea level.

State of California statement

This product can expose you to chemicals such as trace amounts of polybrominated biphenyls within plastic parts, which is known to the state of California to cause cancer and birth defects or other reproductive harm.

For more information go to www.P65Warnings.ca.gov.

Warranty

12 Month Limited Warranty

Blackmagic Design warrants that this product will be free from defects in materials and workmanship for a period of 12 months from the date of purchase. If a product proves to be defective during this warranty period, Blackmagic Design, at its option, either will repair the defective product without charge for parts and labor, or will provide a replacement in exchange for the defective product.

In order to obtain service under this warranty, you the Customer, must notify Blackmagic Design of the defect before the expiration of the warranty period and make suitable arrangements for the performance of service. The Customer shall be responsible for packaging and shipping the defective product to a designated service center nominated by Blackmagic Design, with shipping charges pre paid. Customer shall be responsible for paying all shipping charges, insurance, duties, taxes, and any other charges for products returned to us for any reason.

This warranty shall not apply to any defect, failure or damage caused by improper use or improper or inadequate maintenance and care. Blackmagic Design shall not be obligated to furnish service under this warranty: a) to repair damage resulting from attempts by personnel other than Blackmagic Design representatives to install, repair or service the product, b) to repair damage resulting from improper use or connection to incompatible equipment, c) to repair any damage or malfunction caused by the use of non Blackmagic Design parts or supplies, or d) to service a product that has been modified or integrated with other products when the effect of such a modification or integration increases the time or difficulty of servicing the product. THIS WARRANTY IS GIVEN BY BLACKMAGIC DESIGN IN LIEU OF ANY OTHER WARRANTIES, EXPRESS OR IMPLIED. BLACKMAGIC DESIGN AND ITS VENDORS DISCLAIM ANY IMPLIED WARRANTIES OF MERCHANTABILITY OR FITNESS FOR A PARTICULAR PURPOSE. BLACKMAGIC DESIGN'S RESPONSIBILITY TO REPAIR OR REPLACE DEFECTIVE PRODUCTS IS THE WHOLE AND EXCLUSIVE REMEDY PROVIDED TO THE CUSTOMER FOR ANY INDIRECT, SPECIAL, INCIDENTAL OR CONSEQUENTIAL DAMAGES IRRESPECTIVE OF WHETHER BLACKMAGIC DESIGN OR THE VENDOR HAS ADVANCE NOTICE OF THE POSSIBILITY OF SUCH DAMAGES. BLACKMAGIC DESIGN IS NOT LIABLE FOR ANY ILLEGAL USE OF EQUIPMENT BY CUSTOMER. BLACKMAGIC IS NOT LIABLE FOR ANY DAMAGES RESULTING FROM USE OF THIS PRODUCT. USER OPERATES THIS PRODUCT AT OWN RISK.

© Copyright 2020 Blackmagic Design. All rights reserved. 'Blackmagic Design', 'DeckLink', 'HDLink', 'Workgroup Videohub', 'Multibrige Pro', 'Multibrige Extreme', 'Intensity' and 'Leading the creative video revolution' are registered trademarks in the US and other countries. All other company and product names may be trade marks of their respective companies with which they are associated.



インストール/オペレーション マニュアル

SmartView & SmartScope

2020年9月

日本語



ようこそ

最高品質のビデオを誰もが利用できるようにすることで、テレビ業界を真にクリエイティブな業界にするという私たちの夢をユーザーの皆様と共有できればと考えています。

放送局やスタジオでは、あらゆる場所でビデオモニタリングが必要になります。SmartView 4Kはネイティブ4KのLCDを搭載しているため、Ultra HDビデオをフル解像度でモニタリングでき、スタイリッシュな6Uラックサイズの筐体にはコントロールパネルが搭載されているため、すばやく設定が変更できます。SmartView HDは、奥行き1インチ未満の6Uラックサイズの筐体に17インチのLCDスクリーンを搭載しています。SmartView Duoは、奥行き1インチ未満の3Uラックサイズの筐体に、2面の完全に独立した機能的な8インチLCDスクリーンを搭載しています。SmartScope Duo 4Kは、波形スコープ機能に対応した2面の独立した8インチLCDスクリーンを搭載しているため、ビデオレベルをオンザフライでモニタリングできます。すべてのSmartViewモニターは、3G-SDIインターフェースを搭載し、SD、HD、2Kに対応しています。SmartScope Duo 4KおよびSmartView 4Kは、それぞれ6G-SDIまたは12G-SDIインターフェースを搭載し、Ultra HD 4Kに対応しています。

これらのモニターは、箱から取り出してすぐに使用できるよう設計されています。同梱のBlackmagic SmartView Setupソフトウェアは、直感的なコンフィギュレーション・ツールを搭載しています。

このマニュアルには、SmartView/SmartScopeのインストールに必要な情報がすべて記載されています。しかし、IPアドレスやコンピューターネットワークに関してあまり詳しくない場合は、技術的なアシストを専門家から得ることもお勧めします。SmartView/SmartScopeは簡単にインストールできますが、インストール後に少し技術的な環境設定が必要になることがあります。

インストールの所要時間は約5分です。弊社のウェブサイトwww.blackmagicdesign.com/jpのサポートページで、このマニュアルとSmartViewソフトウェアの最新バージョンをダウンロードしてください。最後に、ソフトウェア・アップデートをダウンロードする際に製品のユニットを登録いただければ、新しいソフトウェアのリリース時にお知らせいたします。常に新機能の開発および製品の改善に努めていますので、ユーザーの皆様からご意見をいただければ幸いです。

A handwritten signature in black ink that reads "Grant Petty". The signature is written in a cursive, flowing style.

グラント・ペティ

Blackmagic Design CEO

目次

SmartView & SmartScope

はじめに	45
SmartView、SmartScopeとは	45
ビデオソースを接続	46
コンピューターを接続	46
Blackmagic SmartView Setupのインストール	47
Blackmagic SmartView Setupの使用	48
ソフトウェア・アップデート	48
モニター設定の調整	48
タリーオーバーライドの有効化	51
SmartView 4Kの使用	51
Blackmagic SmartView 4Kについて	51
コントロールパネルボタン	52
Blackmagic SmartView Setupで3D LUTをロード	54
SmartScope Duo 4Kの使用	55
Blackmagic SmartScopeとは	55
ビデオモニタリング表示	56
波形表示	57
ベクトルスコープ表示	58
パレード表示	59
ヒストグラム表示	61
オーディオメーター表示	62
ネットワークに接続	63
ダイレクト・イーサネット	63
イーサネット・ネットワークスイッチ	64
ネットワーク設定の調整	65
ネットワーク設定	65
Blackmagicモニターの追加	67
タリーの使用	68
タリーポートのピン接続	68
ビューアングルの最適化	69
Developer Information	71
Blackmagic 2K Format – Overview	71
Blackmagic 2K Format – Vertical Timing Reference	72
Blackmagic 2K Format – Data Stream Format	73
Blackmagic SmartView Ethernet Protocol v1.3	74
ヘルプ	78
規制に関する警告	79
安全情報	80
保証	81

はじめに

SmartView、SmartScopeとは

SmartViewモニターは、ラックベースのモニタリングを必要とする、あらゆるスタジオに最適です。電源を入れてSDIソースを接続するだけで、起動/操作が可能になります。

SmartView 4Kは、15.6インチの4K LCDを搭載しているため、SD、HD、Ultra HDビデオをネイティブ 3840x2160解像度でモニタリングできます。フロントコントロールパネルのボタンで、入力の選択、画面の明るさの調整、ブルーチャンネルのノイズチェック、ブランキング情報の確認、3D LUTの適用などが簡単に実行できます。

SmartView HDは、17インチのLCDスクリーンを搭載しており、フル解像度HDのモニタリングが可能です。

SmartView Duoは、2面のモニターを搭載しており、異なるビデオ信号を同時に表示できます。例えば、1面のモニターでYUV 4:2:2信号を表示し、もう1面でRGB 4:4:4を表示したり、片方でNTSCを表示し、もう一方でPALを表示することもできます。このように様々なコンビネーションの信号を表示できますが、操作自体は、SDIケーブルを各モニターに接続するだけなので非常に簡単です。

SmartScope Duo 4Kは、SmartScope Duoと同じ機能を搭載しています。それに加え、波形やベクトルスコープなどのスコープを使用してビデオやオーディオレベルをリアルタイムでモニタリングできます。また、Ultra HD 4Kもフルサポートしています！

SmartView/SmartScopeモニターのすべてのSDI入力は、2Kビデオを含め、SD、HD、3G-SDIの自動検出に対応しています。SmartView 4Kは、12G-SDIインターフェースを搭載し、2160p60などのUltra HDフォーマットも検出します。SmartScope Duo 4Kは、6G-SDIインターフェースを搭載し、Ultra HD 4Kビデオを自動検出します。

複数のSmartView/SmartScopeの設定を1台のコンピューターからリモート調整したい場合は、イーサネットを介して接続できます。つまり、設定を調整する際も、コンピューターやUSBケーブルを手にも各ユニット間を走り回る必要はありません。

では実際に製品を使用してみましょう。SmartView/SmartScopeの接続、Blackmagic SmartView Setupでのモニター設定、およびネットワークへの接続に関する詳細は、このマニュアルに後述されています。



SmartView 4K



SmartView HD



SmartView Duo



SmartScope Duo 4K

ビデオソースを接続

SmartView/SmartScopeモニターは、標準のBNC端子を搭載しており、スイッチャー、カメラ、キャプチャーカード、デッキ、ディスクレコーダーなど、あらゆるSDI機器を接続できます。

映像の受信

ビデオの表示は非常に簡単です。ユニットの電源を入れてビデオソースをSDI入力に接続するだけで、すぐにビデオが画面に表示されます。SDI入力およびループスルー出力は、SD、HD、2K信号を自動検出します。SmartView 4KおよびSmartScope Duo 4Kは、Ultra HD 4Kも自動検出します。

ユニットが映像を受信していない場合、節電のためバックライトが消えますが、有効な信号を受信すると再び点灯します。

モニターをデジーチェーンで接続

SmartView/SmartScopeモニターは、それぞれ独立したSDI入力とループスルー出力を搭載しているため、複数のモニターをチェーン接続して同じ入力信号を表示できます。

- 1 ユニット1の電源を入れます。ビデオソースをSDI入力に接続します。ビデオが即座にスクリーンに表示されます。
- 2 ユニット2の電源を入れ、ユニット1のループスルー出力のSDIケーブルを、ユニット2のSDI入力に接続します。

この方法で、ユニット数に制限なくチェーン接続できます。

SmartScope Duo 4Kで波形モニタリングしている場合、モニター1の出力をモニター2にループすると、両方のスクリーンで同じ入力信号をモニタリングできます。

映像が表示されたら、モニター設定を調整します。あるいは、SmartScope Duo 4Kでは、Blackmagic SmartView Setupソフトウェアを使ってスコープを選択します。同ソフトウェアでは3D LUTをBlackmagic SmartView 4Kにロードすることもできます。



SmartView 4K



SmartView HD



SmartView Duo



SmartScope Duo 4K

コンピューターを接続

USBでコンピューターに接続し、Blackmagic SmartView SetupをインストールすることでSmartViewまたはSmartScopeのモニター設定が可能になります。

また、USB接続でBlackmagic Designウェブサイトからダウンロードしたソフトウェアアップデートを適用することもできます。ソフトウェアアップデートでは、新機能、新しいハードウェアとの互換性、新しいフォーマットのサポートなどを提供しています。Blackmagic SmartView Setupソフトウェアは、macOSまたはWindowsで使用できます。

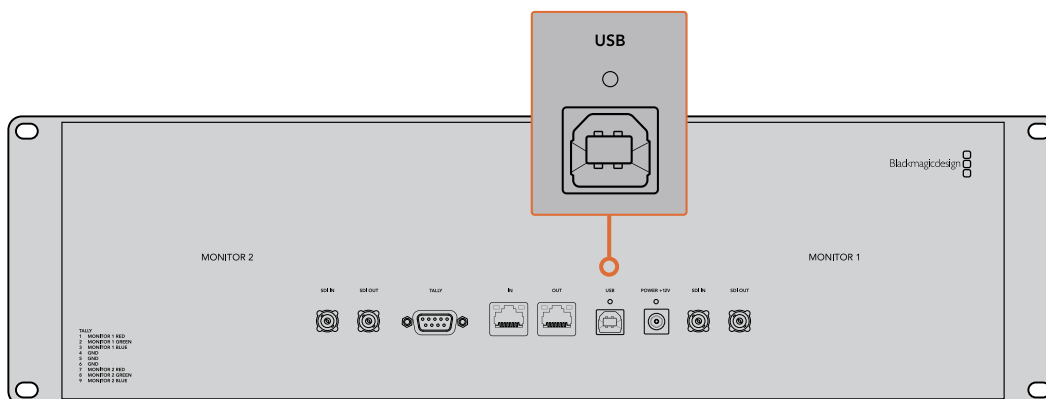

Blackmagic SmartView Setupのインストール

Blackmagic SmartView Setupは、macOSの最新のSierraおよびHigh Sierraバージョン、または最新のサービスパックがインストールされた64-bitバージョンのWindows 8.1および10で起動します。Blackmagic SmartView Setupは、必要に応じてネットワーク上の複数のコンピューターにインストールすることもできます。

SmartViewに同梱のSDカードにはソフトウェアインストーラーが含まれていますが、Blackmagicサポートセンター (www.blackmagicdesign.com/jp/support) で最新のアップデートをチェックすることをお勧めします。

macOSへのインストール:

同梱のSDカードを起動するか、ダウンロードしたディスクイメージから「Install SmartView」アイコンをダブルクリックしてインストーラーを開きます。SmartViewフォルダーが作成され、その中にSmartView Setup、以前のバージョンからアップデートする際に使用するアンインストーラー、このマニュアルやその他の情報を含むドキュメントフォルダーが含まれています。

Windowsへのインストール:

同梱のSDカードを起動するか、ダウンロードしたzipファイルを開き、「Install SmartView」アイコンをダブルクリックしてインストーラーを開きます。画面に表示されるメッセージに従い、ソフトウェアをインストールします。

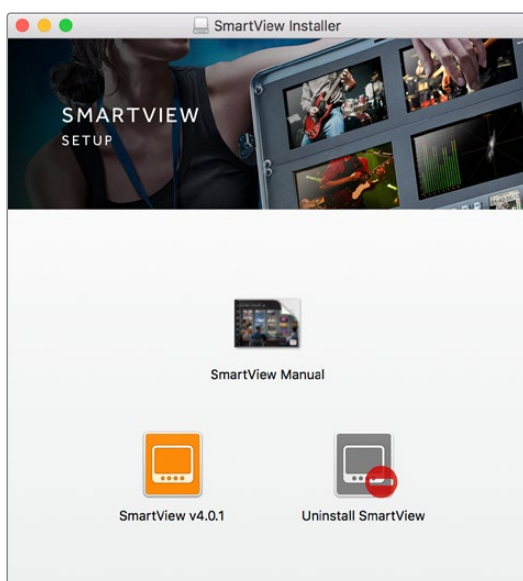

macOSへのインストールは、同梱のSDカードまたはダウンロードしたフォルダーからSmartView.dmgを起動し、その後「Install SmartView」アイコンをダブルクリックします。

Blackmagic SmartView Setupの使用

ソフトウェア・アップデート

Blackmagic SmartView Setupをインストールして起動し、モニター名の下の設定アイコンをクリックします。SmartView/SmartScopeの内部ソフトウェアをアップデートするようにメッセージが表示される場合があります。ソフトウェアのアップデート：

- 1 USBまたはイーサネット経由で、コンピューターとSmartView/SmartScopeを接続し、Blackmagic SmartView Setupソフトウェアを起動します。
- 2 メッセージが表示されたら「Update」をクリックします。アップデートの所要時間は約5分です。
- 3 アップデートが完了すると「This SmartView has been updated (このSmartViewはアップデートされました)」というメッセージが表示されます。
- 4 「Close」をクリックします。

内部ソフトウェアのアップデートが不要な場合、Blackmagic SmartView Setupのモニターの設定ページが開きます。

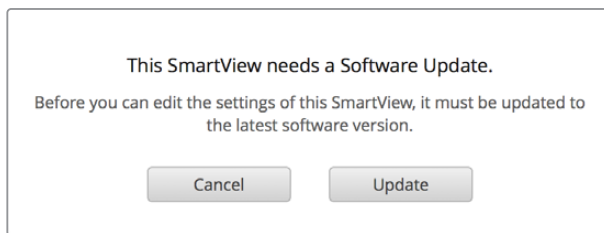

Blackmagic SmartView Setupを起動し、接続したSmartView/SmartScopeの設定アイコンをクリックすると、内部ソフトウェアのアップデートが必要な場合、このメッセージが表示されます。

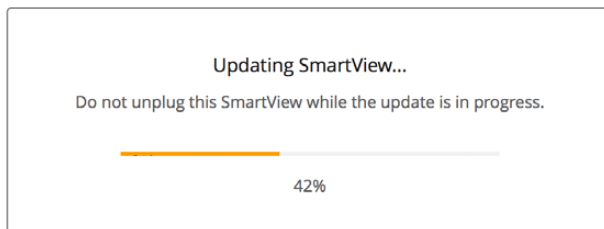

アップデートの所要時間は約5分です。

モニター設定の調整

Blackmagic SmartView Setupを起動すると、すぐにUSBまたはイーサネット経由で接続されているSmartView/SmartScopeを探し、SmartView Setupのホームページに表示します。ネットワークに複数のBlackmagicモニターを接続している場合、ホームページの両側にある左右の矢印をクリックして調整を行うモニターを選択します。BlackmagicモニターがUSBで接続されている場合、モニター名の横にUSBアイコンが表示されます。

設定を調整するには、USBまたはイーサネット経由で接続されているモニターを選択し、モニター名の下
の設定アイコンをクリックします。これにより、選択したモニターの設定ページが開きます。設定が終
わったら「Save」ボタンを押して保存し、SmartView Setupのホームページに戻ります。

Blackmagicモニターの設定と適用方法に関しては、次のセクションを参照してください。Blackmagic
SmartView Setupでのネットワーク設定のコンフィギュレーション方法は「ネットワーク設定の調整」セク
ションを参照してください。

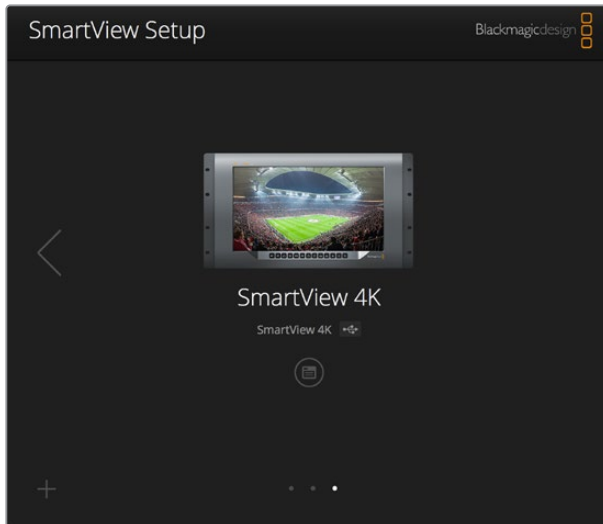

Blackmagic SmartView Setupは自動的にUSBまたはネットワー
クに接続されているSmartView/SmartScopeを検出。モニター
の内部ソフトウェアをアップデートする場合は、必ずUSBまた
はイーサネットでモニターが接続されていることを確認してく
ださい。モニター名の横にUSBアイコンが表示されます。

モニター設定

各モニターの設定や表示方法を調整するには、必ずイーサネットまたはUSBで接続されている必要があ
ります。SmartView Setupのホームページの左右の矢印をクリックして、設定を変更するモニターを選択
します。その後、モニター名の下の設定アイコンをクリックします。設定ページは、選択されたBlackmagic
モニターに合わせて、表示する機能を自動的にカスタマイズします。

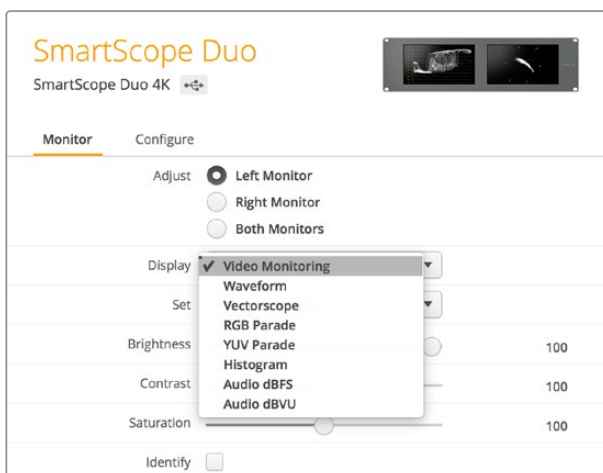

SmartScopeでは「Display」ドロップダウンメニューから、様々な
スコープやビデオモニタリングのオプションを選択できます。

Adjust (調整)

SmartScopeまたはSmartView Duoを使用する場合、調整するモニターを「Left Monitor (左)」、「Right Monitor (右)」、「Both Monitors (両方)」から選択します。「Both Monitors」が選択されている場合、明るさ、コントラスト、サチュレーションに行なった調整はすべて、SmartView Duo/SmartScopeの両方のモニターに適用されます。

Display (ディスプレイ)

SmartScopeを使用する場合は「Display (ディスプレイ)」ドロップダウンメニューに、スコープのオプションが表示されます。ビデオの映像を表示したい場合は「Video Monitoring (ビデオモニタリング)」を選択します。

Set (設定)

SmartScopeを使用する場合は「Set (設定)」ドロップダウンメニューで、SDビデオモニタリングのアスペクトレシオを4:3または16:9から選択できます。「Set」には、選択したモニター用のオプションとしてベクトルスコープ、オーディオのdBFS、dBVUが表示されます。

- **Video Monitoring (ビデオモニタリング)** : ビデオ映像のアスペクトレシオを4:3または16:9から選択します。
ワイドスクリーンのアナモルフィックSDビデオの表示には16:9を選択します。従来型の4:3のSDビデオの表示には4:3を選択します。
- **Vectorscope (ベクトルスコープ)** : 入力に使用されているカラーバーテスト信号に応じて、100%または75%から選択します。
- **Audio dBFS (オーディオdBFS)** : 位相をモニタリングするオーディオチャンネルを選択します。
- **Audio dBVU (オーディオdBVU)** : 位相をモニタリングするオーディオチャンネルを選択します。

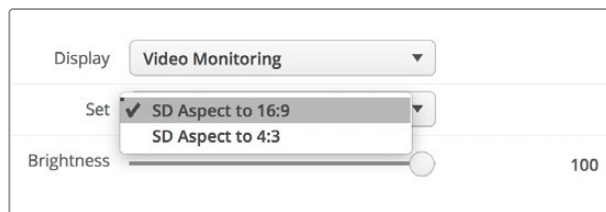

アナモルフィックSDビデオの表示には「SD Aspect to 16:9 (SDアスペクトレシオ16:9)」を選択します。

Brightness, Contrast, Saturation

スライダーを使用して明るさ、コントラスト、サチュレーション設定を調整します。使用できる設定は、SmartViewとSmartScopeのモデルによって異なります。

Identify (モニターの特定)

「Identify」にチェックが入っていると、Blackmagic SmartView Setupで選択されているモニターに白い線が表示されます。ネットワークで複数のSmartViewやSmartScopeを使用している際に、この設定を使用すると、選択されているモニターを簡単に確認できます。

「Both Monitors (両方)」に設定している状態で、この設定を使用すると、白い線はSmartView Duo/SmartScope Duo 4Kの両方のモニターに表示されます。

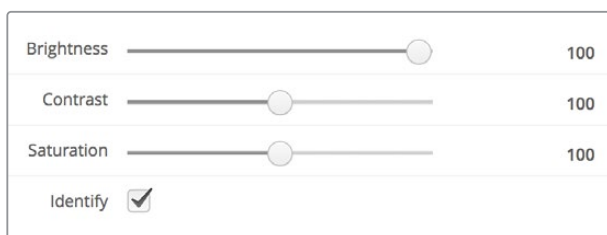

スライダーを動かして、明るさ、コントラスト、サチュレーションを調整します。「Identify」にチェックを入れると、選択しているモニターを視覚的に確認できます。

タリーオーバーライドの有効化

「Enable tally override (タリーオーバーライドの有効化)」を選択すると、Blackmagic SmartView 4Kのタリーボーダーがオンになります。この機能は、Blackmagic URSA Mini Pro 4.6KおよびBlackmagic URSA Broadcastで使用できます。

カメラのSDI出力をSmartView 4Kの入力AまたはBに接続します。

ATEMスイッチャーのプログラム出力をカメラのSDI入力に接続します。

ATEMスイッチャーが、該当のカメラをプログラム出力に切り替えると、SmartView 4Kに赤いタリーボーダーが表示されます。プレビュー出力に切り替えると、タリーボーダーは緑に変わります。

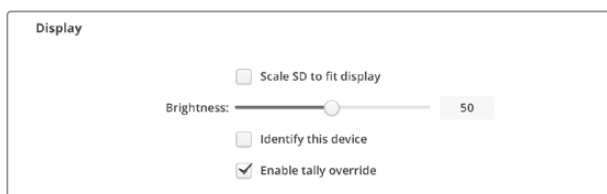

「Enable tally override」チェックボックスをクリックすると、Blackmagic URSA Mini ProまたはURSA BroadcastカメラにSmartView 4Kを接続している場合に、タリーボーダーを使用可能

SmartView 4Kの使用

Blackmagic SmartView 4Kについて

SmartView 4Kは6UラックサイズのUltra HD 12G-SDI放送モニターで、SD/HDに加え、2160p60までのUltra HDビデオをネイティブで表示できます。広視野角の高輝度ディスプレイを搭載したSmartView 4Kの鮮明で極めてクリアな映像を使って、フォーカス合わせやカラーのモニタリングが可能。また、事実上すべてのビデオフォーマットをサポートしています。

スタジオ放送や野外放送での使用を意図してデザインされているため、SmartView 4Kの使用法は非常に簡単です。筐体の側面に配置されたコネクタと、VESAマウントを使用すると、狭い場所への設置、ウォールマウント、連結式アームへの取り付けができます。SmartView 4Kは内蔵のフロントパネルで操作できますが、フロントパネルにアクセスできない場合はイーサネットでもリモートコントロールも可能です。

2系統のマルチレート12G-SDI入力を搭載しているため、2つのSDIソースから選択できます。また、SMPTE準拠SFPモジュール用ソケットを搭載しており、光ファイバーSDIモジュールを追加して光ファイバーでビデオを接続することも可能です。1系統の12G-SDI出力からは、ビデオを他の機器にフィードできます。

また、ネットワーク接続およびリモートコントロール用の2つのイーサネットコネクタ、他のモニターとのデージーチェーン接続用のループ出力も搭載しています。他にも、ライブプロダクション用タリー入力、内部ソフトウェアのアップデート用USBポートを搭載しています。

加えて、Blackmagic SmartView Setupソフトウェアを使って、業界標準の3D LUTを.cube拡張子でロード、またはDaVinci Resolveが生成したLUTを読み込むこともできます。3D LUTを使用すると、SmartView 4Kを直接カメラに接続し、最終的なグレーディングを適用したイメージに最も近い形でクリップを表示できます。フォーカスピーキングは2レベルあり、ショットのフォーカスが完璧に合っているか確認できます。AC/DC電源の両方が利用可能なため、SmartView 4Kを主電源に接続しても、セットで移動しやすい外部バッテリーに接続しても使用できます。

SmartView 4Kは、ポータブルかつスタジオでの制作に最適な放送用モニターで、SD/HDビデオに加え、ネイティブ解像度3840x2160ピクセルのUltra HDに対応しています。



メモ DC電源入力に外部電源を接続している場合、必ず12Vで24Wの電源供給を行える外部電源を使用してください。

コントロールパネルボタン

コントロールパネルには複数のボタンが搭載されており、SmartView 4Kの設定を瞬時に調整できます。

INPUT (入力)

SmartView 4Kの2系統の12G-SDI入力、およびオプションの光ファイバー SFPモジュール入力に接続されているビデオ信号を切り替えます。入力にビデオが接続されていない場合、SmartView 4Kは該当の入力にブラックを表示します。入力を切り替えると、入力のフォーマット情報がモニターの上端左端に一瞬、表示されます。

DISP (ディスプレイ)

SmartView 4KのLCDの明るさを調整します。上下の矢印ボタンを押して、明るさを調整します。「DISP」ボタンを再度押して、設定を閉じます。

H/V DELAY (H/Vディレイ)

SDIビデオ信号にエンベッドされている補助データを確認できます。例えば、「H/V DELAY」ボタンを1回押すと水平方向の補助データが表示されます。同ボタンを再度押すと、縦方向の補助データが表示されます。これは一般的にクローズドキャプションに使用されています。

BLUE ONLY (ブルーオンリー)

デジタルビデオ信号にノイズがある場合、ブルーチャンネルで最も際立って表示されます。「BLUE ONLY」ボタンを押すと、ブルーチャンネルでノイズを簡単にチェックできます。これは、ブルーチャンネルのみを表示する白黒のイメージです。この白黒のイメージをカメラのフォーカス確認のために使用することもできます。

ZOOM (ズーム)

クリアなフォーカスを得るために使用します。1回押すとイメージにズームします。これにより、フォーカスが合っているか、はっきりと確認できます。再度「ZOOM」ボタンを押すと通常の表示サイズに戻ります。

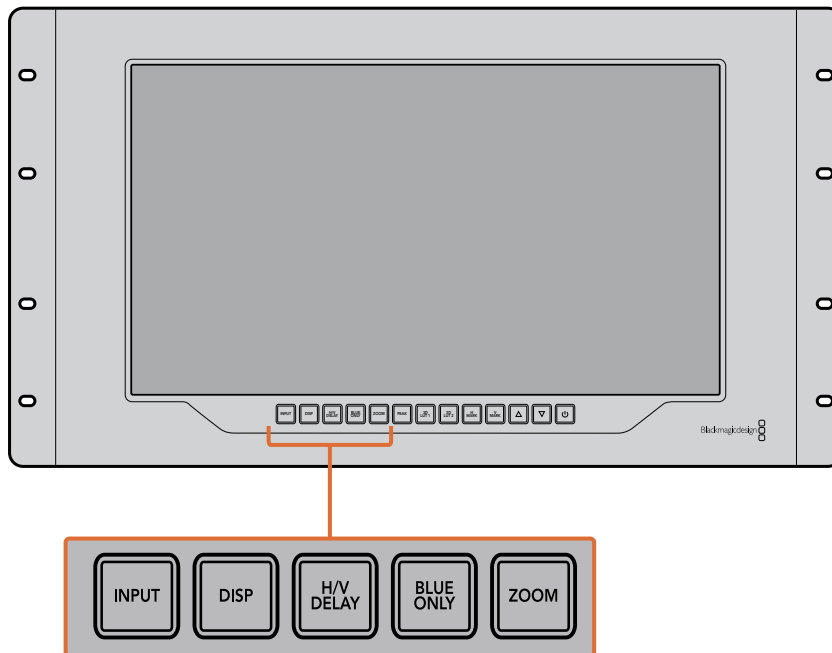

PEAK (ピーク)

フォーカスピーキングを有効にして、カメラのフォーカスを簡単にチェックできます。これは、イメージの最もシャープな部分を緑色で縁取りします。ピーキングの強度は2レベルあり、「PEAK」ボタンを押して切り替えます。緑のエッジが最も強い部分に、カメラのフォーカスが合っています。

3D LUT 1, 3D LUT 2

この機能を使用すると、Blackmagic DaVinci Resolveで生成されたカスタム3D LUT、または業界標準のcube LUTを適用したイメージを確認できます。「LUT」ボタンを押して、LUTを有効にします。再度押すと、LUTは無効になります。SmartView 4Kでの3D LUTの使用に関しては「Blackmagic SmartView Setupで3D LUTをロード」のセクションを参照してください。

H MARK (横方向マーカー)、V MARK (縦方向マーカー)

「H MARK」または「V MARK」ボタンを使ってフレームマーカーの確認と編集が行えます。フレームマーカーは、ショットの構成や、スクリーンのセーフエリア内に重要な情報やグラフィックが配置されているか確認するために使用します。テレビの種類によって、ビデオ信号の端の表示に多少の差があるため、セーフエリアを確認できるのは便利な機能です。セーフエリアは、テレビやモニターの種類に関わらず、必ずスクリーンに表示される領域です。

横方向のフレームマーカーの確認には「H MARK」、縦方向には「V MARK」ボタンを押します。マーカーの編集は、各ボタンを再度押して、それぞれのガイドをハイライトします。これで、上下の矢印ボタンを使って、マーカーの位置を編集できます。各ボタンを再度押すと、新しい配置を確定します。もう一度ボタンを押すとマーカーが無効になります。

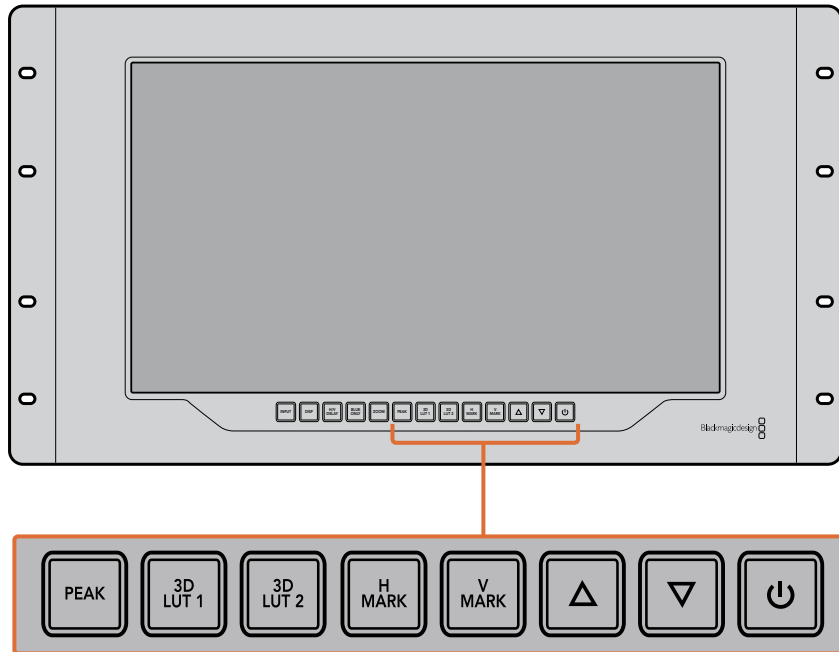

上下の矢印ボタン

設定の調整に使用します。例えば、ディスプレイの明るさやフレームマーカの位置の調整に使用します。

電源

電源ボタンを1度押すと、SmartView 4Kの電源がオンになります。再度押すとオフになります。

Blackmagic SmartView Setupで3D LUTをロード

SmartView 4Kは、ビデオに3D LUTを適用してモニタリングできます。これにより、プロ仕様のキャリブレーションLUTを使用してSmartView 4Kのキャリブレーションを行ったり、最終的なグレーディングを適用したイメージに最も近い形でビデオを表示できます。また、3D LUTを使用して異なるルックを試すこともできます。LUTは、Blackmagic SmartView SetupでSmartView 4Kに読み込み可能で、業界標準のLUTファイルを.cube拡張子でロードできるため、Blackmagic DaVinci Resolveが生成したカスタムLUTもロードできます。LUTファイルの生成についての詳細は、DaVinci Resolveマニュアルを参照してください。

3D LUTを3D LUT 1にロード：

- 1 Blackmagic SmartView Setupを起動します。
- 2 Load LUT 1の「Load」ボタンを押します。ロードするLUTが保存されている場所を入力するウィンドウが開きます。任意の.cubeのLUTファイルを選択して「Open」ボタンを押します。
- 3 読み込んだLUTを確認するには、SmartView 4Kのコントロールパネルの「3D LUT 1」ボタンを押します。LUTをオフにする場合は同じボタンをもう一度押します。

3D LUT 2へのLUTのロードは、上記の手順と同じです。

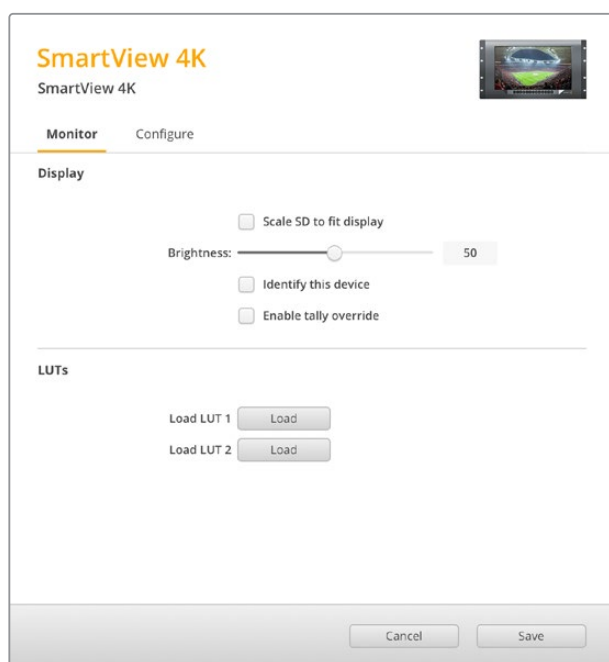

Blackmagic SmartView Setupで3D LUTをSmartView 4Kにロード

SmartScope Duo 4Kの使用

Blackmagic SmartScopeとは

従来、放送品質のテレビポストプロダクション用スコープは、非常に高価なカスタム・ソリューションだった上、小さなスクリーンで1度に1種類のスコープしか使用できませんでした。スコープによっては、見栄えが悪く、クライアントの前での使用に不向きなものもあります。

SmartScope Duo 4Kは、波形モニターをモニタリングに追加でき、デュアルモニターでビデオ信号のあらゆるディテールをリアルタイムで確認できます。Blackmagic SmartView Setupで入力信号に変更を加えると、SmartScope Duo 4Kで直ちに確認できます。さらに、各入力信号はもう一方のモニターにSDI、左側のモニターに送信されている入力信号を、右側のモニターにスコープで表示できます。

SmartScope Duo 4Kに表示されるスコープはBlackmagic SmartView Setupソフトウェアで選択します。「Display」ドロップダウンメニューからスコープを選択します。

下記および次の数ページに渡って、各スコープの使用方法を紹介しているので、それぞれの使い方の理解を深める参考にしてください。

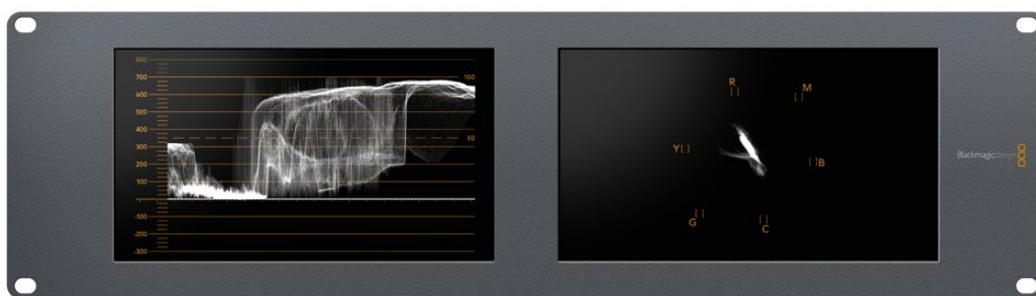

Blackmagic SmartView Setupを使用して、異なるスコープをBlackmagic SmartScope Duo 4Kの 各モニター簡単に表示できます。

ビデオモニタリング表示

Video Monitoring (ビデオモニタリング) 表示は便利かつ信頼性の高いモニターで、SmartScopeが受信しているビデオを確認できます。

SD入力信号の場合「Set」ドロップダウンメニューで、4:3ピラーボックスまたは16:9から表示方法を選択できます。LCDの明るさ、コントラスト、サチュレーションに行なった調整はすべて、この表示で直ちに確認できます。これらの変更はモニターにのみ適用され、ビデオ信号には適用されません。スコープは、サチュレーションや明るさの変更による影響を受けません。

一方のモニターを「Video Monitoring」に設定してビデオを表示し、もう一方でスコープを表示すると便利な場合が多いです。これは、「MONITOR 1」のSDI OUT (ループスルー出力) を「MONITOR 2」のSDI INに短いケーブルで接続することで実行できます。

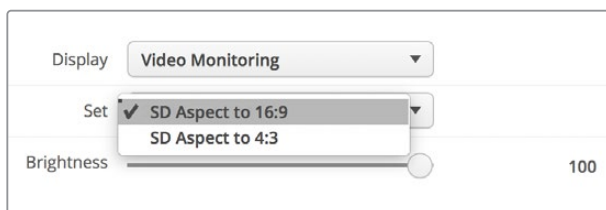

SDビデオは、Blackmagic SmartView Setupの「Set」ドロップダウンメニューで、4:3ピラーボックスまたは16:9ワイドスクリーンから表示方法を選択できます。アナモルフィックSDビデオの表示には「SD aspect to 16:9 (SDアスペクトレシオ16:9)」を選択します。

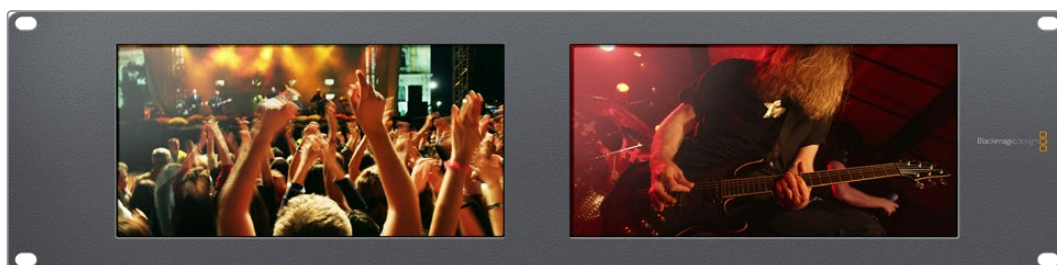

Video Monitoring表示は、テレビ画面やモニターに通常表示されるビデオ信号を表示する設定です。

波形表示

Waveform (波形) 表示は、従来型のルミナンス波形モニターのような、デジタルエンコードされた波形を表示し、ビデオ信号のルマ (輝度) レベルのモニタリングおよび調整に使用します。

従来型のルミナンス波形モニターでは、SDのアナログ・コンポジット映像以外はサポートされていませんでした。しかし、SmartScope Duo 4Kの波形表示はHD/SD/Ultra HDに対応しているため、HDデジタルビデオフォーマットでモニタリングを行っている場合でも、ルマレベルを一貫した方法で簡単に調節できます。

Blackmagic SmartView Setupの「Display」ドロップダウンメニューで「Waveform (波形)」を選択します。波形の黒レベルが0%未満、白レベルが100%を超過しないようにすることで、ルミナンス値の不正レベルを防げます。

波形モニターはイメージをグラフ化したもので、フレーム内のルミナンス値を、位置を反映した形で表示します。例えば、空の一部が露出過多の場合、フレームに表示されるのと同じ横方向の位置に波形が表示されます。

フッテージによって波形の見え方は異なります。コントラストが高いビデオをモニタリングしている場合、中間グレイに値が表示されない可能性があります。下の写真は、均等な露出の画像で、左側に暗い領域があり、フレームの中心から右側にかけて明るい値があることが確認できます。

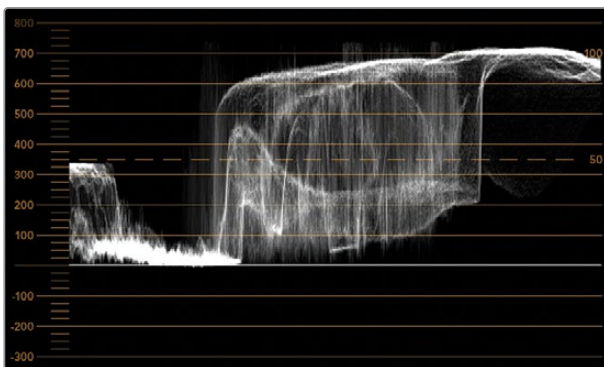

ルミナンス値を表示する波形

Adjust	<input checked="" type="radio"/> Left Monitor
	<input type="radio"/> Right Monitor
	<input type="radio"/> Both Monitors
Display	Waveform ▼
Set	No Options ▼

Blackmagic SmartView Setupの「Display」設定で「Waveform (波形)」を選択して、ビデオ信号のルミナンス値を確認します。

ベクトルスコープ表示

Vectorscope (ベクトルスコープ) 表示では、ビデオ信号の色をベクトルビューで表示します。カラーバーテスト信号の基準に応じて、Blackmagic SmartView Setupの「Set」ドロップダウンメニューで、100%または75%を選択します。

ベクトルスコープを不正レベルのチェックに使用できるとしている人もいますが、それは正しくありません。不正カラーのチェックには、RGBパレード表示を使用します。不正レベルのチェックにベクトルスコープを使用できない理由は、不正レベルの確認にはクロマ/ルミナンスの両方の値をチェックする必要があるからです。例えば、ホワイト/ブラックポイントに近い色は、ルミナンスの中間グレーである色ほど彩度を上げることができません。ベクトルスコープ表示にはカラーのみが表示され、ルミナンス値は表示されないため、単独では不正カラーのチェックには使用できません。

ベクトルスコープ表示は、クロマレベルの調節が必要な古いアナログビデオテープのカラーレベルのチェックには最適なツールです。ビデオテープのカラーバーの部分を生再生し、ビデオのカラーをグラフ内の正方形のボックスに合わせるように、クロマおよび色相設定を調節します。

ベクトルスコープ表示は、ビデオのホワイトバランスが適切か、また、色かぶりがあるかどうか簡単に確認できるためカラーグレーディングにも最適です。ビデオに色かぶりがある場合は、ベクトルスコープ表示が中心から外れ、中心ドットが2つ見える場合があります。通常、ビデオ信号のブランキングによって、ベクトルスコープの中心にドットが生成されます。これは、ビデオのブランキングが色を含まないブラックであるためです。ブランキングは、色情報を含まないブラックビデオの範囲を識別するのに役立ちます。

ビデオに色かぶりが生じている場合は、ブラックが中心からずれます。ずれの度合いは映像の色かぶりの程度を表しています。映像のホワイト/ブラックのディテールでずれを確認できます。この機能は、ベクトルスコープ表示で色かぶりを除去し、正しいホワイトバランスに戻すのに役立ちます。

ベクトルスコープ表示を使用すれば、誤ってブラック/ホワイトに不要な色かぶりを生じさせることなく、ビデオの色を限界まで押し上げることができます。カラーバランスはRGBパレード表示とベクトルスコープ表示の両方でモニタリングできますが、多くの場合、ベクトルスコープ表示の方がカラーバランスの問題を簡単に確認できます。

特に顔など、肌のトーンの色補正を行う際は、ベクトルスコープの10時くらいの線に沿うようにすると、温かいカラーサチュレーションを保てます。これは「フレッシュトーン・ライン」と呼ばれ、皮膚の下にある血液の色に基づいたラインです。したがって、フレッシュトーン・ラインは、あらゆる肌の色に適用でき、出演者の肌のトーンを自然な色に見せることができます。

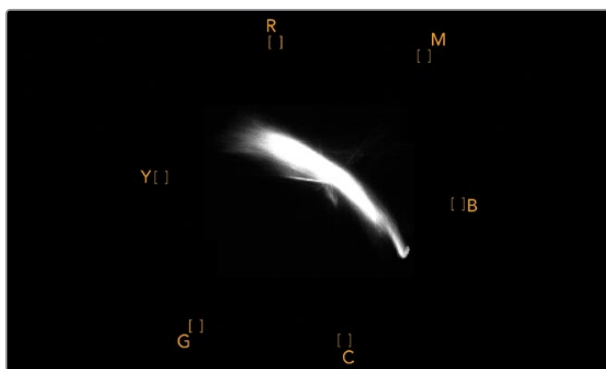

10時の線に沿う「フレッシュトーン・ライン」を表示するベクトルスコープ

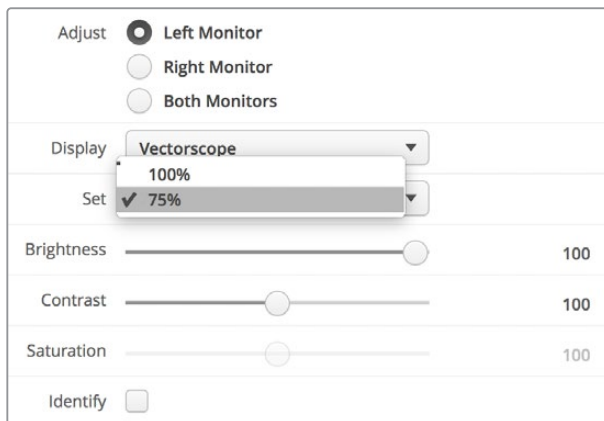

ベクトルスコープでカラーバーテスト信号を100%または75%に選択

パレード表示

RGBおよびYUVパレード表示はカラーコレクション、不正カラー、レベルのチェックに最適です。

カラーコレクションを行う際は、Blackmagic SmartView Setupの「Display」ドロップダウンメニューで「RGB Parade (RGBパレード)」を選択します。RGB Parade表示は、赤、緑、青の各カラーチャンネルの全長を表示します。各カラーチャンネルのレベルをモニタリングすることで、ビデオ信号のブラック、中間、ホワイトのカラーバランスを簡単に確認できます。RGBパレードは、赤、緑、青のチャンネルに共通のディテールを確認でき、カラーバランスの調整や色かぶりの除去が簡単に行えます。

カラーコレクションを行う上で、ビデオレベルをクリッピングしない範囲で最大限にすることが重要です。ビデオレベルを上げる場合は、RGBの上限を超えないように注意してください。超過すると不正レベルになります。機器によっては、不正であるRGBレベル100%を生成できないものもありますが、生成できる機器もあります。SmartScope Duo 4Kでは、不正レベルが生じた場合すぐに確認できます。

また、不正ビデオレベルは黒/白レベルでも生じます。一部のカラーコレクションシステムでは、黒レベルは0%のブラックポイントを下回ることができます。不正な黒レベルが見られる場合は、「リフト」または「ゲイン」を上げて、適切な値になるように調整します。同時に、目盛線の100%を確認しながら、ビデオ信号全体が上がりすぎて、白が不正なレベルにならないように調整します。

YUVレベルの確認は「Display」ドロップダウンメニューで「YUV Parade (YUVパレード)」を選択します。これは、ルマ (輝度) 値がクロマ (色) 値とは別に表示されるので、テレビ放送用のビデオ信号にとって便利なスコープです。左にはルマの情報が表示され、中央と右はクロマの情報が表示されます。YUVパレードは、ビデオ信号のクロマ値をカラーバーのテストパターンにを使ってキャリブレーションする際に便利なスコープです。これにより、カラーが的確に表現され、放送される信号がテレビで表示可能か確認できます。

カラーコレクションは、不正レベルを生じさせずに最も美しいロックの得るために調整を繰り返す作業です。

カラーコレクション用語

ブラック/黒 - ビデオ信号の黒レベル

ミッド/中間 - ビデオ信号の中間グレーのレベル

ホワイト/白 - ビデオ信号の白レベル

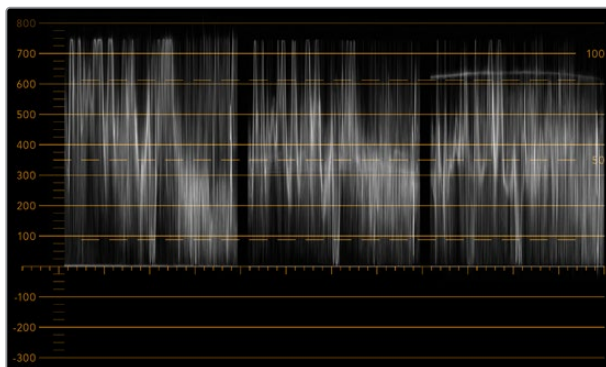

RGBパレード

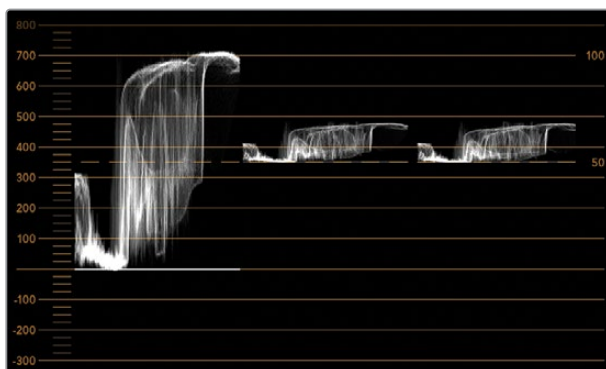

YUVパレード

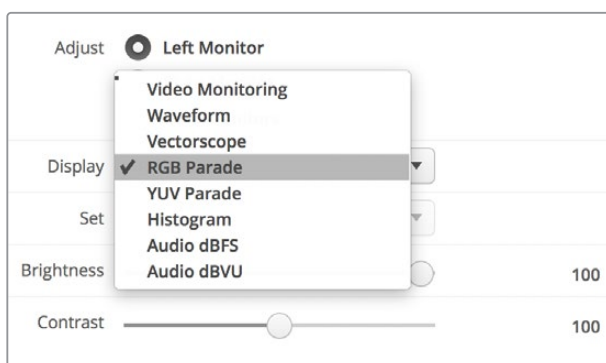

Blackmagic SmartView Setupの「Display」ドロップダウンメニューで「RGB Parade (RGBパレード)」と「YUV Parade (YUVパレード)」を切り替えます。

ヒストグラム表示

Histogram (ヒストグラム) 表示は、多くのグラフィックデザイナーやカメラマンにとって馴染みのあるスコープです。ヒストグラム表示では、白から黒までの配分情報が表示され、映像内のクリッピングされているホワイト/ブラックのディテールが詳細に確認できます。また、ヒストグラム表示ではビデオのガンマ変更の効果が確認できます。

ブラックビデオはディスプレイの左側に表示され、ホワイトは右側に表示されます。通常、ビデオはすべてヒストグラム表示の0%から100%の間に表示されます。ビデオが0%未満や100%を超える場合、そのビデオはクリッピングされています。撮影時に生じるビデオのクリッピングは非常に悪い結果につながりかねません。これは、後に管理された環境でカラーコレクションを行う場合、ブラック/ホワイトのディテールを必ず維持しておく必要があるためです。撮影時にビデオを黒および白のしきい値内に保つようすることで、白飛びや黒つぶれ、ディテールの損失などを避け、後の作業で自由にカラーコレクションを行えます。

カラーコレクションを施す際、ビデオをクリッピングさせたい場合があるかもしれません。その場合、ヒストグラム表示には、ビデオクリッピングの結果およびクリッピングされている範囲が表示されます。または、ガンマを使用することで、ディテールを保ったまま、少ないクリッピングで同様のルックが作成できます。

ヒストグラム表示では、不正な黒/白レベルの確認はできますが、不正カラーレベルのチェックはできません。ヒストグラム表示は色を表示しないため、ビデオに不正カラーが含まれていても、規定の範囲内の色として表示される場合があります。不正レベルとカラーのチェックには、ビデオ信号の色とルミナンスを両方表示するRGBパレード表示が最適です。

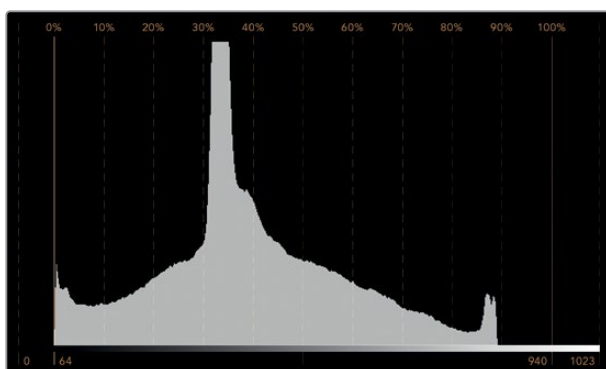

ホワイトからブラックの配分を表示するヒストグラム表示

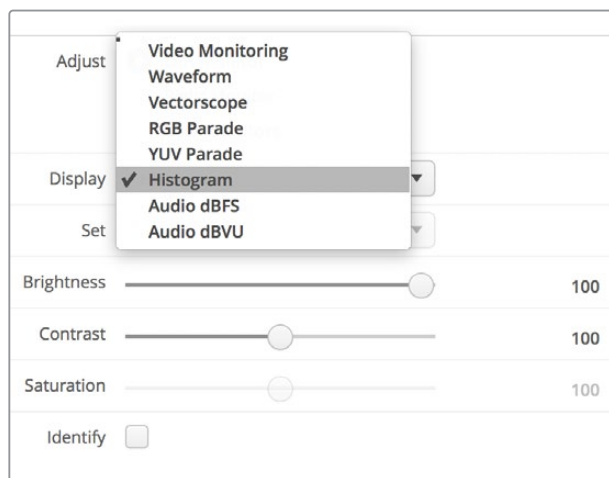

Blackmagic SmartView Setupの「Display」ドロップダウンメニューで「Histogram (ヒストグラム)」を選択します。

オーディオメーター表示

オーディオメーター表示は、SDIビデオ信号のエンベデッドオーディオのオーディオレベルを表示します。最大16チャンネルのエンベデッドオーディオがデエンベッドされ、dBVUまたはdBFSフォーマットで表示されます。

VUメーターは、信号の平均レベルを表示し、従来型の機器で非常に多く使用されている、使いやすいメーターです。VUは、SMPTEの推奨する1 kHz/-20 dBFSテストトーン信号にキャリブレーションされています。

dBFSは、基本的にはデジタルオーディオ信号全般のメーターで、近代的なデジタル機器に一般的に使用されています。

右のオーディオスコープでは2チャンネルのオーディオをモニタリングでき、チャンネルの選択は「Set」ドロップダウンメニューで行います。例えば、チャンネル1と2、チャンネル3と4。オーディオスコープにはオーディオがX-Yビューで表示されるため、オーディオバランスの問題、位相のずれ、またはオーディオがモノラルかステレオか確認できます。モノラルオーディオは「In Phase」のライン上に1本の縦の線が表示されます。線が水平方向に表示される場合は、オーディオの「位相がずれて」おり、ダウンストリーム機器に送られた際に無効（例：オーディオの損失など）になる場合があります。ケーブル類が正しく接続されていない場合のある大規模な施設などでは、位相のずれは最も多く見られるオーディオ不具合のひとつです。

ステレオ信号をモニタリングしている場合、右のオーディオスコープのオーディオ信号の広がり、左右のオーディオチャンネルの差異を示します。オーディオトラックに含まれるステレオサウンドが多いほど、オーディオ信号を示すラインは円形に広がっていきます。オーディオに含まれるステレオサウンドが少ない場合は、ディスプレイの表示はより垂直軸に集中します。

会話のオーディオは垂直線のように表示されることが多い一方、ステレオサウンドを多く含む音楽のスコープは広がって表示されます。これは、モノラルオーディオではLとRが同一であるため垂直軸上に表示される一方で、ステレオではLとRが異なり、水平軸上にLRの差異を示す形で表示されるためです。

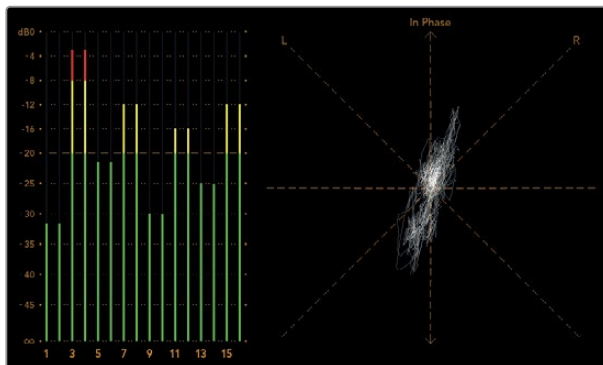

ピークレベルとオーディオバランスを表示するオーディオメーター表示

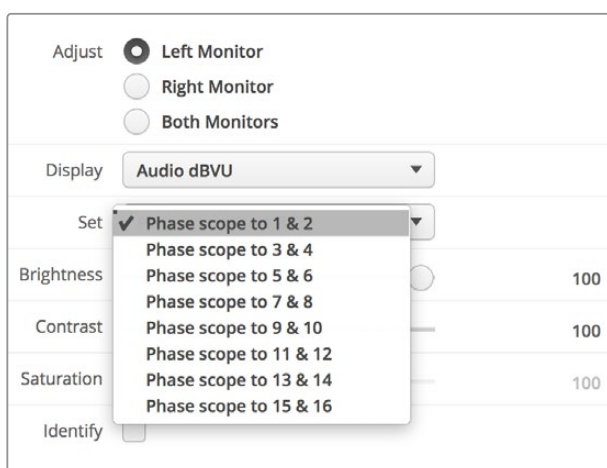

「Set」ドロップダウンメニューからモニタリングするオーディオチャンネルを選択

ネットワークに接続

SmartView/SmartScopeモニターをネットワークに接続すると、複数のユニットのモニター設定をリモートで調整できます。

SmartView/SmartScopeモニターは、コンフィギュレーションを行わずにビデオを表示できますが、すべてのネットワーク設定を配置前に設定する必要があります。ネットワークのコンフィギュレーションは、コンピューターに直接USBで接続されている際のみ実行できます。

ダイレクト・イーサネット

リモートでのモニタリングには、コンピューターに直接イーサネットでモニターを接続して行う方法があります。この方法ではネットワークスイッチは必要ないため、急いでインストールとセットアップを行う際に便利です。ユニットを追加するには、各ユニットのアクティブなイーサネットのループスルーを介して、デジーチェーンで接続します。この際、チェーン上の全ユニットに電源が供給されている必要があります。

スタジオの既存のネットワークのIPアドレスを使わずに複数のユニットを接続したい場合や、ネットワーク自体がない場合、コンピューターのイーサネットポートに直接接続するだけで使用できます。この方法では、ネットワークスイッチにケーブルを配線する必要がないため、SmartView/SmartScopeをすばやくイーサネットを介して接続できます。

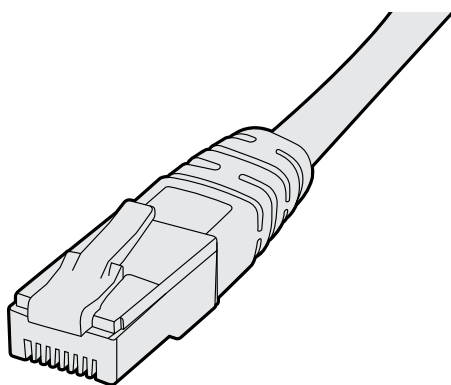

イーサネットコネクター

イーサネット・ネットワークスイッチ

複数のユニットをスタジオのネットワークに接続する場合、ネットワークスイッチにSmartView/SmartScopeを1台接続するだけで、残りのユニットは各ユニットのアクティブなイーサネットのループスルーを介して、デージーチェーンで接続できるため、スイッチのポートを複数使用する必要はありません。これにより、ネットワークスイッチに複数のケーブルを配線する必要がありません。その際、デージーチェーン上の全ユニットに電源が供給されている必要があります。

ネットワークスイッチに接続すると、ネットワーク上のあらゆるコンピューターからユニットの設定を変更できます。また、ネットワークにワイヤレスアクセスポイントがある場合、あらゆるMacまたはWindowsラップトップからWiFi接続で設定を変更できます。

IPベースのネットワークのローカルエリアへのSmartView/SmartScopeの接続は、下記の手順に従ってください。

- 1 ユニットに同梱されている電源ケーブルをしっかりと接続し、スイッチをオンにします。
- 2 標準RJ45イーサネットケーブルを使用して、ネットワークスイッチ、あるいは直接コンピューターに接続します。

ダイレクト・イーサネット接続図

ネットワークスイッチを使わずに、コンピューターのイーサネットポートに直接ユニットを接続できます。ユニットはデージーチェーン接続で追加できるため、ネットワークスイッチに複数のケーブルを配線する必要はありません。全ユニットに電源が供給されている必要があります。

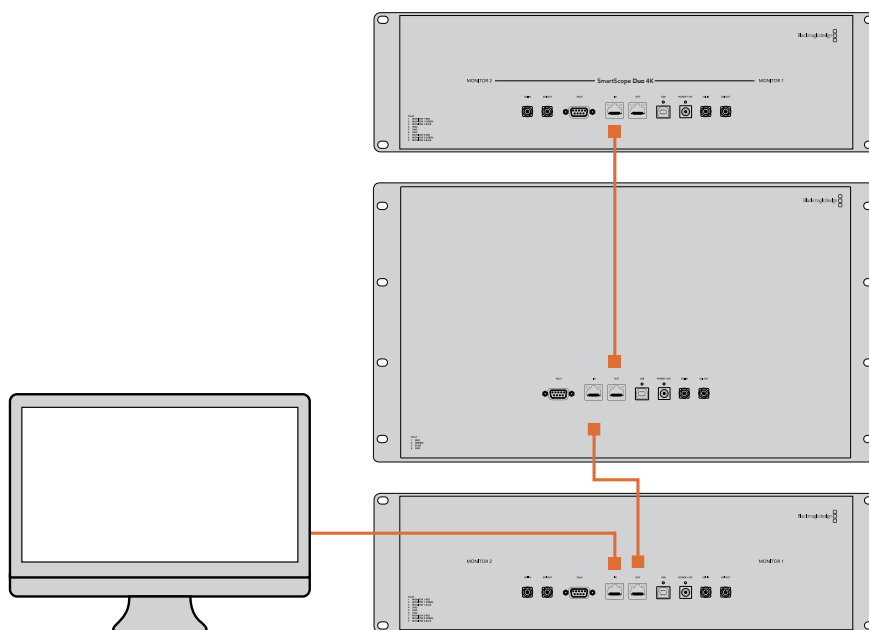

イーサネット・ネットワークスイッチ接続図

スタジオの既存のネットワークのIPアドレスを使わずに複数のユニットを接続したい場合、ネットワークに接続するユニットは1台だけです。残りのユニットはデ이지ーチェーン接続で追加できるため、ネットワークスイッチに複数のケーブルを配線する必要はありません。全ユニットに電源が供給されている必要があります。

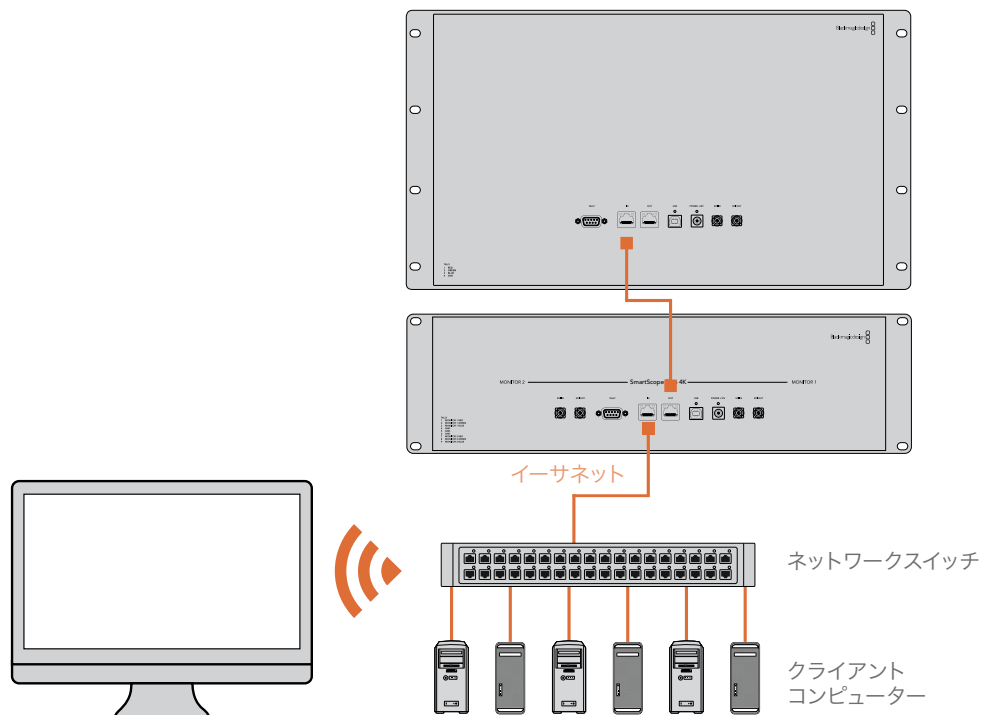

ネットワーク設定の調整

ネットワーク設定

デバイス名

各モニターに個別の名前をつけることで、ネットワークのSmartViewやSmartScopeを簡単に識別できます。(例: 屋外カメラ1&2、マルチビュー出力、4Kフィードなど)

モニター名を変更する場合は、必ずイーサネットまたはUSBでモニターが接続されていることを確認してください。Blackmagic SmartView Setupを起動し、モニター名の下の設定アイコンをクリックします。設定ページで「Network (ネットワーク)」をクリックして、「Details (詳細)」の欄のモニター名を編集します。入力した名前が無効の場合、フィールドの横に警告アイコンが表示されます。有効の場合、緑のチェックマークが表示されます。コンピューターのキーボードの「Return」キーを押して名前の変更を確定します。

ネットワーク設定

Blackmagic SmartView Setupのネットワーク設定セクションに変更を加える場合は、Blackmagicモニターは必ずUSBでコンピューターに接続されている必要があります。ネットワーク設定は、イーサネットでは調整できません。

デフォルトでは、SmartView/SmartScopeはDHCPを使って自動的にネットワークからIPアドレスを取得します。

DHCPサーバーがない場合、macOSの「Internet Sharing」機能、Windows 8.1または10の「Internet Connection Sharing (ICS)」機能を有効にし、直接接続しているユニットがDHCPアドレスを受信できるようにします。これにより、マニュアルで固定IPアドレスを割り当てる必要がありません。この機能を使うと、コンピューターがインターネットに接続されていない場合でもDHCPアドレスを受信することができます。インターネットシェアリングの詳細は、macOSまたはWindows 8.1および10のマニュアルなどを参照してください。

使用しているコンフィギュレーションでDHCPが使えない場合、「Static IP (固定IP)」を選択してアドレスを割り当てます。ネットワークでIPアドレスの競合を防ぐために、システム管理者にスベアのIPアドレスを確認してください。各SmartView/SmartScopeには独自のIPアドレスを使用し、共通のサブネットマスクを指定する必要があります。インターネットルーターなどのネットワークゲートウェイに接続する予定がなければ「Gateway (ゲートウェイ)」のデフォルト値を変える必要はありません。

ネットワークでSmartViewやSmartScopeが検出されない場合、DHCP経由でIPアドレスを受信していない可能性があるため、各ユニットに適切なネットワーク設定をマニュアルで設定する必要があります。

- 1 コンピューターとBlackmagic SmartView/SmartScopeをUSBで接続し、Blackmagic SmartView Setupソフトウェアを起動します。
- 2 接続されたモニターは自動的にSmartView Setupのホームページを表示し、モニター名の隣にUSBのアイコンを表示します。
- 3 モニターのネットワーク設定を調整します。
- 4 DHCP経由でIPアドレスを受信していないユニットすべてに上記の手順で設定を行います。

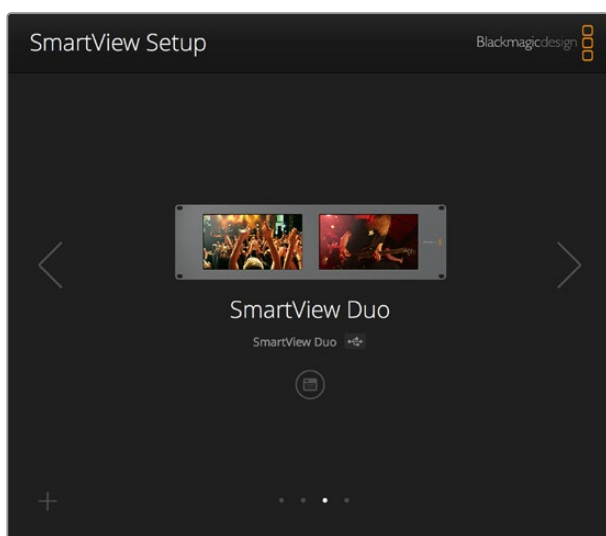

モニター名の隣のUSBアイコンは、モニターがUSBでコンピューターに接続されていることを示します。ネットワーク設定を調整する際は、BlackmagicモニターはUSB接続されている必要があります。

Monitor Configure	
Details	
Name:	SmartView Duo
Software Version:	4.0.1
Network Settings	
IP setting:	<input type="radio"/> DHCP <input checked="" type="radio"/> Static IP
IP Address:	192.168.10.42
Subnet Mask:	255.255.255.0
Gateway:	192.168.10.1
<input type="button" value="Cancel"/> <input type="button" value="Save"/>	

ネットワーク設定はDHCPまたは固定IPアドレスのいずれでも設定でき、USB経由でのみ変更可能。

Blackmagicモニターの追加

SmartView/SmartScope Duo 4KのIPアドレスが既に分かっている場合、Blackmagic SmartView Setupのホームページに自動的に表示されない場合、モニターをマニュアルで追加できます。

マニュアルでのモニター追加:

- 1 必ずイーサネットでBlackmagicモニターが接続されていることを確認してください。左下の「+ (プラス)」をクリックすると「Add a [Blackmagicモニターのモデル名]」ウィンドウが開きます。
- 2 IPアドレスを入力し、「Add (追加)」をクリックします。
- 3 ソフトウェアがユニットの有無を検証し、SmartView SetupのホームページにBlackmagicモニターが追加されます。右矢印のアイコンをクリックして、新しいモニターが追加されたことを確認します。

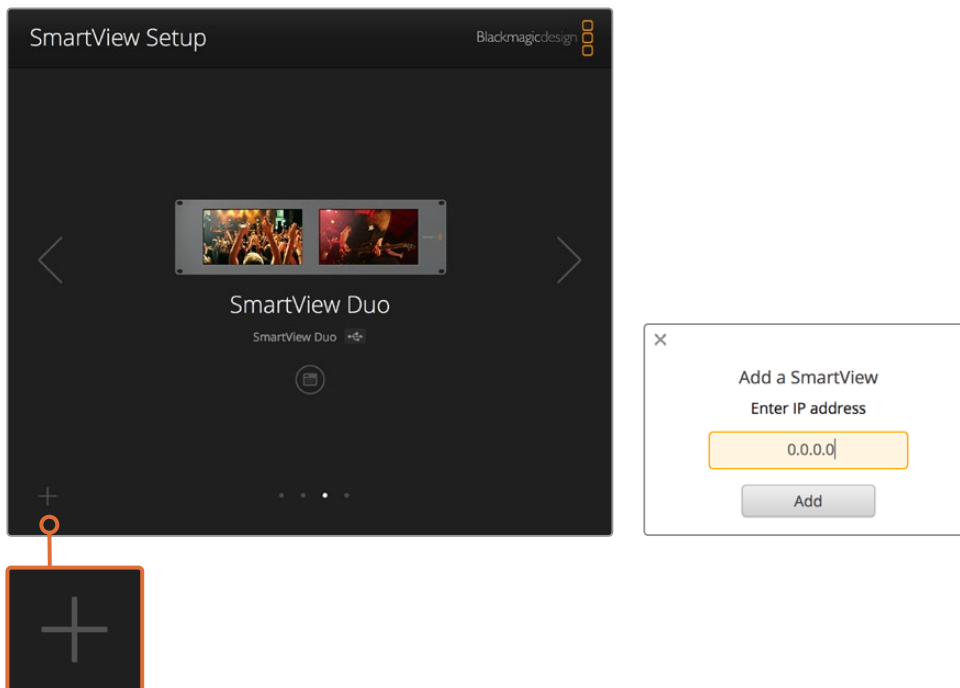

SmartView/SmartScopeは「+」アイコンをクリックするか、IPアドレスを入力してマニュアルで追加可能。

タリーの使用

タリーポートのピン接続

SmartView/SmartScopeのタリーは必ずしも使用する必要はありません。将来的にタリーを使用する予定がなければ、このセクションを読む必要はありません。

各SmartViewやSmartScopeはタリーボーダーを赤、緑、青で表示できる機能を搭載しているため、オンエア、プレビュー、収録などのビデオ信号のステータスのインジケータとして使用できます。

9ピンDサブポートは、スイッチャーやオートメーションシステムからのコンタクト・クロージャー信号に対応しています。スイッチャーやオートメーションシステムと併用する際のタリーポートの配線に関しては下記のタリーのピン接続の表を参照してください。

9ピンDポートの配線に関する情報は、ユニットの背面に印刷されています。個別のモニターで赤、緑、青のタリーボーダーを表示するコンタクト・クロージャーが記載されています。

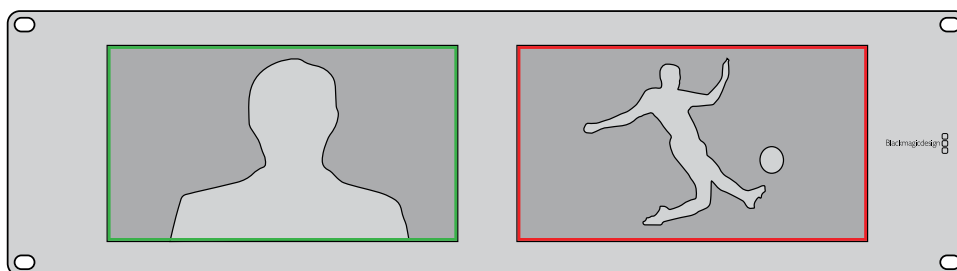

緑と赤のボーダーを表示しているSmartView Duo

SmartView Duo、SmartScope Duo 4K タリーのピン接続	
ピン	機能
1	モニター1、レッド
2	モニター1、グリーン
3	モニター1、ブルー
4	グラウンド
5	グラウンド
6	グラウンド
7	モニター2、レッド
8	モニター2、グリーン
9	モニター2、ブルー

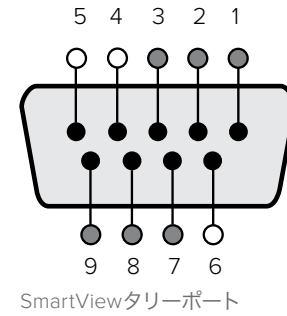

SmartView HD、SmartView 4K タリーのピン接続	
ピン	機能
1	レッド
2	グリーン
3	ブルー
4	グラウンド

ビューアングルの最適化

SmartView Duo、SmartView HD、SmartScopeを機材ラックの高い位置に設置する場合、最適なビューアングルを得るためにLCDの向きを物理的に変えることができます。LCDのイメージは、向きが変わったことを検知した場合に自動で適切な方向に変わります。背面アッセンブリーからフェースプレートを取り外し、取り付けのためにポジドライブのNo.2が必要です。これはシンプルな作業で背面アッセンブリーを開ける必要はありません。

下記の手順に従って、フェースプレートのBlackmagic Designのロゴを正しい向きに保ったまま、ユニットの向きを変えます。ポジドライブのNo.2が必要です。

- 1 フェースプレートの上下左右からネジを外します。SmartView DuoおよびSmartScope Duo 4Kには10個のネジ、SmartView HDには18個のネジがあります。
- 2 図のように背面アッセンブリーからフェースプレートを取り外します。
- 3 背面アッセンブリーを逆向きにします。
- 4 逆向きにした背面アッセンブリーをフェースプレートに戻します。
- 5 筐体にネジで固定します。

SmartView/SmartScopeをラックの高い位置に取り付ける準備ができました。ラックにボルト付けされたら、ぶつかっても調整がずれたり、外れたりする外部ノブや調整部品がないため、SmartViewのビューアングルは最適な状態が保たれます。



機材ラックの高い位置にボルト付けする前に、ビューアングルが最適な状態に維持されるかテストすることを推奨します。

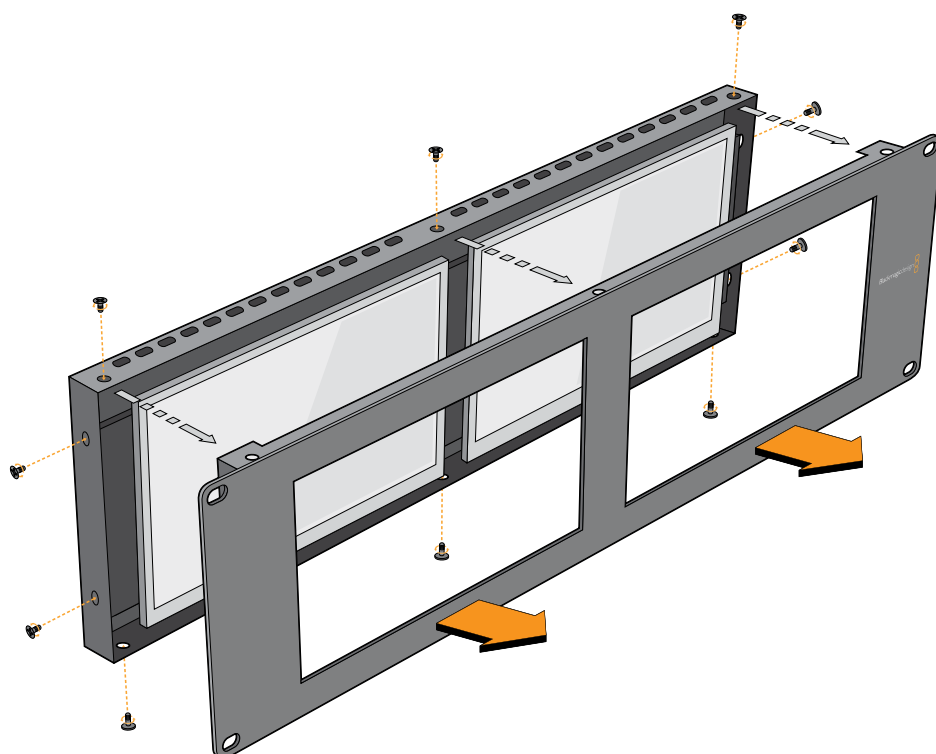

すべてのネジを取り外し、背面アセンブリーからフェースプレートを取り外す。

Developer Information

Developing Custom Software Using Blackmagic Design Hardware

The Blackmagic SmartView Ethernet Protocol allows developers to remotely control Blackmagic SmartView and SmartScope hardware with their own custom software. The Blackmagic SmartView Ethernet Protocol is a text-based status and control protocol.

Downloading the Free SmartView Ethernet Protocol

The Blackmagic SmartView Ethernet Protocol is free. It is included in this SmartView & SmartScope manual and can be downloaded from www.blackmagicdesign.com/jp/support

Joining the Blackmagic Design Developer List

The Blackmagic Developer mailing list is designed for technical questions regarding technologies used by Blackmagic Design, e.g., QuickTime, Core Media, DirectShow, codecs, APIs, SDKs, etc. The free mailing list is a forum where developers can discuss ideas and problems with other developers. Any subscriber may reply and the Blackmagic Design engineers may also respond when appropriate. You can subscribe to the mailing list at:

<http://lists.blackmagicdesign.com/mailman/listinfo/bmd-developer>

In some cases, we might request a brief outline of the software you are developing if it is not immediately obvious from your domain name that your organization develops video software. Please don't take offence as we're simply trying to keep the list free of spam and viruses as well as end-user customers asking non-development questions, employment agents or sales people trying to promote products on the list. The list is just for developers.

Contacting Blackmagic Design Developer Assistance

You can also contact us via developer@blackmagicdesign.com if you have any developer related questions or wish to ask questions off the list.



Blackmagic 2K Format – Overview

Blackmagic Design products support 3G-SDI video, which allows twice the data rate of traditional HD-SDI video. We thought it would be a really nice idea to add 2K film support, via 3G-SDI technology, so we could simplify feature film workflows. With the popularity of Blackmagic Design editing systems worldwide, now thousands of people can benefit from a feature film workflow revolution.

This information includes everything product developers need to know for building native 2K SDI equipment. Of course, all Blackmagic products can be updated, so if the television industry adopts an alternative SDI-based film standard, we can add support for that too!

Frame Structure

- Transmitted at 23.98, 24 or 25 frames per second as a Progressive Segmented Frame.
- Active video is 2048 pixels wide by 1556 lines deep.
- Total lines per frame : 1650
- Active words per line are 1535. One word consists of a 10-bit sample for each of the four data streams, i.e., a total of 40 bits. See the diagram named Blackmagic 2K Format - Data Stream Format.
- Total active lines : 1556
- Total words per line : 1875 for 23.98/24Hz and 1800 for 25Hz.
- Fields per frame : 2, 825 lines each
- Active lines located on lines 16-793 (field 1) and 841-1618 (field 2).

Transport Structure

- Based on SMPTE 372M Dual Link mapping and SMPTE 425M-B support for mapping SMPTE 372M into a single 3 Gb/s link.
- Timing reference signals, line number and line CRC insertion is the same as above.
- During active video, 10-bit Red, Green and Blue data is sent in the following sequence:
- Optional ancillary data is inserted into both virtual interfaces.
- At present, only audio data is included: as per standard HD audio insertion (SMPTE S299M) the audio data packets are carried on data stream two and audio control packets are carried on data stream one.
 - Data stream 1: Green_1, Green_2, Green_3, Green_5...Green_2047
 - Data stream 2: Blue_1, Blue_2, Green_4, Blue_5...Green_2048.
 - Data stream 3: Red_1, Blue_3, Blue_4, Red_5...Blue_2048.
 - Data stream 4: Red_2, Red_3, Red_4, Red_6...Red_2048.

Blackmagic 2K Format – Vertical Timing Reference

This diagram shows the vertical timing details with line numbers and Field, Vertical and Horizontal bits for the Timing Reference Signal codes.

		Field 1					Active					
F	1	0	0	0	0	0	0	0	0	0	0	0
V	1	1	1	1	1	1	0	0	0	0	1	1
LINE #	1650	1	2	...	14	15	16	...	792	793	...	825

		Field 2					Active					
F	0	1	1	1	1	1	1	1	1	1	1	1
V	1	1	1	1	1	1	0	0	0	0	1	1
LINE #	825	826	827	...	839	840	841	...	1617	1618	...	1650

Blackmagic 2K Format – Data Stream Format

This diagram shows the data stream formats around the optional ancillary data section of the horizontal line. Note that each active pixel takes up three samples.

Word# 25 PsF	Word# 23.98/24 PsF	Data Stream 4	Data Stream 3	Data Stream 2	Data Stream 1
1795	1870	R2042	R2041	B2041	G2041
1796	1871	R2043	B2043	B2042	G2042
1797	1872	R2044	B2044	G2044	G2043
1798	1873	R2046	R2045	B2045	G2045
1799	1874	R2047	B2047	B2046	G2046
1800	1875	R2048	B2048	G2048	G2047
1	1	EAV(3FFh)	EAV(3FFh)	EAV(3FFh)	EAV(3FFh)
2	2	EAV(000h)	EAV(000h)	EAV(000h)	EAV(000h)
3	3	EAV(000h)	EAV(000h)	EAV(000h)	EAV(000h)
4	4	EAV(XYZh)	EAV(XYZh)	EAV(XYZh)	EAV(XYZh)
5	5	LN0	LN0	LN0	LN0
6	6	LN1	LN1	LN1	LN1
7	7	CRC0	CRC0	CRC0	CRC0
8	8	CRC1	CRC1	CRC1	CRC1
9	9	200	040	ANC/Audio Data	ANC/Audio Data
...		
260	335	200	040		
261	336	SAV(3FFh)	SAV(3FFh)	SAV(3FFh)	SAV(3FFh)
262	337	SAV(000h)	SAV(000h)	SAV(000h)	SAV(000h)
263	338	SAV(000h)	SAV(000h)	SAV(000h)	SAV(000h)
264	339	SAV(XYZh)	SAV(XYZh)	SAV(XYZh)	SAV(XYZh)
265	340	R2	R1	B1	G1
266	341	R3	B3	B2	G2
267	342	R4	B4	G4	G3
268	343	R6	R5	B5	G5

Blackmagic SmartView Ethernet Protocol v1.3

Summary

The Blackmagic SmartView Ethernet Protocol is a text-based status and control protocol, very similar in structure to the Videohub protocol, that is accessed by connecting to TCP port 9992 on a SmartView or SmartScope device.

Upon connection, the SmartView or SmartScope device sends a complete dump of the state of the device. After the initial dump, state changes are sent asynchronously.

The device sends information in blocks which have an identifying header, followed by a colon. A block can span multiple lines and is terminated by a blank line.

To be resilient to future protocol changes, clients should ignore blocks they do not recognize, up to the trailing blank line. Within recognized blocks, clients should ignore lines they do not recognize.

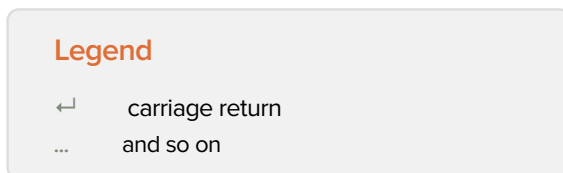

Version 1.3 of the Blackmagic SmartView Ethernet Protocol was released with SmartView 1.3 software.

Protocol Preamble

The first block sent by the SmartView Server is always the protocol preamble:

```
PROTOCOL PREAMBLE:↵  
Version: 1.3 ↵  
↵
```

The version field indicates the protocol version. When the protocol is changed in a compatible way, the minor version number will be updated. If incompatible changes are made, the major version number will be updated.

Device Information

The next block contains general information about the connected SmartView or SmartScope device.

```
SMARTVIEW DEVICE:↵  
Model: SmartView Duo↵  
Hostname: stagefront.studio.example.com↵  
Name: StageFront↵  
Monitors: 2↵  
Inverted: false↵  
↵
```

This example shows the output for a SmartView Duo device, which has two LCDs. The INVERTED flag indicates whether the device has detected that it has been mounted in an inverted configuration to optimize LCD viewing angle.

Network Configuration

The next block shows the TCP/IP networking configuration:

```
NETWORK:↵  
Dynamic IP: true↵  
Static address: 192.168.2.2↵  
Static netmask: 255.255.255.0↵  
Static gateway: 192.168.2.1↵  
Current address: 192.168.1.101↵  
Current netmask: 255.255.255.0↵  
Current gateway: 192.168.1.1↵  
↵
```

The network settings prefixed with CURRENT show the active TCP/IP settings, and are read-only. The CURRENT settings reflect either the DHCP or Static configuration, depending on the DYNAMIC IP flag.

Changing Networking Settings

The network can be configured to use either DHCP or a static configuration. To enable DHCP:

```
NETWORK:↵  
Dynamic IP: true↵  
↵
```

To set a fixed IP address, supply all static parameters, thus:

```
NETWORK:↵  
Dynamic IP: false↵  
Static address: 192.168.2.2↵  
Static netmask: 255.255.255.0↵  
Static gateway: 192.168.2.1↵  
↵
```

The parameters with the CURRENT prefix are read-only, and show the active configuration, regardless of the static or dynamic setting.

Changing the device name, or any network settings, will cause the IP connection to be dropped. The device will restart its networking and advertise its new name on the network.

Changing Monitor Settings

The display settings for each monitor are specified individually. One or more parameters can be modified at the same time and multiple settings can be supplied in one block.

The valid range for numeric values is 0-255. The CONTRAST and SATURATION properties are zero-centered, so the normal value is 127, such that the displayed picture is the same as the original. A value greater than 127 in either channel will cause the contrast or saturation to be increased, and similarly a value less than 127 will cause a decrease.

For example, to set the brightness to 50% and desaturate the image to Black & White:

```
MONITOR A:↵  
Brightness: 127↵  
Saturation: 0↵  
↵
```

Displaying SD in 16:9

The following command sets standard definition video to display in 16:9:

```
MONITOR A:↵  
WidescreenSD: ON↵
```

Displaying SD in 4:3

The following command sets standard definition video to display in 4:3:

```
MONITOR A:↵  
WidescreenSD: OFF↵
```

Identification and Tally Settings

The Identify flag is transient, and will cause a white border to be displayed around the entire picture for a duration of 15 seconds, after which it will be reset. This feature is primarily aimed at identifying which monitor is currently being configured when it is mounted in a rack comprising multiple units. To turn on:

```
MONITOR A:↵  
Identify: true↵  
↵
```

The IDENTIFY border will temporarily override any other border setting in effect.

The BORDER property can be used to programmatically set the soft Tally colored borders to one of the primary colors: RED, GREEN, BLUE, WHITE or NONE. This setting can be overridden by the electrical Tally signals at the DB-9 input on the device itself. For example, to set the soft Tally to green:

```
MONITOR B:↵  
Border: green↵  
↵
```

The hard wired tally will always override the soft tally. The full state report will always show the current valid border.

SmartScope Settings

On SmartScope Duo 4K, each monitor can be set to display a different scope. The values for activating specific scopes are mapped as follows:

- AudioDbfs
- AudioDbvu
- Histogram
- ParadeRGB
- ParadeYUV
- Picture (This is the same as Video Monitor)
- Vector100
- Vector75
- WaveformLuma

```
MONITOR A:↵  
ScopeMode: Picture↵  
↵
```

In the example above, Monitor A has been set as a video monitor.

Displaying SD in 16:9

The set Video Monitor mode to display standard definition video in 16:9:

```
MONITOR A:↵  
ScopeMode: Picture↵  
WidescreenSD: ON↵
```

Displaying SD in 4:3

To set Video Monitor mode to display standard definition video in 4:3:

```
MONITOR A:↵  
ScopeMode: Picture↵  
WidescreenSD: OFF↵
```

When setting one of SmartScope Duo 4K's monitors to audio metering, you can also select which channels to show. The values for selecting which audio channels are mapped in the following way:

- 0: Channels 1 and 2
- 1: Channels 3 and 4
- 2: Channels 5 and 6
- 3: Channels 7 and 8
- 4: Channels 9 and 10
- 5: Channels 11 and 12
- 6: Channels 13 and 14
- 7: Channels 15 and 16

```
MONITOR B:↵  
ScopeMode: AudioDbvu↵  
AudioChannel: 0↵  
↵
```

In the example above, Monitor B has been selected to display Audio Metering in Dbvu with audio channels 1 and 2 selected for the phase meter.

Selecting LUTs for SmartView 4K

To select 3D LUTs using SmartView 4K:

```
MONITOR A:↵  
LUT: 0 LUT 1  
      1 LUT 2  
      NONE    DISABLE  
↵  
↵
```

ヘルプ

ヘルプライン

サポートを得るには4つの方法があります。

- 1 Blackmagic Designサポートセンター (www.blackmagicdesign.com/jp/support) で、最新のサポート情報を確認する。
- 2 最寄りのBlackmagic Designの取り扱い販売店に電話をかける。
- 3 最寄りの取扱販売店はBlackmagic Designから最新の技術情報を得ているので、即座にアシスタンスを提供できます。また、取扱販売店では個別のワークフロー要件に合わせたサポート計画を提供できるので、それらのサポートオプションも確認することをお勧めします。
- 4 Blackmagic Designのウェブサイト、www.blackmagicdesign.com/jp/supportで「メールを送信」ボタンを使用してメールで質問する。
- 5 Blackmagic Designサポートに電話する。サポートページの「お住まいの地域のサポートオフィス」をクリックすると、最寄りのBlackmagic Designサポートオフィスが表示されます。

ご連絡の際は、技術的な問題およびシステムの仕様を可能な限り詳しくお伝えください。できるだけ早くお返事いたします。

規制に関する警告

欧州連合内での電気機器および電子機器の廃棄処分



製品に記載されている記号は、当該の機器を他の廃棄物と共に処分してはならないことを示しています。機器を廃棄するには、必ずリサイクルのために指定の回収場所に引き渡してください。機器の廃棄において個別回収とリサイクルが行われることで、天然資源の保護につながり、健康と環境を守る方法でリサイクルが確実に行われるようになります。廃棄する機器のリサイクルのための回収場所に関しては、お住まいの地方自治体のリサイクル部門、または製品を購入した販売業者にご連絡ください。



この機器は、FCC規定の第15部に準拠し、クラスAデジタル機器の制限に適合していることが確認されています。これらの制限は、商用環境で機器を使用している場合に有害な干渉に対する妥当な保護を提供するためのものです。この機器は無線周波エネルギーを生成、使用、放出する可能性があります。また、指示に従ってインストールおよび使用しない場合、無線通信に有害な干渉を引き起こす恐れがあります。住宅地域で当製品を使用すると有害な干渉を引き起こす可能性があり、その場合はユーザーが自己責任で干渉に対処する必要があります。

動作は次の2つを条件とします：

- 1 本機は、有害な干渉を起こさない。
- 2 本機は希望しない動作を発生しかねない干渉を含む、いかなる受信干渉も受け入れる必要がある。



MSIP-REM-BMD-201410001
MSIP-REM-BMD-20150327
MSIP-REM-BMD-201702004
MSIP-REM-BMD-201702005

ISED Canadaステートメント

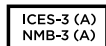

本機は、カナダのクラスAデジタル機器の規格に準拠しています。

本機のいかなる改造、あるいは目的の用途以外での使用は、これらの規格への順守を無効にすることがあります。

HDMIインターフェースへの接続は、必ず高品質のシールドHDMIケーブルを使用する必要があります。

本機は、商用環境で目的の用途に順守した使用においてテストを行なっています。非商用環境で使用された場合、無線妨害を引き起こす可能性があります。

安全情報

感電を避けるため、当製品は必ずアース端子付きコンセントに接続してください。不確かな場合は、資格を持つ電気技師に連絡してください。

感電のリスクを減らすため、水が跳ねたり、滴るような場所には置かないでください。

この製品は、周囲温度が最高40度までの熱帯地区での使用に対応しています。

通気が妨げられないように、この製品の周囲は通気に十分なスペースを開けるようにしてください。

ラックマウントする場合は、隣接する機器により通気が妨げられないようにしてください。

この製品の内部には、ユーザーが保守できる部品はありません。サービスに関しては、お近くのBlackmagic Designのサービスセンターにお問い合わせください。

一部の製品は、SFP（スモールフォームファクタ・トランシーバー）光ファイバーモジュールを接続可能。レーザークラスのクラス1のSFP光モジュールを使用。

推奨されるBlackmagic Design SFPモジュール：

- **3G-SDI**：PL-4F20-311C
- **6G-SDI**：PL-8F10-311C
- **12G-SDI**：PL-TG10-311C



海拔2000m以上では使用しないでください。

カリフォルニア州ステートメント

この製品のユーザーは、プラスチック部品内の微量の多臭素化ビフェニルなどの化学物質にさらされる可能性があります。カリフォルニア州は、多臭素化ビフェニルは発がん性があり、先天異常や生殖機能へ危害を及ぼす物質であると認識しています。

詳細は、以下のウェブサイトをご確認ください。www.P65Warnings.ca.gov

保証

12ヶ月限定保証

Blackmagic Designは、お買い上げの日から12ヶ月間、本製品の部品および仕上がりについて瑕疵がないことを保証します。この保証期間内に製品に瑕疵が見つかった場合、Blackmagic Designは弊社の裁量において部品代および人件費無料で該当製品の修理、あるいは製品の交換のいずれかに対応いたします。

この保証に基づいたサービスを受ける際、お客様は必ず保証期限終了前にBlackmagic Designに瑕疵を通知し、適応する保証サービスの手続きを行ってください。お客様の責任において不良品を梱包し、Blackmagic Designが指定するサポートセンターへ配送料前払で送付いただきますようお願い致します。理由の如何を問わず、Blackmagic Designへの製品返送のための配送料、保険、関税、税金、その他すべての費用はお客様の自己負担となります。

不適切な使用、または不十分なメンテナンスや取扱いによる不具合、故障、損傷に対しては、この保証は適用されません。Blackmagic Designはこの保証で、以下に関してサービス提供義務を負わないものとします。a) 製品のインストールや修理、サービスを行うBlackmagic Design販売代理人以外の者によって生じた損傷の修理、b) 不適切なインストールや使用、互換性のない機器への接続によって生じた損傷の修理、c) Blackmagic Designの部品や供給品ではない物を使用して生じたすべての損傷や故障の修理、d) 改造や他製品との統合により時間増加や製品の機能低下が生じた場合のサービス。この保証はBlackmagic Designが保証するもので、明示または黙示を問わず他の保証すべてに代わるものではありません。Blackmagic Designとその販売社は、商品性と特定目的に対する適合性のあらゆる黙示保証を拒否します。Blackmagic Designの不良品の修理あるいは交換の責任が、特別に、間接的、偶発的、または結果的に生じる損害に対して、Blackmagic Designあるいは販売社がそのような損害の可能性についての事前通知を得ているか否かに関わらず、お客様に提供される完全唯一の救済手段となります。Blackmagic Designはお客様による機器のあらゆる不法使用に対して責任を負いません。Blackmagic Designは本製品の使用により生じるあらゆる損害に対して責任を負いません。使用者は自己の責任において本製品を使用するものとします。

© Copyright 2020 Blackmagic Design 著作権所有、無断複写・転載を禁じます。「Blackmagic Design」、「DeckLink」、「HDLink」、「Workgroup Videohub」、「Multibridge Pro」、「Multibridge Extreme」、「Intensity」、「Leading the creative video revolution」は、米国ならびにその他諸国での登録商標です。その他の企業名ならびに製品名全てはそれぞれ関連する会社の登録商標である可能性があります。



Manuel d'utilisation et d'installation

SmartView & SmartScope

Septembre 2020

Français



Bienvenue

Nous espérons que vous partagez le même rêve que nous : c'est-à-dire que l'industrie télévisée soit un lieu créatif qui permette à chacun d'avoir accès à la plus haute qualité vidéo qui soit.

Le monitoring vidéo est nécessaire dans tous les studios. Le SmartView 4K est doté d'un écran LCD 4K natif, vous pouvez ainsi visionner de la vidéo Ultra HD en pleine résolution. De plus, son boîtier de 6 unités de rack comprend un panneau de contrôle qui permet de modifier rapidement les paramètres. Le SmartView HD offre quant à lui un écran LCD de 17 pouces, dans un design de 6 unités de rack et de moins d'un pouce d'épaisseur. Le SmartView Duo intègre deux écrans LCD indépendants de 8 pouces dans un format de 3 unités de rack et de moins d'un pouce d'épaisseur. Enfin, le SmartScope Duo 4K comprend deux écrans LCD indépendants de 8 pouces ainsi qu'une fonction d'affichage de la forme d'onde, vous pouvez donc vérifier les niveaux de votre vidéo à la volée. Tous les moniteurs SmartView prennent en charge la vidéo SD, HD et 2K via 3G-SDI. Le SmartScope Duo 4K et le SmartView 4K supportent même l'Ultra HD 4K via 6G-SDI et 12G-SDI respectivement !

Ces solutions de monitoring vidéo ont été conçues pour fonctionner dès leur sortie de l'emballage. De plus, le logiciel Blackmagic SmartView Setup offre aux utilisateurs un outil de configuration simple et intuitif.

Ce manuel d'utilisation devrait contenir toutes les informations dont vous avez besoin pour la mise en route de votre SmartView ou SmartScope. Il vous est toutefois recommandé de faire appel à du personnel qualifié en cas de doute sur ce qu'est une adresse IP ou si vous souhaitez davantage d'informations sur les réseaux d'ordinateurs. Les produits SmartView et SmartScope sont faciles à installer. Il y a toutefois quelques préférences techniques qu'il vous faudra configurer après l'installation.

L'installation devrait vous prendre 5 minutes. Veuillez consulter notre site Internet www.blackmagicdesign.com/fr et notre page d'assistance pour télécharger les dernières mises à jour de ce manuel et du logiciel SmartView. Enfin, veuillez enregistrer votre équipement lors du téléchargement des mises à jour afin que nous puissions vous tenir informés de la sortie d'un nouveau logiciel. Nous travaillons constamment sur de nouvelles fonctionnalités et nous nous efforçons d'améliorer nos services en permanence : c'est pourquoi nous aimerions avoir votre avis !

Grant Petty

PDG de Blackmagic Design

Sommaire

SmartView & SmartScope

Mise en route	85
Découverte du SmartView et du SmartScope	85
Connecter des sources vidéo	86
Connecter un ordinateur	86
Installer le Blackmagic SmartView Setup	87
Utiliser le Blackmagic SmartView Setup	88
Mise à jour du logiciel	88
Ajuster les paramètres du moniteur	88
Case Enable tally override	91
Utiliser le SmartView 4K	91
Découvrir le Blackmagic SmartView 4K	91
Boutons de contrôle	92
Charger des LUTs 3D à l'aide du Blackmagic SmartView Setup	94
Utiliser SmartScope Duo 4K	95
Qu'est-ce que le Blackmagic SmartScope ?	95
Affichage Video Monitoring	96
Affichage Waveform	97
Affichage Vectorscope	98
Affichages Parade	99
Affichage Histogram	101
Affichages des niveaux audio	102
Connexion à un réseau	103
Connexion Ethernet directe	103
Commutateur réseau Ethernet	104
Modifier les paramètres réseau	105
Paramètres réseau	105
Ajouter un moniteur Blackmagic	107
Utilisation du tally	108
Broches du port tally	108
Optimiser l'angle de vision	109
Developer Information	111
Blackmagic 2K Format – Overview	111
Blackmagic 2K Format – Vertical Timing Reference	112
Blackmagic 2K Format – Data Stream Format	113
Blackmagic SmartView Ethernet Protocol v1.3	114
Assistance	118
Avertissements	119
Informations de sécurité	120
Garantie	121

Mise en route

Découverte du SmartView et du SmartScope

Les moniteurs SmartView sont des outils de choix pour les studios qui ont besoin d'une solution de monitoring sur rack. Pour les mettre en route, il suffit de les brancher à une source d'alimentation et de connecter une source SDI !

Le SmartView 4K possède un écran LCD 4K de 15,6 pouces, vous pouvez donc afficher de la vidéo SD, HD ou Ultra HD dans sa résolution native de 3840x2160. Les boutons situés sur la face avant de l'appareil vous permettent de sélectionner facilement les entrées, d'ajuster la luminosité de l'écran, de vérifier s'il y a du bruit dans le canal bleu, d'afficher les informations de blanking, d'appliquer des LUTs 3D et autres.

Le SmartView HD intègre un écran LCD HD de 17 pouces qui est parfait pour le monitoring en HD pleine résolution.

Le SmartView Duo dispose de deux moniteurs pour afficher simultanément différents signaux vidéo. Vous pouvez par exemple afficher un signal YUV 4:2:2 sur le premier moniteur et un signal RVB 4:4:4 sur le deuxième, ou encore un signal NTSC sur un moniteur et un signal PAL sur l'autre. Réalisez de nombreuses combinaisons, en connectant simplement un câble SDI à chaque moniteur !

SmartScope Duo 4K intègre les mêmes fonctionnalités que SmartView Duo, mais il permet également d'afficher la forme d'onde, le vecteurscope et d'autres scopes populaires pour le monitoring de la vidéo et de l'audio en temps réel. De plus, vous disposez d'une prise en charge intégrale de l'Ultra HD 4K !

Toutes les entrées SDI des moniteurs SmartView et SmartScope supportent la détection automatique de la SD, de la HD ou du 3G-SDI, y compris la vidéo 2K. Le SmartView 4K détecte également l'Ultra HD via 12G-SDI, notamment les formats tels que 2160p60. Le SmartScope Duo 4K, quant à lui, détecte automatiquement la vidéo Ultra HD 4K via 6G-SDI.

Si vous souhaitez ajuster à distance les paramètres de plusieurs appareils SmartView et SmartScope à partir d'un ordinateur, vous pouvez les relier ensemble via Ethernet. Ainsi, vous n'aurez pas besoin de brancher un ordinateur à chaque appareil via USB à chaque fois que vous devez ajuster des paramètres.

C'est tout ce que vous devez savoir pour commencer ! Veuillez lire ce qui suit pour obtenir de plus amples informations concernant la connexion du SmartView et du SmartScope, la configuration des paramètres du moniteur à l'aide du Blackmagic SmartView Setup et la connexion à un réseau.



SmartView 4K



SmartView HD



SmartView Duo



SmartScope Duo 4K

Connecter des sources vidéo

Les moniteurs SmartView et SmartScope intègrent des connecteurs BNC standard pour connecter des équipements SDI, tels que des mélangeurs, des caméras, des cartes d'acquisition et des enregistreurs.

Afficher une image

Afficher une image est un jeu d'enfant ! Il suffit de mettre l'appareil en marche et de connecter une source vidéo à une entrée SDI. Une fois l'appareil alimenté et connecté, la vidéo devrait s'afficher immédiatement. Les signaux SD, HD et 2K sont détectés automatiquement par l'entrée et la sortie en boucle SDI. Le SmartView 4K et le SmartScope Duo 4K détectent également l'Ultra HD 4K.

Lorsque l'appareil ne reçoit pas de vidéo, le rétro-éclairage s'éteint afin d'économiser de l'énergie jusqu'à ce qu'un signal valide soit reçu.

Relier les moniteurs en chaîne

Chaque moniteur SmartView et SmartScope possède sa propre entrée SDI indépendante ainsi qu'une sortie en boucle afin que vous puissiez relier plusieurs moniteurs en chaîne pour afficher le même signal d'entrée :

- 1 Alimentez l'appareil 1. Connectez une source vidéo à une entrée SDI. La vidéo devrait s'afficher immédiatement.
- 2 Alimentez l'appareil 2. Connectez un câble SDI entre la sortie en boucle de l'appareil 1 et l'entrée SDI de l'appareil 2.

Il n'y a pas de limite au nombre d'appareils que vous pouvez relier.

Si vous faites du monitoring de forme d'onde avec le SmartScope Duo 4K, vous souhaiterez sans doute relier la sortie du moniteur 1 au moniteur 2 afin que les deux écrans affichent le même signal d'entrée.

Une fois la vidéo affichée, vous pouvez ajuster les paramètres des moniteurs, ou sélectionner des scopes sur le SmartScope Duo 4K à l'aide du logiciel SmartView Setup. Vous pouvez également utiliser ce logiciel pour charger des LUTs 3D sur le Blackmagic SmartView 4K.



Connecter un ordinateur

Configurez les paramètres du moniteur SmartView ou SmartScope en le connectant à votre ordinateur via USB et en installant le logiciel Blackmagic SmartView Setup.

La connexion USB permet également d'effectuer des mises à jour logicielles téléchargées sur le site Internet de Blackmagic Design. Ces mises à jour peuvent offrir de nouvelles fonctionnalités, une compatibilité avec du nouveau matériel ou une prise en charge de nouveaux formats. Le logiciel Blackmagic SmartView Setup peut être installé sur les ordinateurs macOS et Windows.

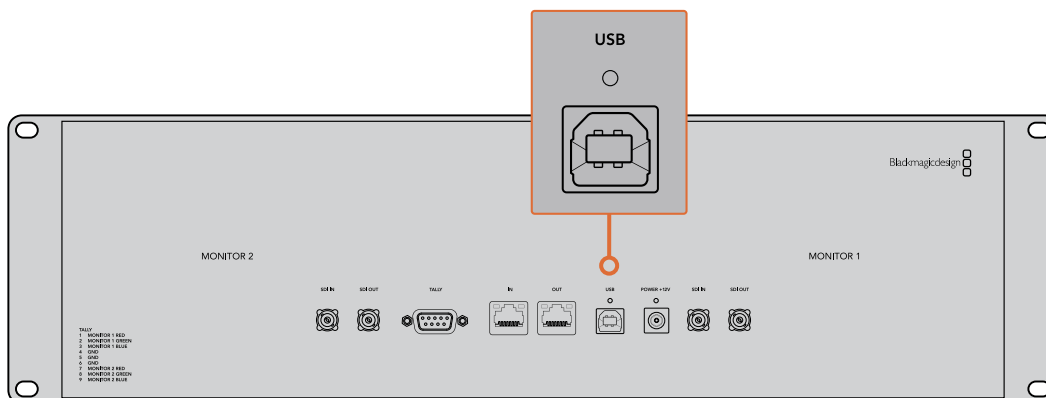

Installer le Blackmagic SmartView Setup

Le Blackmagic SmartView Setup est compatible avec les dernières versions Sierra et High Sierra de macOS, et avec les versions 64 bits de Windows 8.1 et Windows 10 si les derniers service pack sont installés. Si vous le souhaitez, le Blackmagic SmartView Setup peut être installé sur plusieurs ordinateurs en réseau.

La carte SD fournie avec le SmartView contient le programme d'installation du logiciel. Toutefois, nous vous conseillons de consulter le site www.blackmagicdesign.com/fr/support pour vous assurer que vous disposez de la dernière version.

Installation sur macOS :

Ouvrez la carte SD fournie, ou l'image disque téléchargée, et double-cliquez sur l'icône d'installation SmartView. Un dossier SmartView sera créé dans le dossier Applications. Il contiendra le logiciel SmartView Setup, un désinstalleur pour supprimer les anciennes versions lors des mises à jour, et un dossier documents contenant ce manuel et d'autres informations relatives à SmartView.

Installation sur Windows :

Sur Windows, ouvrez la carte SD qui vous a été fournie, ou le fichier zip téléchargé, et double-cliquez sur le programme d'installation SmartView. Suivez les instructions à l'écran pour installer le logiciel.

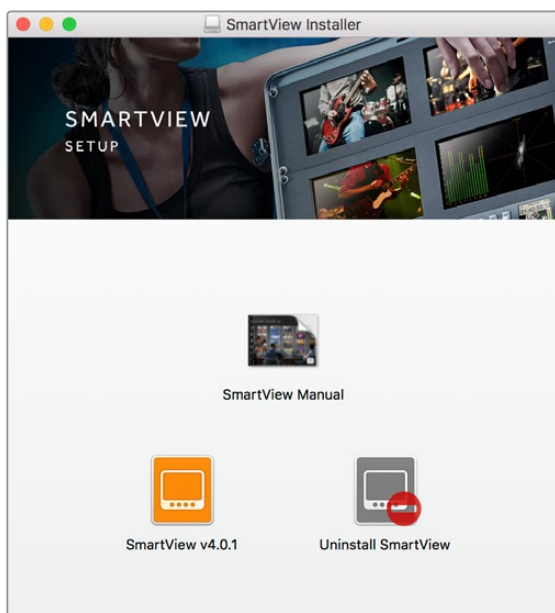

Pour installer le logiciel sur macOS, ouvrez le fichier SmartView.dmg sur la carte SD fournie, ou dans le dossier Downloads, puis double-cliquez sur l'icône d'installation SmartView.

Utiliser le Blackmagic SmartView Setup

Mise à jour du logiciel

Une fois que vous avez installé et ouvert le SmartView Setup, cliquez sur l'icône de paramétrage située sous le nom du moniteur. Une mise à jour du logiciel interne de votre SmartView ou SmartScope vous sera peut-être proposée. Pour ce faire :

- 1 Connectez votre SmartView ou SmartScope à un ordinateur via USB ou Ethernet, puis ouvrez le Blackmagic SmartView Setup.
- 2 Lorsque le message s'affiche, cliquez sur **Update**. La mise à jour peut prendre quelques minutes.
- 3 Le message : "This SmartView has been updated" (Ce SmartView a été mis à jour) devrait s'afficher à l'écran une fois la mise à jour effectuée.
- 4 Cliquez sur **Close**.

Si aucune mise à jour logicielle n'est requise, le Blackmagic SmartView Setup ouvrira la page de configuration de votre moniteur.

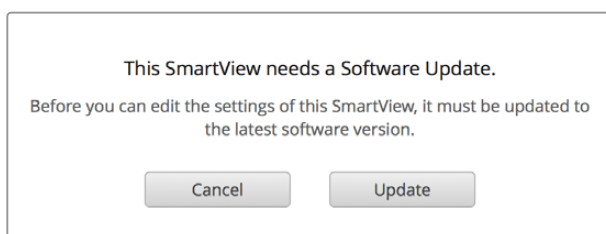

Lorsque vous lancez le SmartView Setup et que vous cliquez sur l'icône de paramétrage du SmartView ou SmartScope connecté, ce message apparaît si une mise à jour est requise.

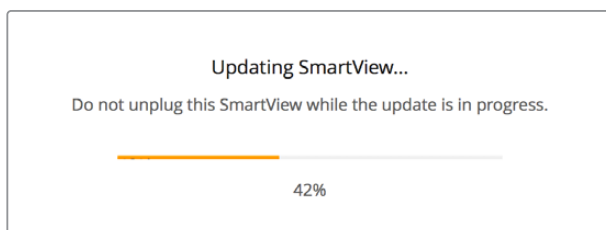

La mise à jour prendra environ 5 minutes.

Ajuster les paramètres du moniteur

Une fois ouvert, l'utilitaire Blackmagic SmartView Setup cherche automatiquement les appareils SmartView ou SmartScope connectés via USB ou Ethernet, et les affiche sur la page d'accueil du SmartView Setup. Si plusieurs moniteurs Blackmagic sont connectés à votre réseau, cliquez sur les flèches situées sur les côtés gauche et droit de la page d'accueil pour sélectionner le moniteur que vous souhaitez ajuster. Si votre moniteur Blackmagic est connecté via USB, une icône USB apparaîtra à côté du nom du moniteur.

Pour ajuster des paramètres, sélectionnez le moniteur connecté via Ethernet ou USB, et cliquez sur l'icône de paramétrage située sous le nom du moniteur. La page de configuration du moniteur sélectionné s'ouvrira. Une fois que vous êtes satisfait des nouveaux paramètres, cliquez sur le bouton **Save** afin de sauvegarder les paramètres et de retourner sur la page d'accueil du SmartView Setup.

Consultez la section suivante pour obtenir plus d'informations concernant le réglage des paramètres des moniteurs Blackmagic. Pour obtenir plus d'informations sur la configuration des paramètres réseau à l'aide du Blackmagic SmartView Setup, consultez la section « Ajuster les paramètres réseau » de ce manuel.

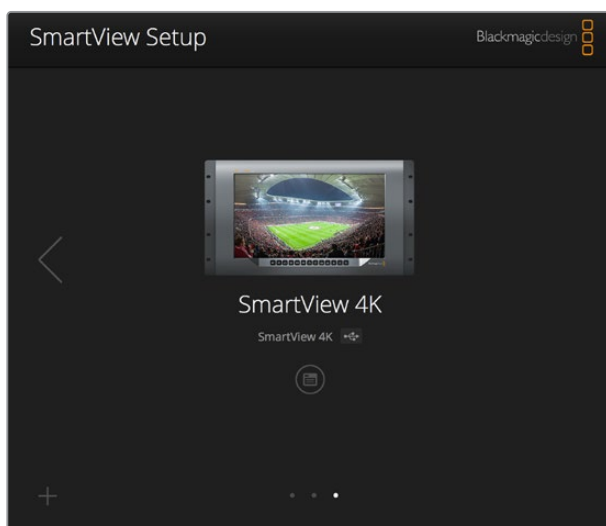

Le logiciel Blackmagic SmartView Setup recherche automatiquement les appareils SmartView et SmartScope connectés localement via USB ou sur un réseau. Lorsque vous mettez à jour le logiciel interne du moniteur, veillez à ce que le moniteur soit connecté via USB ou Ethernet. Une icône USB apparaîtra à côté du nom du moniteur.

Paramètres du moniteur

Pour ajuster les paramètres et les affichages de chaque moniteur, il faut les connecter via Ethernet ou USB. Sélectionnez le moniteur que vous souhaitez régler en cliquant sur les flèches gauche et droite de la page d'accueil du SmartView Setup, puis cliquez sur l'icône de paramétrage située sous le nom du moniteur. La page de configuration est automatiquement personnalisée afin de correspondre aux fonctionnalités offertes par le moniteur Blackmagic sélectionné.

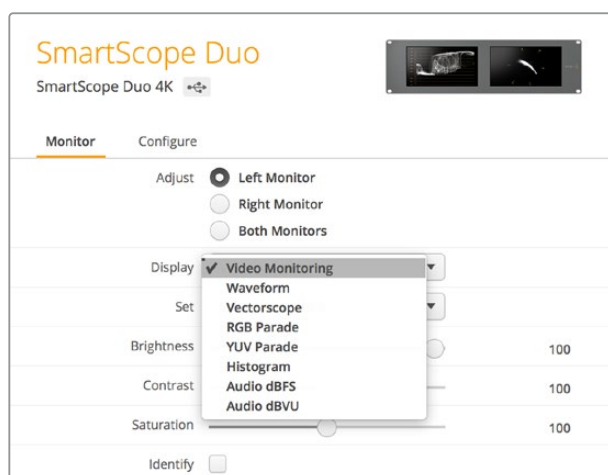

Sur SmartScope, vous pouvez choisir entre les scopes et le monitoring vidéo dans le menu déroulant **Display**.

Paramètre Adjust

Lorsque vous utilisez un SmartScope ou un SmartView Duo, choisissez le(s) moniteur(s) que vous souhaitez ajuster en sélectionnant **Left Monitor**, **Right Monitor** ou **Both Monitors**. Lorsque le paramètre **Both Monitors** est activé, les ajustements de luminosité, de contraste et de saturation seront appliqués aux deux moniteurs de SmartView Duo et de SmartScope.

Paramètre Display

Lorsque vous utilisez un SmartScope, le menu déroulant **Display** vous permet de sélectionner les scopes. Sélectionnez **Video Monitoring** si vous souhaitez uniquement afficher l'image vidéo.

Paramètre Set

Sur le SmartScope, le menu déroulant **Set** vous permet de sélectionner un format 4:3 ou 16:9 pour le monitoring vidéo lorsque vous travaillez avec de la vidéo SD. Le menu déroulant **Set** offre des options supplémentaires pour l'affichage sélectionné, notamment vecteurscope, audio dBFS et audio dBVU.

- **Video Monitoring** : Choisissez d'afficher l'image vidéo au format 4:3 ou 16:9. Pour visionner de la vidéo SD au format large anamorphosé, choisissez 16:9. En revanche, pour visionner de la vidéo SD standard, choisissez 4:3.
- **Vectorscope** : Choisissez si votre entrée repose sur une mire de barres couleurs de 100% ou de 75%.
- **Audio dBFS** : Choisissez la paire de canaux audio pour le monitoring de la phase.
- **Audio dBVU** : Choisissez la paire de canaux audio pour le monitoring de la phase.

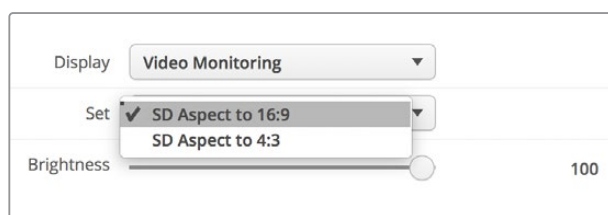

Pour visionner de la vidéo SD au format large anamorphosé, choisissez **SD Aspect to 16:9**.

Paramètres Brightness, Contrast, Saturation

Déplacez les curseurs pour ajuster la luminosité, le contraste et la saturation. Les paramètres disponibles varient selon les modèles SmartView et SmartScope.

Case Identify

Lorsque la case **Identify** est cochée, les moniteurs sélectionnés dans le Blackmagic SmartView Setup afficheront une bordure blanche. Lorsque plusieurs appareils SmartView et SmartScope sont connectés sur un réseau, ce paramètre permet d'identifier facilement le moniteur sélectionné.

Lorsque ce paramètre est utilisé conjointement avec le paramètre **Both Monitors**, la bordure blanche s'affichera sur les deux moniteurs de SmartView Duo ou de SmartScope Duo 4K.

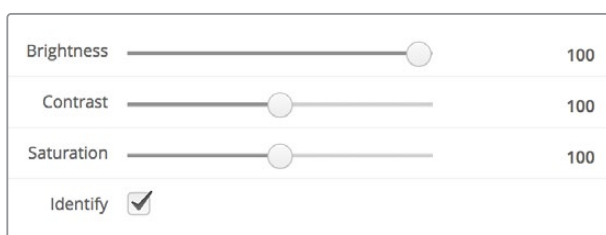

Déplacez les curseurs vers la gauche ou vers la droite pour ajuster la luminosité, le contraste et la saturation. Cochez la case **Identify** pour identifier le moniteur sélectionné.

Case Enable tally override

Cochez la case **Enable tally override** pour activer les bordures tally sur le Blackmagic SmartView 4K. Cette fonction est compatible avec la Blackmagic URSA Mini Pro 4.6K et la Blackmagic URSA Broadcast.

Connectez la sortie SDI de la caméra à l'entrée A ou B de votre SmartView 4K.

Connectez la sortie programme du mélangeur ATEM à l'entrée SDI de la caméra.

Lorsque le mélangeur ATEM commute la caméra sur la sortie programme, une bordure tally rouge apparaît sur le SmartView 4K. Lorsqu'elle est commutée sur la sortie prévisualisation, la bordure tally est verte.

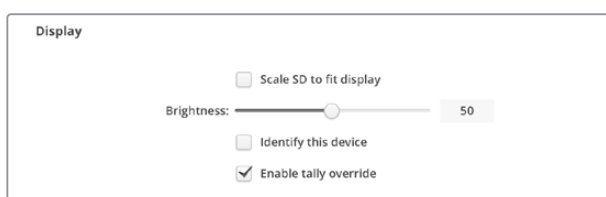

Cochez la case **Enable tally override** pour afficher les bordures tally sur le SmartView 4K lorsqu'il est connecté à une caméra Blackmagic URSA Mini Pro ou URSA Broadcast.

Utiliser le SmartView 4K

Découvrir le Blackmagic SmartView 4K

Le SmartView 4K est un moniteur broadcast Ultra HD de 6 unités de rack, doté de connexions 12G-SDI permettant un affichage de la vidéo SD, HD et Ultra HD jusqu'à 2160p60. Avec son écran lumineux et son large angle de vision, le SmartView 4K offre une image nette aux couleurs vives pour une mise au point et un monitoring des couleurs précis. De plus, il prend en charge la plupart des formats vidéo.

Conçu pour une utilisation en studio et en extérieur, le SmartView 4K offre une excellente prise en main. Grâce à ses connexions sur la face latérale et sa prise en charge des normes VESA, l'appareil peut être installé dans des espaces restreints, sur un mur ou sur un bras articulé. Le SmartView 4K peut être contrôlé à l'aide du panneau de commande intégré, ou à distance via Ethernet lorsque le panneau avant n'est pas accessible.

Les deux entrées 12G-SDI multidébits vous permettent de choisir entre deux sources SDI, et grâce au logement pour module SFP conforme aux normes SMPTE, vous pouvez ajouter un module SDI fibre optique et connecter votre vidéo via fibre optique. Le SmartView 4K intègre également une sortie 12G-SDI pour acheminer votre vidéo vers d'autres équipements, deux connecteurs Ethernet pour la connexion en réseau, le contrôle à distance et une sortie en boucle permettant une liaison en cascade avec d'autres moniteurs. De plus, il est doté d'une entrée tally pour la production en direct et d'un port USB pour les mises à jour du logiciel interne.

Vous pouvez même charger des LUTs 3D conformes aux normes de l'industrie avec l'extension .cube ou des LUTs DaVinci Resolve à l'aide du Blackmagic SmartView Setup. En outre, les LUTs 3D vous permettent de connecter le SmartView 4K directement à la caméra et de visionner vos clips juste avant l'étalonnage final. Grâce aux deux niveaux de focus peaking, la mise au point de vos plans sera toujours impeccable. De plus, la prise en charge du courant alternatif et du courant continu vous permet de brancher l'appareil à une prise secteur ou à une batterie externe pour vous déplacer sur le plateau.

Le SmartView 4K est la solution de monitoring idéale pour la production broadcast en extérieur et en studio, car il affiche la vidéo en SD, HD et Ultra HD dans sa résolution native de 3840x2160.



REMARQUE Lorsque vous connectez l'alimentation externe via l'entrée d'alimentation DC, veillez à ce que la sortie d'alimentation externe puisse prendre en charge 24 watts à 12 volts.

Boutons de contrôle

Le panneau de contrôle intègre une rangée de boutons pour ajuster rapidement les paramètres du SmartView 4K.

Bouton Input

Appuyez sur ce bouton pour passer en revue tous les signaux vidéo connectés aux entrées 12G-SDI du SmartView 4K et à l'entrée du module SFP fibre optique en option. Lorsqu'aucune vidéo n'est connectée, l'entrée en question affiche un signal noir. Lorsque vous commutez entre les entrées, des informations concernant le format de l'entrée connectée s'affichent momentanément en haut à gauche du moniteur.

Bouton Disp

Le bouton **Disp** permet de régler la luminosité de l'écran LCD du SmartView 4K. Ajustez la luminosité en appuyant sur les flèches haute et basse. Appuyez à nouveau sur le bouton **Disp** pour fermer ce paramètre.

Bouton H/V Delay

Le bouton **H/V Delay** vous permet de confirmer rapidement la présence de données auxiliaires au sein du signal vidéo SDI. Par exemple, appuyez une fois sur le bouton H/V Delay pour visualiser les données auxiliaires horizontales. Appuyez à nouveau sur ce bouton pour afficher les données auxiliaires verticales, utilisées couramment pour le sous-titrage codé.

Bouton Blue Only

Si le signal vidéo numérique comporte du bruit, celui-ci est plus visible au sein du canal bleu. Vous pouvez donc facilement vérifier si le signal est bruité en appuyant sur le bouton **Blue Only**. Cette fonction affiche uniquement le canal bleu, représenté par une image en noir et blanc. Cette image en noir et blanc peut également être utilisée lorsque vous vérifiez la mise au point de la caméra.

Bouton Zoom

Une façon d'obtenir une mise au point impeccable sur la caméra est d'utiliser le bouton **Zoom**. Appuyez une fois pour zoomer dans l'image. Vous pouvez ainsi facilement voir si un objet est net. Appuyez une nouvelle fois pour rétablir l'image.

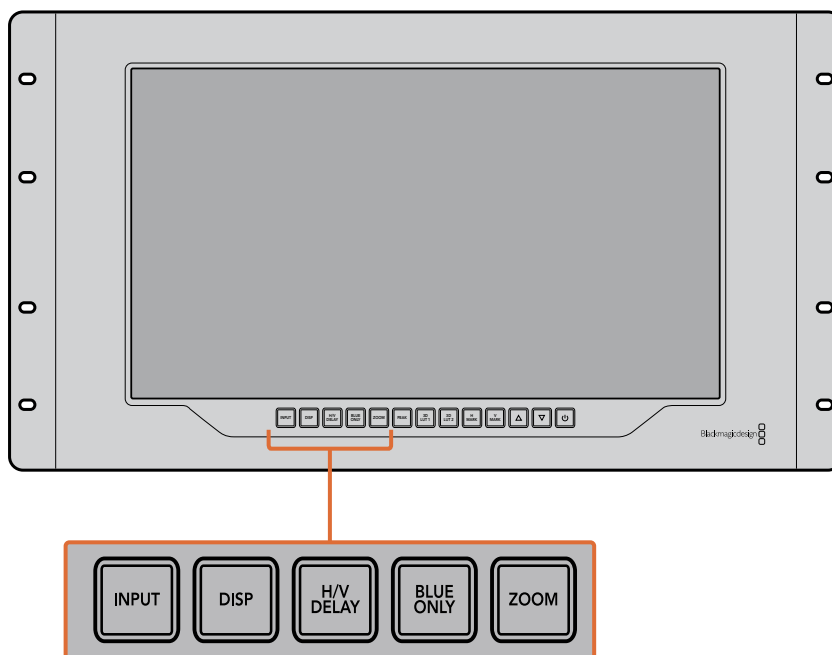

Bouton Peak

Appuyez sur le bouton **Peak** pour activer le focus peaking afin de vérifier facilement la mise au point de la caméra. Cette fonction affiche un contour vert autour des zones les plus nettes de l'image. Vous pouvez commuter entre deux niveaux de peaking en appuyant plusieurs fois sur ce bouton. Des contours verts très prononcés indiquent que l'image de la caméra est nette.

3D LUT 1 et 3D LUT 2

Les boutons LUT vous permettent de visualiser votre image à l'aide de LUTs 3D personnalisées générées dans DaVinci Resolve ou de LUTs .cube conformes aux normes de l'industrie. Appuyez sur un des boutons LUT pour activer la LUT en question. Touchez à nouveau pour la désactiver. Pour plus d'informations sur l'utilisation des LUTs 3D avec le SmartView 4K, consultez la section « Charger des LUTs 3D à l'aide du Blackmagic SmartView Setup ».

Boutons H Mark et V Mark

Vous pouvez visualiser et modifier les repères d'image à l'aide des boutons **H Mark** et **V Mark**. Les repères d'image facilitent la composition des plans et vous permettent de positionner des informations importantes ou des graphiques au sein de la zone de sécurité de l'écran. Comme la bordure du signal vidéo affichée à l'écran varie selon le téléviseur, il est donc utile de pouvoir visualiser la zone de sécurité. La zone de sécurité est la zone de l'écran qui est toujours visible, quel que soit le téléviseur ou le moniteur utilisé.

Pour afficher les repères d'image horizontaux et verticaux, appuyez sur les boutons **H Mark** et **V Mark** respectivement. Pour modifier les repères, appuyez à nouveau sur les mêmes boutons afin d'afficher les repères en surbrillance. Vous pourrez ainsi modifier la position des repères à l'aide des flèches haut et bas. Confirmez la nouvelle position des repères en appuyant à nouveau sur les mêmes boutons. Réappuyer une nouvelle fois sur ces boutons désactive les repères.

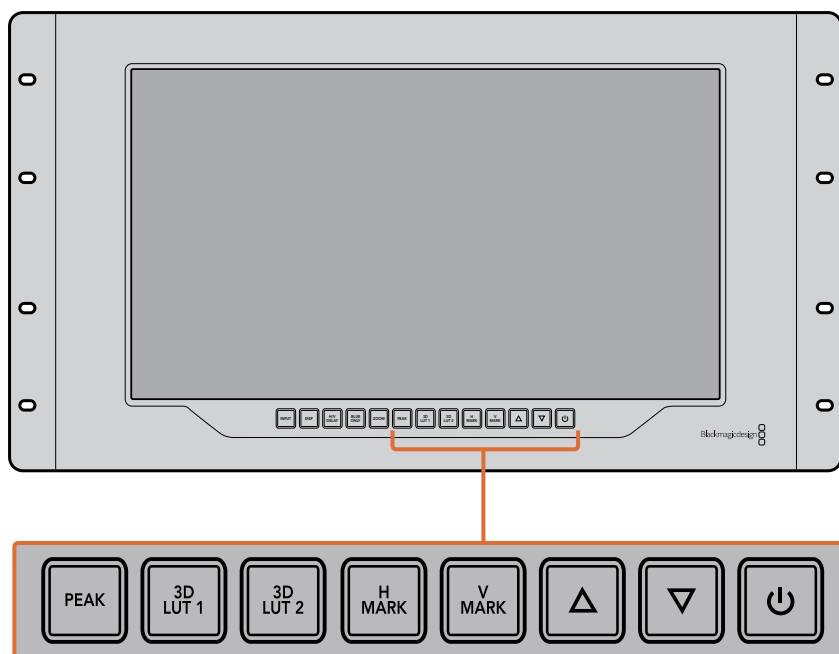

Flèches haut et bas

Utilisez les flèches haut et bas pour modifier un paramètre, par exemple pour ajuster la luminosité de l'écran ou la position des repères d'image.

Bouton de mise en marche

Appuyez une fois sur le bouton de mise en marche pour allumer le SmartView 4K. Appuyez à nouveau sur le même bouton pour l'éteindre.

Charger des LUTs 3D à l'aide du Blackmagic SmartView Setup

Le SmartView 4K vous permet de visualiser votre vidéo à l'aide de LUTs 3D. Ainsi, vous pouvez calibrer le SmartView 4K à l'aide de LUTs d'étalonnage professionnelles, ou visualiser la vidéo juste avant l'étalonnage final. Il est également possible d'utiliser les LUTs 3D pour créer différents rendus. Les LUTs sont chargées dans le SmartView 4K à l'aide du Blackmagic SmartView Setup, et comme le SmartView 4K prend en charge les fichiers LUT conformes aux normes de l'industrie dotés d'une extension .cube, vous pouvez même charger des LUTs personnalisées créées sur Blackmagic DaVinci Resolve. Veuillez consulter le manuel DaVinci Resolve pour obtenir de plus amples informations sur la création de fichiers LUT.

Charger une LUT 3D dans le 3D LUT 1 :

- 1 Ouvrez le Blackmagic SmartView Setup.
- 2 Appuyez sur le bouton **Load LUT 1**. Une fenêtre s'ouvre pour vous demander quel est l'emplacement du fichier LUT que vous souhaitez charger. Sélectionnez le fichier LUT .cube désiré, puis appuyez sur le bouton **Open**.
- 3 Pour visualiser la LUT que vous venez de charger, appuyez sur le bouton 3D LUT 1 du panneau de contrôle du SmartView 4K. Appuyez à nouveau sur ce bouton pour désactiver la LUT.

Suivez la même procédure pour charger un fichier LUT dans le 3D LUT 2.

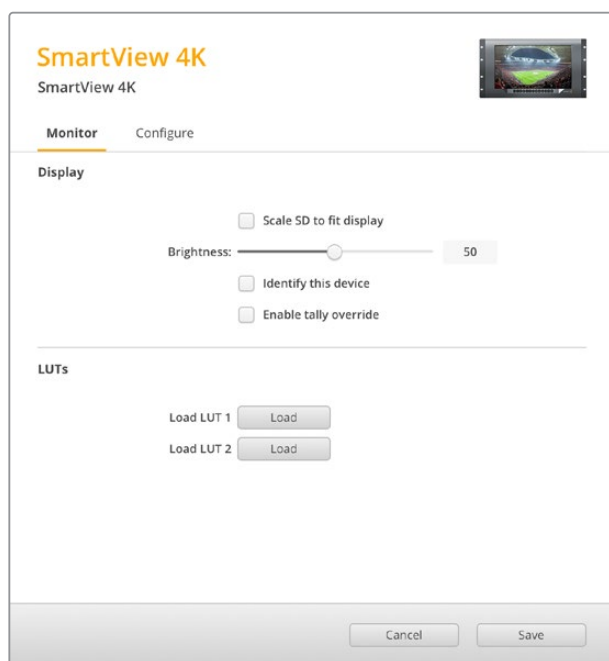

Utilisez le Blackmagic SmartView Setup pour charger des LUTs 3D sur le SmartView 4K.

Utiliser SmartScope Duo 4K

Qu'est-ce que le Blackmagic SmartScope ?

Dans le passé, les scopes de télédiffusion et de postproduction coûtaient extrêmement cher et étaient peu pratiques, car on ne pouvait visualiser qu'un seul scope à la fois sur un écran minuscule. Certains scopes sont inesthétiques et il est donc préférable qu'ils ne soient pas visibles.

Grâce au SmartScope Duo 4K, vous disposez de moniteurs de forme d'onde qui vous permettent d'afficher tous les aspects de votre signal vidéo sur deux moniteurs en temps réel. Tous les ajustements apportés au signal d'entrée à l'aide du Blackmagic SmartView Setup sont immédiatement visibles sur le SmartScope Duo 4K. De plus, chaque signal d'entrée peut être envoyé sur le moniteur de votre choix via la sortie en boucle SDI. Vous pouvez ainsi utiliser le moniteur de droite pour afficher le scope du signal reçu par le moniteur de gauche.

Les scopes affichés sur le SmartScope Duo 4K sont sélectionnés dans le logiciel Blackmagic SmartView Setup. Choisissez le scope désiré dans le menu déroulant **Display**.

Consultez les pages suivantes pour obtenir des informations concernant l'utilisation de chaque scope afin que vous puissiez mieux comprendre l'aide qu'il peut vous apporter.

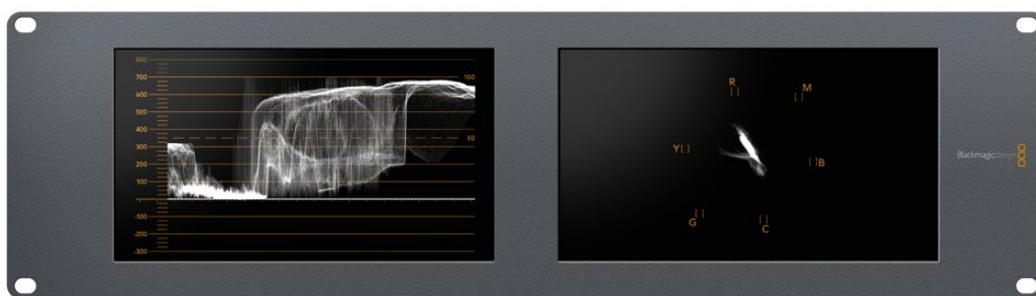

Il est facile de régler le Blackmagic SmartScope Duo 4K à l'aide du Blackmagic SmartView Setup pour qu'il affiche un scope différent sur chaque moniteur.

Affichage Video Monitoring

L'affichage Video Monitoring est un écran de contrôle très pratique qui vous permet de visualiser la vidéo reçue par SmartScope.

Si votre signal d'entrée est en SD, vous pouvez choisir entre un affichage 4:3 pillarbox ou 16:9 à partir du menu déroulant **Set**. Tous les changements apportés aux paramètres de luminosité, de contraste et de saturation de l'écran LCD sont immédiatement visibles sur cet affichage. Notez toutefois que ces changements n'affectent que le moniteur. Comme le signal vidéo reste inchangé, les scopes ne seront pas affectés par les ajustements de saturation et de luminosité.

Il est souvent utile de régler un moniteur sur **Video Monitoring** et l'autre sur un scope de votre choix. Pour ce faire, utilisez un petit câble pour connecter la sortie en boucle SDI du moniteur 1 à l'entrée SDI du moniteur 2.

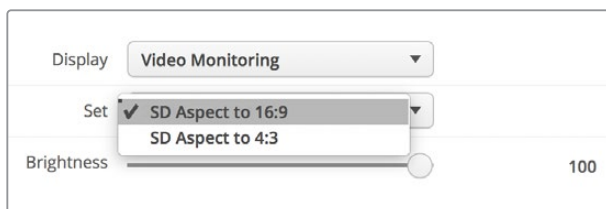

Vous pouvez visualiser la vidéo SD au format 4:3 pillarbox ou 16:9 écran large à partir de l'option **Set** du Blackmagic SmartView Setup. Pour visionner de la vidéo SD au format large anamorphosé, choisissez **SD Aspect to 16:9**.

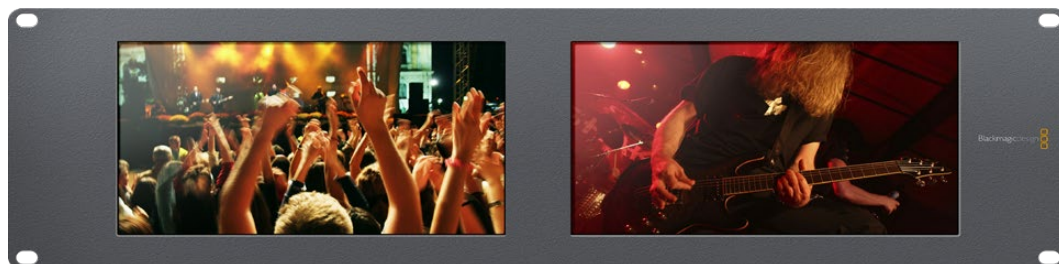

L'affichage **Video Monitoring** affiche le signal vidéo tel qu'il apparaîtrait sur un téléviseur ou un moniteur.

Affichage Waveform

L'affichage Waveform affiche une forme d'onde encodée numériquement qui ressemble à celle des moniteurs de forme d'onde traditionnels. Il est utilisé pour contrôler et ajuster les niveaux de luminance (luminosité) du signal vidéo.

Les moniteurs de forme d'onde traditionnels ne prennent en charge que la vidéo analogique composite en définition standard. Toutefois, l'affichage Waveform du SmartScope Duo 4K prend également en charge la HD et l'Ultra HD. Vous disposez ainsi d'un moyen aisé d'ajuster les niveaux de luminance, même lorsque vous faites du monitoring sur des formats vidéo numériques en haute définition.

Sélectionnez **Waveform** dans le menu déroulant **Display** du Blackmagic SmartView Setup. Veillez à ce que le niveau des noirs de votre forme d'onde ne descende pas en dessous de 0% et que le niveau des blancs ne dépasse pas 100%, ce qui représenterait des valeurs de luminance illégales.

L'affichage de la forme d'onde est une représentation graphique de l'image. Elle indique la valeur de luminance correspondante à son emplacement dans l'image. Par exemple, si une zone du ciel est surexposée, vous le verrez au même emplacement horizontal sur la forme d'onde que dans l'image.

La forme d'onde apparaîtra différemment selon votre séquence. Si vous travaillez sur une vidéo avec un fort contraste, vous ne verrez aucune valeur dans les tons moyens. L'image ci-dessous affiche la forme d'onde d'une image bien exposée. Elle comprend une zone foncée à gauche, et des zones plus claires à partir du centre de l'image jusqu'à sa droite.

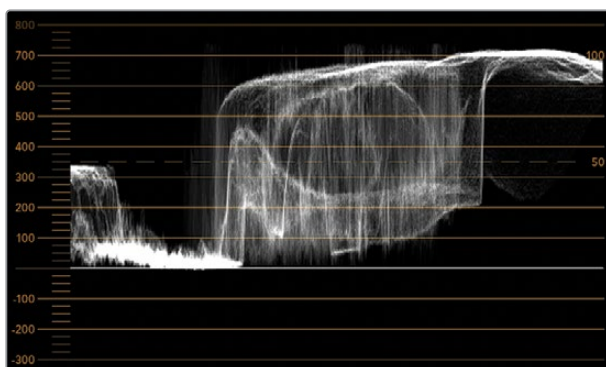

L'affichage Waveform montre les valeurs de luminance.

Adjust	<input checked="" type="radio"/> Left Monitor
	<input type="radio"/> Right Monitor
	<input type="radio"/> Both Monitors
Display	Waveform ▼
Set	No Options ▼

Sélectionnez **Waveform** dans les paramètres **Display** du Blackmagic SmartView Setup pour afficher les valeurs de luminance du signal vidéo.

Affichage Vectorscope

Le vecteurscope utilise un vecteur pour indiquer les couleurs présentes dans le signal vidéo. Selon la norme de la mire de barres couleurs utilisée, sélectionnez 100% ou 75% dans le menu déroulant **Set** du Blackmagic SmartView Setup.

Certains pensent qu'il est possible d'utiliser un vecteurscope pour vérifier s'il y a des niveaux illégaux. En fait, c'est une idée fautive car c'est l'affichage Parade RGB qui permet de vérifier s'il y a des couleurs illégales. La raison pour laquelle vous ne pouvez pas utiliser un vecteurscope pour vérifier la présence de niveaux illégaux est que cela nécessite des valeurs de luminance et chromatiques. Par exemple, les couleurs dont la saturation est très basse ou très haute deviennent illégales beaucoup plus rapidement que les tons moyens. Comme l'affichage Vectorscope ne montre que les couleurs et n'indique pas les valeurs de luminance, il ne peut pas être utilisé pour vérifier s'il y a des couleurs illégales.

L'affichage Vectorscope est le meilleur outil pour contrôler les niveaux de couleur des anciennes bandes vidéo analogiques où il est nécessaire d'ajuster les niveaux chromatiques. Faites simplement une lecture du segment de la bande vidéo qui représente la mire et ajustez ensuite les paramètres Chroma et Hue (teinte) afin de régler les couleurs de la vidéo dans les carrés sur la graticule.

L'affichage Vectorscope est parfait pour l'étalonnage, car il vous permet de voir aisément si la balance des blancs de votre vidéo est correcte ou si la vidéo est teintée. Lorsque la vidéo est teintée, l'affichage Vectorscope est décentré, et il se peut que deux points centraux s'affichent. Normalement, le blanking du signal vidéo crée un point au centre du vecteurscope, car il représente une zone noire du signal vidéo. Le blanking constitue un bon point de référence pour reconnaître les zones de la vidéo qui ne comportent pas d'informations de couleur.

Si votre vidéo est teintée, les noirs du signal vont se décentrer. Plus vous éloignerez les points du centre, plus la teinte de votre vidéo sera prédominante. C'est pourquoi l'affichage Vectorscope est très efficace pour supprimer une teinte non désirée et rétablir une balance des blancs appropriée.

L'affichage Vectorscope vous permet d'accentuer au maximum les couleurs de votre vidéo tout en évitant d'ajouter accidentellement des teintes non désirées à vos tons foncés et à vos tons clairs. Bien que la balance des couleurs puisse être contrôlée sur les affichages Parade RGB et Vectorscope, les problèmes de balance des couleurs sont souvent plus faciles à repérer sur le vecteurscope.

Lorsque vous faites de la correction colorimétrique sur des séquences comportant de la peau humaine, particulièrement des visages, la balance devrait se situer sur une diagonale à environ 10 heures sur votre vecteurscope. Cette ligne correspond à la teinte de la peau et est basée sur la couleur du sang juste sous la surface de la peau. Elle est donc applicable à toutes les couleurs de peau et permet de donner une allure naturelle à vos personnages.

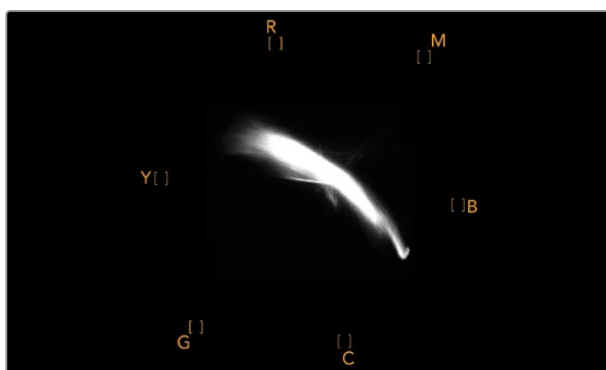

Vecteurscope affichant la ligne correspondant à la teinte de la peau à la position de 10 heures.

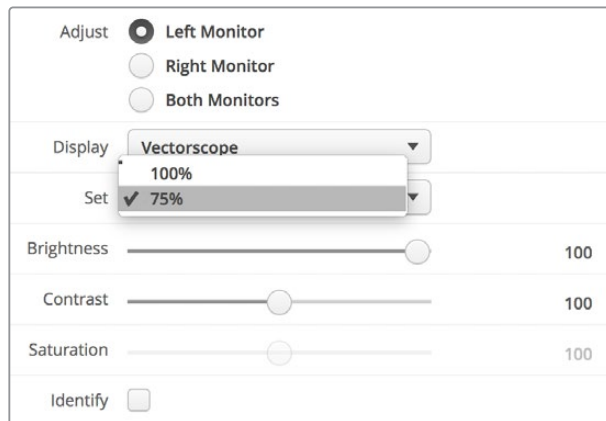

Réglez la mire de barres couleurs sur 100% ou sur 75%.

Affichages Parade

Les affichages RGB et YUV Parade sont parfaits pour la correction colorimétrique, ainsi que pour vérifier les couleurs illégales et les niveaux des couleurs.

Lors de la correction colorimétrique, sélectionnez **RGB Parade** dans le menu déroulant **Display** du Blackmagic SmartView Setup. L'affichage RGB Parade affiche l'intégralité des canaux de couleur rouge, vert et bleu. Le contrôle des niveaux des canaux de couleur facilite la correction colorimétrique et la visualisation de la balance des couleurs dans les tons foncés, moyens et clairs du signal vidéo. L'affichage RGB Parade vous permet d'identifier les détails communs aux canaux rouge, vert et bleu. Vous pouvez ainsi facilement équilibrer les couleurs et supprimer les nuances de couleur indésirables.

Lors de la correction colorimétrique, il est important de veiller à ce que les niveaux vidéo ne soient pas écrêtés. Si vous souhaitez augmenter le niveau vidéo, assurez-vous qu'il ne dépasse pas la limite RGB supérieure, ou vous aurez affaire à des niveaux illégaux. En fonction des appareils que vous utilisez, certains vous permettront ou non de générer des niveaux RGB illégaux à 100%. Grâce au SmartScope Duo 4K, vous pouvez visualiser les niveaux illégaux dès qu'ils se produisent.

La vidéo illégale peut survenir dans les tons foncés ainsi que dans les tons clairs. Dans certains systèmes de correction colorimétrique, les niveaux des tons foncés peuvent être baissés au-dessous de la ligne 0%. Si vous remarquez des niveaux de tons foncés illégaux, ajoutez un peu de lift ou de gain pour les éliminer. Toutefois, il faudra contrôler que le signal vidéo n'est pas monté trop haut et n'a pas généré de couleurs illégales dans les tons clairs.

Pour vérifier les niveaux YUV, sélectionnez **YUV Parade** dans le menu déroulant **Display**. Cet affichage est utile, car il sépare les valeurs de luma (luminance) et de chroma (chrominance). C'est aussi le format utilisé pour la diffusion télévisuelle. La forme d'onde de gauche affiche les informations de luminance tandis que les deux autres formes d'onde affichent les informations de chrominance. L'affichage YUV Parade est utile pour calibrer les valeurs chromatiques du signal vidéo selon une mire de barres couleurs. Ainsi, les couleurs seront fidèlement représentées sur les téléviseurs.

La correction colorimétrique demande un réglage continu afin d'obtenir les meilleures images possibles sans générer de niveaux illégaux.

Terminologie relative à la correction colorimétrique

Noirs – Niveaux des noirs ou des tons foncés du signal vidéo.

Tons moyens – Niveaux des tons moyens du signal vidéo.

Blancs – Niveaux des blancs ou des tons clairs du signal vidéo.

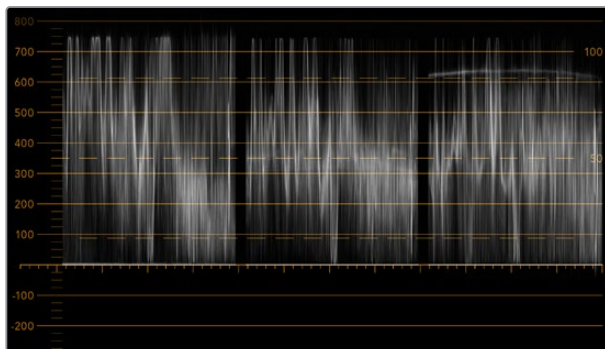

Affichage RGB Parade

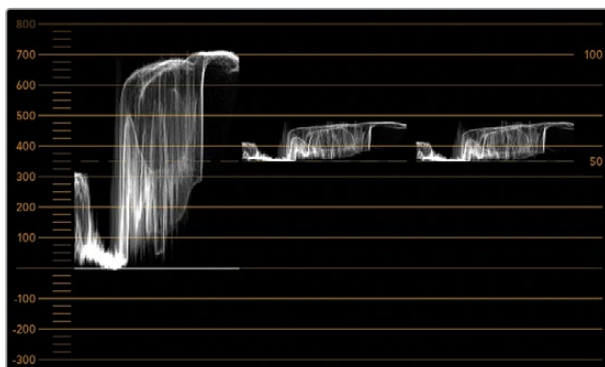

Affichage YUV Parade

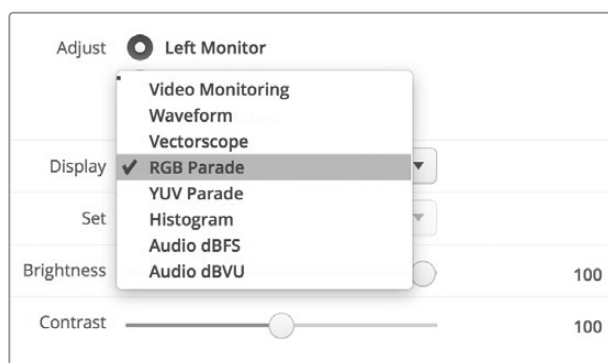

Choisissez entre **RGB Parade** et **YUV Parade** dans le menu déroulant **Display** du Blackmagic SmartView Setup.

Affichage Histogram

L'affichage Histogram est l'affichage le plus couramment utilisé par les graphistes et les cadresurs. Il montre la distribution des tons clairs et foncés et vous permet de vérifier à quelle distance de la ligne d'écrtage ils se trouvent. L'affichage Histogram vous permet également de visualiser les effets causés par les modifications de gamma dans votre vidéo.

Les tons sombres sont situés à gauche de l'affichage et les tons clairs se trouvent à droite. Toute la vidéo devrait normalement se trouver entre les lignes 0% et 100% de l'histogramme. Votre vidéo sera écrêtée si elle se situe en-dessous de 0% ou au-dessus de 100%. L'écrtage vidéo est une chose à éviter à tout prix lors du tournage, car les détails des tons foncés et des tons clairs doivent être préservés si vous désirez par la suite effectuer de la correction colorimétrique en studio. Lors du tournage, gardez la vidéo au-dessus de la ligne d'écrtage des tons foncés et au-dessous de celle des tons clairs. Cela vous donnera plus de liberté ultérieurement pour ajuster les couleurs sans que les tons clairs et foncés aient l'air uniformes et manquent de détails.

Pendant la phase de correction colorimétrique, vous pouvez décider d'écrté la vidéo. Dans ce cas-là, l'affichage Histogram vous permettra de visualiser les effets de l'écrtage sur la vidéo et vous indiquera ce qui a été écrté. Vous pouvez également utiliser le gamma pour créer un rendu similaire, avec moins d'écrtage et en conservant plus de détails.

L'affichage Histogram ne vous permet pas de vérifier s'il y a des niveaux de couleurs illégaux, mais il vous permet de visualiser les valeurs illégales dans les tons clairs et les tons foncés. Cet affichage ne montre pas les couleurs, c'est pourquoi, même s'il n'affiche que des niveaux légaux, votre vidéo peut quand même contenir des couleurs illégaux. Comme mentionné précédemment, l'affichage RGB Parade est le meilleur moyen de vérifier la présence de niveaux illégaux, car il les affiche à la fois dans les éléments en couleurs et dans les éléments de luminance du signal vidéo.

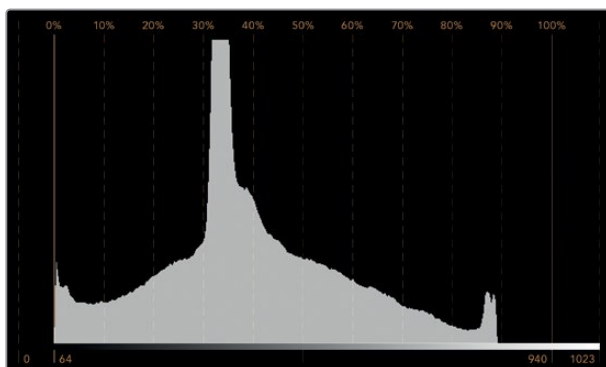

L'affichage Histogram montre la distribution des tons clairs et des tons foncés.

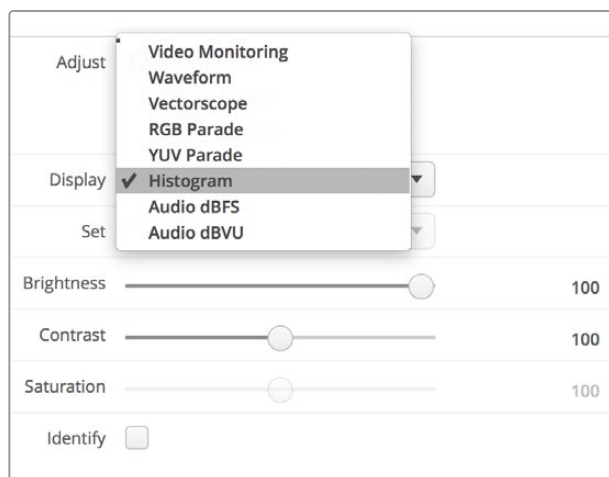

Sélectionnez **Histogram** dans le menu déroulant **Display** du Blackmagic SmartView Setup.

Affichages des niveaux audio

Les affichages des niveaux audio vous indiquent les niveaux de l'audio intégré au signal vidéo SDI. Jusqu'à 16 canaux d'audio intégré sont isolés puis affichés au format dBVU ou dBFS.

Le vumètre indique les niveaux moyens du signal, il est simple d'utilisation et très fréquemment utilisé sur du matériel plus ancien. Le standard VU est calibré à partir de la recommandation de la SMPTE suivante : une tonalité de test de 1 kHz est réglée à -20 dBFS.

Le dBFS est une mesure de l'ensemble du signal audio numérique. On le retrouve fréquemment sur le matériel numérique moderne.

Le scope audio de droite peut afficher deux canaux audio que vous pouvez sélectionner dans le menu déroulant **Set**, par ex. ch 1 & 2, ch 3 & 4 etc. Le scope audio présente l'audio en mode X-Y afin que vous puissiez voir les problèmes de balance audio et de déphasage. Il vous indique également si une piste audio est mono ou stéréo. L'audio mono devrait apparaître en tant que ligne unique, verticale et "en phase". Si la ligne est horizontale, votre audio est déphasé et il se peut qu'il soit annulé (perte d'audio) lorsqu'il est reçu par du matériel en aval. Les erreurs de phase audio sont les erreurs les plus courantes sur les grandes installations où les câbles ne sont pas toujours connectés convenablement.

Lors du monitoring de signaux stéréo, la ligne du scope audio de droite s'étend pour représenter la différence entre les canaux audio gauche et droit. Plus la piste audio contient de son stéréo, plus la ligne prendra une forme circulaire. Lorsque l'audio ne contient qu'un peu de contenu stéréo, l'affichage est concentré autour de l'axe vertical.

L'audio représentant du dialogue apparaît généralement en tant que ligne verticale, tandis que la musique qui contient du son stéréo renfle le scope. En effet, le son mono (L+R) s'affiche sur un axe vertical, alors que le son stéréo (L-R) s'affiche sur un axe horizontal.

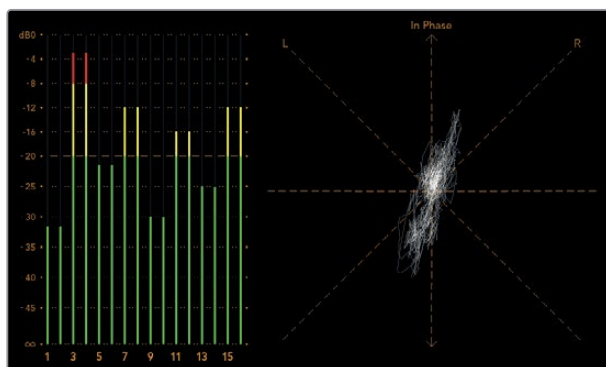

Affichage des niveaux audio indiquant des niveaux de crête ainsi que la balance audio.

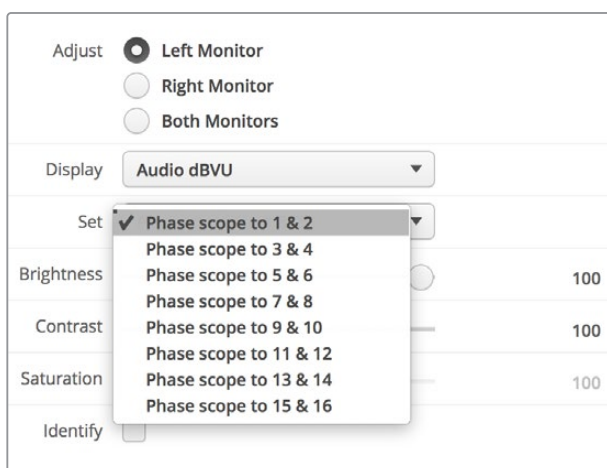

Affichage des niveaux audio indiquant des niveaux de crête ainsi que la balance audio.

Connexion à un réseau

Si vous souhaitez ajuster à distance les paramètres de plusieurs appareils SmartView et SmartScope, vous pouvez les connecter à un réseau.

Bien que les moniteurs SmartView et SmartScope affichent la vidéo sans devoir être configurés, il faudra quand même régler les paramètres réseau. La configuration réseau peut seulement être effectuée à l'aide d'une connexion USB directe à un ordinateur.

Connexion Ethernet directe

La configuration à distance du moniteur peut être effectuée à l'aide d'une connexion Ethernet directe à un ordinateur. Aucun commutateur réseau n'est requis, ce qui est pratique si vous devez installer rapidement votre équipement. Des appareils supplémentaires peuvent être reliés en chaîne à l'aide de la connexion Ethernet en boucle active de chaque appareil. Pour cela, tous les appareils de la chaîne doivent être alimentés.

Si vous souhaitez connecter plusieurs appareils sans utiliser les adresses IP de votre réseau, ou si vous n'avez pas de réseau, il suffit de les connecter directement au port Ethernet de votre ordinateur. C'est une manière rapide de connecter des appareils SmartView et SmartScope via Ethernet, car il n'est pas nécessaire de relier des câbles à un commutateur réseau.

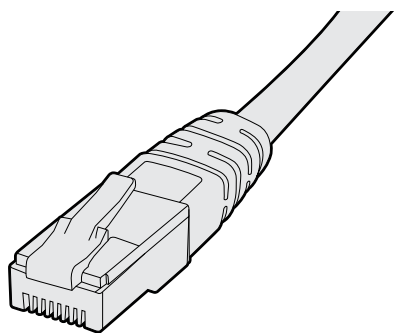

Connexion Ethernet

Commutateur réseau Ethernet

Si vous souhaitez connecter plusieurs appareils au réseau de votre studio, il suffit de brancher un appareil SmartView ou SmartScope au commutateur réseau. Les autres appareils peuvent être reliés en chaîne à l'aide de la connexion en boucle Ethernet active de chaque appareil afin de n'utiliser qu'un seul port de votre commutateur. Ainsi, vous n'aurez pas besoin de relier plusieurs câbles au commutateur réseau. Pour que cela fonctionne, tous les appareils de la chaîne doivent être alimentés.

Lorsque vous connectez des appareils à un commutateur réseau, vous pouvez modifier leurs paramètres à partir de tous les ordinateurs du réseau. Il est également possible de modifier des paramètres à partir d'un ordinateur portable Mac ou Windows via une connexion WiFi si votre réseau comprend un point d'accès wireless.

Suivez ces étapes pour connecter un SmartView ou un SmartScope à un réseau IP local.

- 1 Connectez et alimentez l'appareil.
- 2 Connectez l'appareil à un commutateur réseau, ou directement à un ordinateur à l'aide d'un câble Ethernet RJ45 standard.

Schéma de connexion Ethernet directe

Vous pouvez connecter le port Ethernet d'un ordinateur directement à l'appareil sans commutateur réseau. Les appareils supplémentaires peuvent être reliés en chaîne. Ainsi, vous n'aurez pas besoin de relier plusieurs câbles à un commutateur réseau. Tous les appareils de la chaîne doivent être alimentés.



Schéma de connexion avec un commutateur réseau Ethernet

Si vous souhaitez connecter plusieurs appareils au réseau de votre studio, il suffit de brancher un appareil au commutateur réseau. Les autres appareils peuvent être reliés en chaîne. Ainsi, vous n'aurez pas besoin de relier plusieurs câbles au commutateur réseau. Tous les appareils de la chaîne doivent être alimentés.

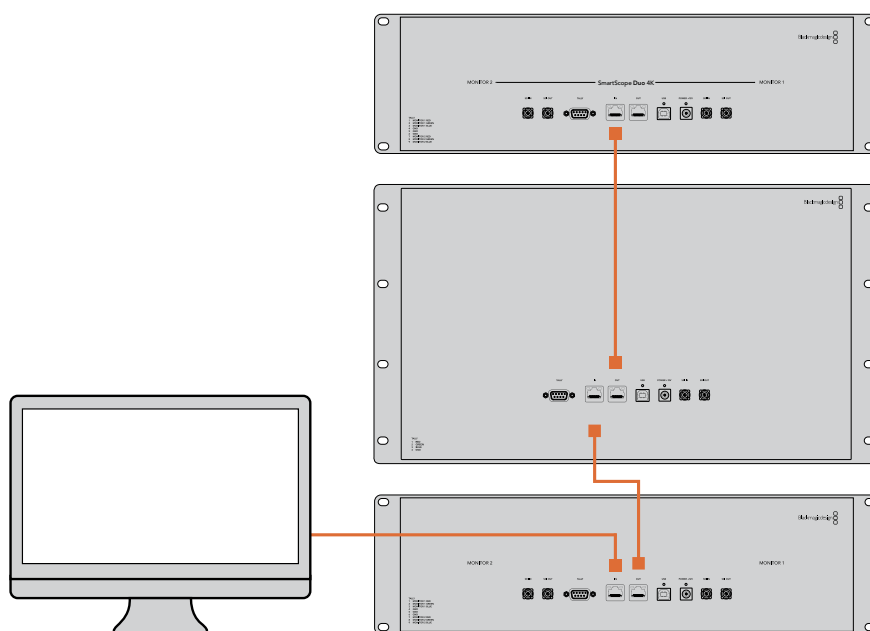
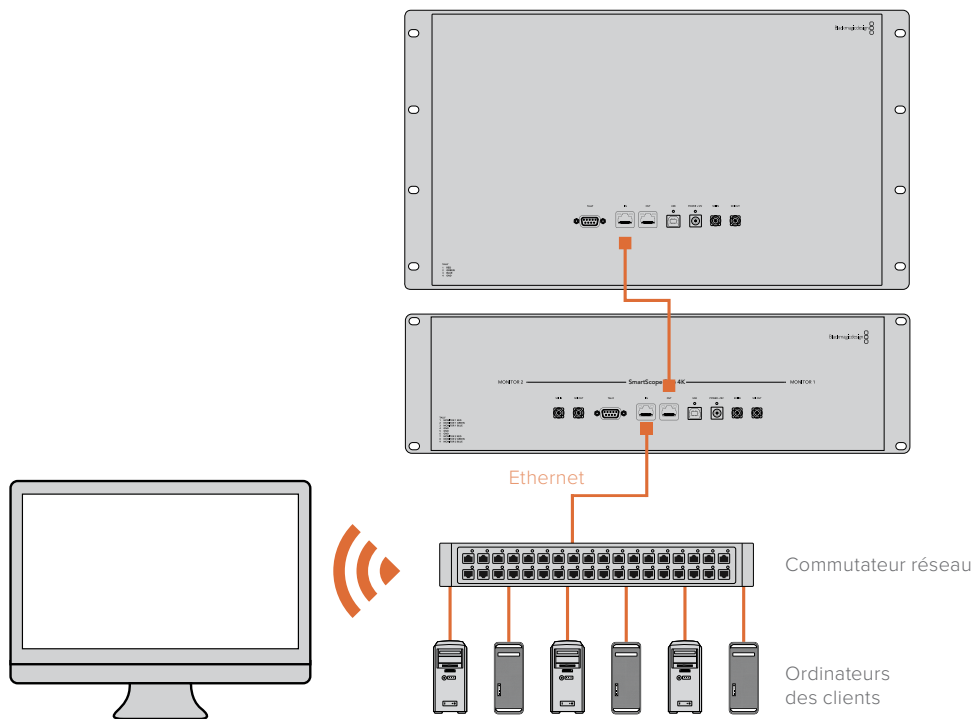

Modifier les paramètres réseau

Paramètres réseau

Nom de l'appareil

Il est judicieux de modifier le nom de votre moniteur afin que chaque appareil SmartView ou SmartScope soit facile à identifier sur le réseau, par ex. « Caméras 1&2 », « Sortie Multi View », « Flux 4K » etc.

Lorsque vous changez le nom du moniteur, veillez à ce que le moniteur soit connecté via USB ou Ethernet. Lancez le Blackmagic SmartView Setup et cliquez sur l'icône de paramétrage situé sous le nom du moniteur. Dans la page de paramétrage, cliquez sur **Network** et modifiez le nom de votre moniteur dans la section **Details**. Si le nom choisi n'est pas valide, une icône d'avertissement apparaîtra à côté du nom. Si le nom est valide, une coche verte s'affichera. Appuyez sur la touche **Retour** de votre clavier pour confirmer le changement de nom.

Paramètres réseau

Pour apporter des changements aux paramètres réseau du Blackmagic SmartView Setup, votre moniteur Blackmagic doit être branché à un ordinateur via USB. Les paramètres réseau ne peuvent pas être modifiés via Ethernet.

Par défaut, le SmartView et le SmartScope utilisent le protocole DHCP pour obtenir automatiquement une adresse IP à partir du réseau.

Si vous ne possédez pas de serveur DHCP, vous pouvez activer la fonctionnalité **Partage Internet** de macOS, ou **Partage de connexion Internet** de Windows 8.1 ou Windows 10, afin de fournir des adresses DHCP aux appareils en liaison directe. Cela vous évitera de devoir attribuer manuellement des adresses IP statiques à chaque appareil. Vous pouvez utiliser cette fonctionnalité pour obtenir des adresses DHCP, même si votre ordinateur ne possède pas de connexion Internet. Le partage Internet est décrit dans les documents d'aide de macOS et de Windows 8.1 et 10.

Si le DHCP ne peut pas être utilisé dans votre configuration, choisissez une adresse IP statique. Veuillez demander une adresse IP disponible à votre administrateur système afin d'éviter de créer un conflit IP sur votre réseau. Vous devrez spécifier une adresse IP unique pour chaque appareil SmartView et SmartScope ainsi qu'un masque de sous-réseau commun. Il n'est pas nécessaire de changer la valeur par défaut du champ **Passerelle** à moins que vous ne souhaitiez connecter vos appareils à une passerelle réseau, telle qu'un routeur.

Si aucun monitor SmartView ou SmartScope n'a été trouvé sur le réseau, il se peut que les appareils n'aient pas reçu d'adresse IP via DHCP. Il faudra donc configurer manuellement chaque appareil avec les paramètres réseau appropriés.

- 1 Connectez un moniteur SmartView ou SmartScope à votre ordinateur via USB et lancez le logiciel Blackmagic SmartView Setup.
- 2 Le moniteur connecté s'affiche automatiquement sur la page d'accueil du SmartView Setup. Une icône USB apparaît à côté de son nom.
- 3 Ajustez les paramètres réseau du moniteur.
- 4 Répétez ces étapes pour tous les appareils qui n'ont pas reçu d'adresse IP via DHCP.

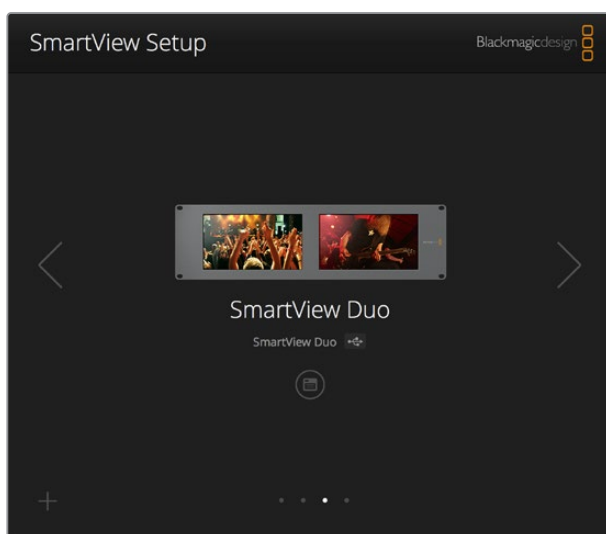

L'icône USB située à côté du nom du moniteur indique que le moniteur est connecté à votre ordinateur via USB. Pour modifier les paramètres réseau, votre moniteur Blackmagic doit être connecté via USB.

Monitor **Configure**

Details

Name: SmartView Duo

Software Version: 4.0.1

Network Settings

IP setting: DHCP Static IP

IP Address: 192.168.10.42 ✓

Subnet Mask: 255.255.255.0

Gateway: 192.168.10.1

Cancel Save

Les paramètres réseau peuvent être réglés afin d'utiliser une adresse IP DHCP ou statique. Ils ne peuvent être modifiés que via USB.

Ajouter un moniteur Blackmagic

Si vous connaissez l'adresse IP d'un SmartView ou d'un SmartScope Duo 4K mais qu'elle n'apparaît pas automatiquement sur la page d'accueil du Blackmagic SmartView Setup, vous pouvez ajouter ce moniteur manuellement. Pour ce faire :

- 1 Veillez à ce que le moniteur soit connecté via Ethernet. Cliquez sur l'icône **+** située au coin gauche de la page d'accueil pour ouvrir la fenêtre permettant d'ajouter un moniteur Blackmagic.
- 2 Saisissez l'adresse IP du moniteur et cliquez sur **Add**.
- 3 Le logiciel vérifie la présence de l'appareil et l'ajoute aux moniteurs Blackmagic affichés sur la page d'accueil du SmartView Setup. Cliquez sur la flèche droite pour voir le moniteur que vous venez d'ajouter.

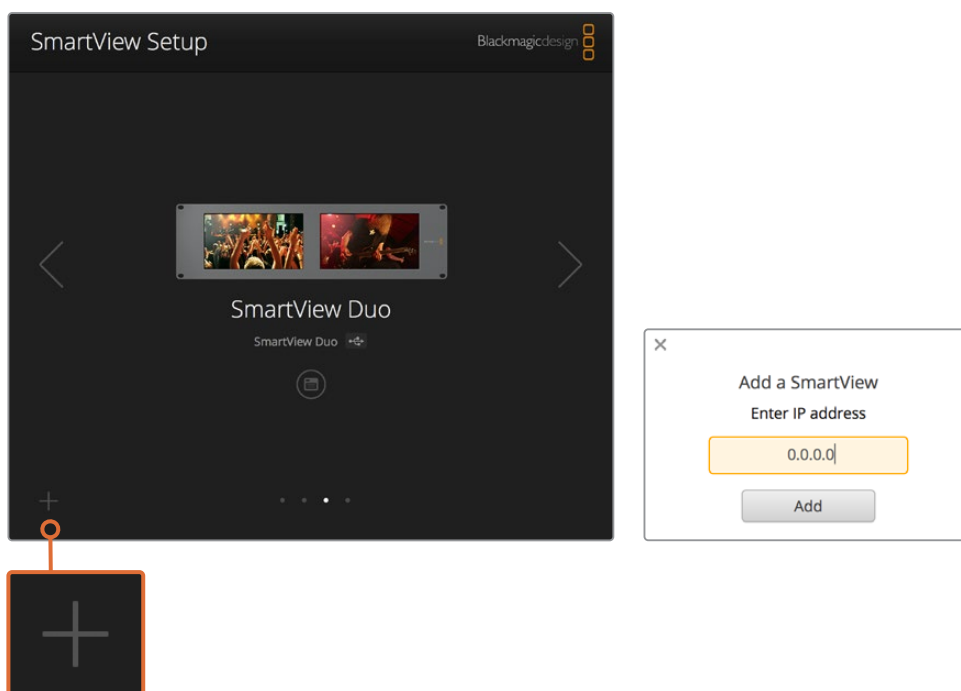

Vous pouvez ajouter manuellement un moniteur SmartView ou SmartScope à la liste des moniteurs connectés en cliquant sur l'icône + et en saisissant l'adresse IP du moniteur.

Utilisation du tally

Broches du port tally

Il n'est pas nécessaire de connecter le port tally du SmartView ou du SmartScope. Vous pouvez donc ignorer cette section si vous ne souhaitez pas utiliser la fonctionnalité tally.

Chaque écran du SmartView ou du SmartScope intègre des bordures tally indépendantes rouges, vertes, ou bleues. Elles peuvent être utilisées pour indiquer l'état d'un signal vidéo, par exemple à l'antenne, en prévisualisation ou en cours d'enregistrement.

Le port tally D-sub à 9 broches accepte les signaux de fermeture de contact provenant de mélangeurs et de systèmes d'automatisation. Veuillez consulter le schéma de brochage tally ci-dessous pour obtenir des informations concernant le câblage du port tally afin de l'utiliser avec un mélangeur ou un système d'automatisation.

La description du câblage du port D à 9 broches est imprimée à l'arrière de l'appareil. Elle indique les fermetures de contact permettant d'afficher les bordures tally rouges, vertes ou bleues sur chaque moniteur.

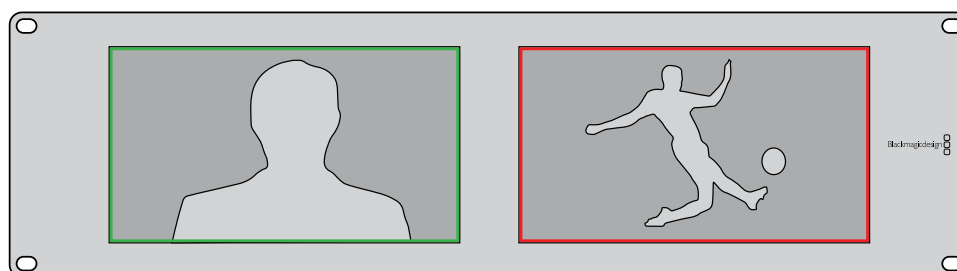

SmartView Duo affichant des bordures tally vertes et rouges.

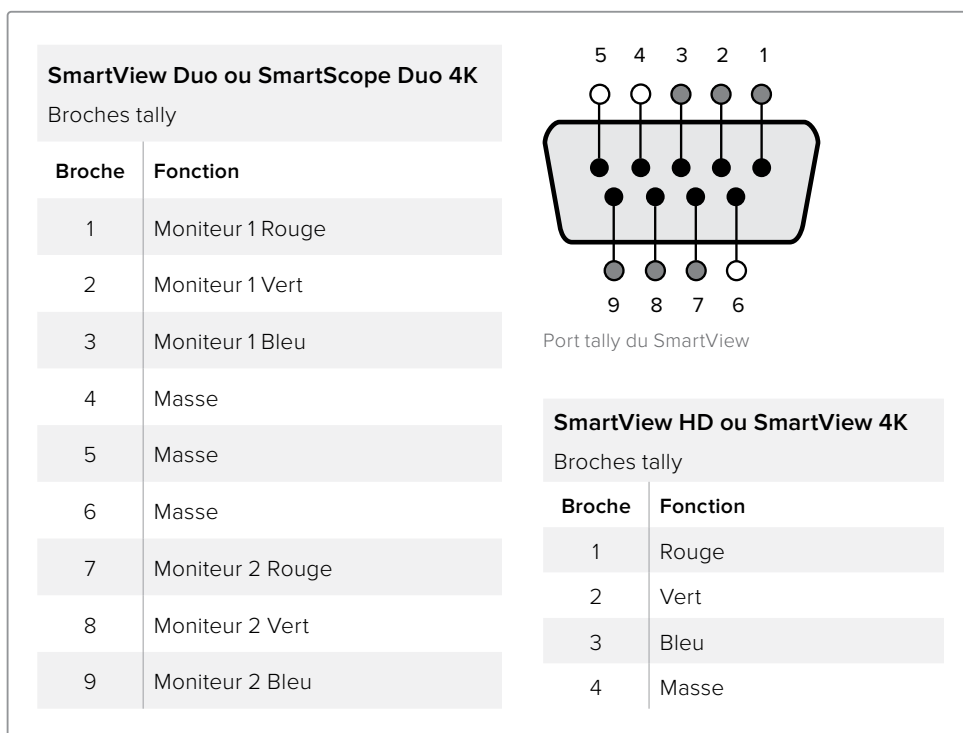

Optimiser l'angle de vision

Si le SmartView Duo, le SmartView HD ou le SmartScope doivent être installés dans la partie supérieure d'un rack d'équipement, il se peut que vous souhaitiez inverser les écrans LCD pour obtenir un angle de vision optimal. En cas d'inversion, les images des écrans LCD prendront automatiquement l'orientation appropriée. Un tournevis Pozidriv 2 est requis pour déconnecter et reconnecter la plaque frontale de l'assemblage arrière. Cette procédure est simple et ne demande pas d'ouvrir l'assemblage arrière.

Les étapes suivantes décrivent comment inverser l'appareil tout en gardant le logo de Blackmagic Design dans le bon sens sur la plaque frontale. Un tournevis Pozidriv 2 est requis.

- 1 Retirez les vis situées sur le haut, le bas, le côté gauche et le côté droit de la plaque frontale. Le SmartView Duo et le SmartScope Duo 4K possèdent 10 vis, tandis que le SmartView HD en possède 18.
- 2 Séparez la plaque frontale de l'assemblage arrière comme illustré ci-dessous.
- 3 Retournez l'assemblage arrière.
- 4 Réintégrez la plaque frontale à l'assemblage arrière.
- 5 Revissez les vis dans le châssis.

Votre SmartView ou SmartScope est maintenant prêt à être installé dans la partie supérieure d'un rack. Une fois installé sur le rack, le SmartView affiche un angle de vision optimal même en cas de secousses, car il ne possède pas de molettes ou de commandes externes qui pourraient se dérégler ou se détacher.



Il est judicieux de tester l'inversion afin de vérifier l'angle de vision optimal avant d'installer l'appareil sur le rack.

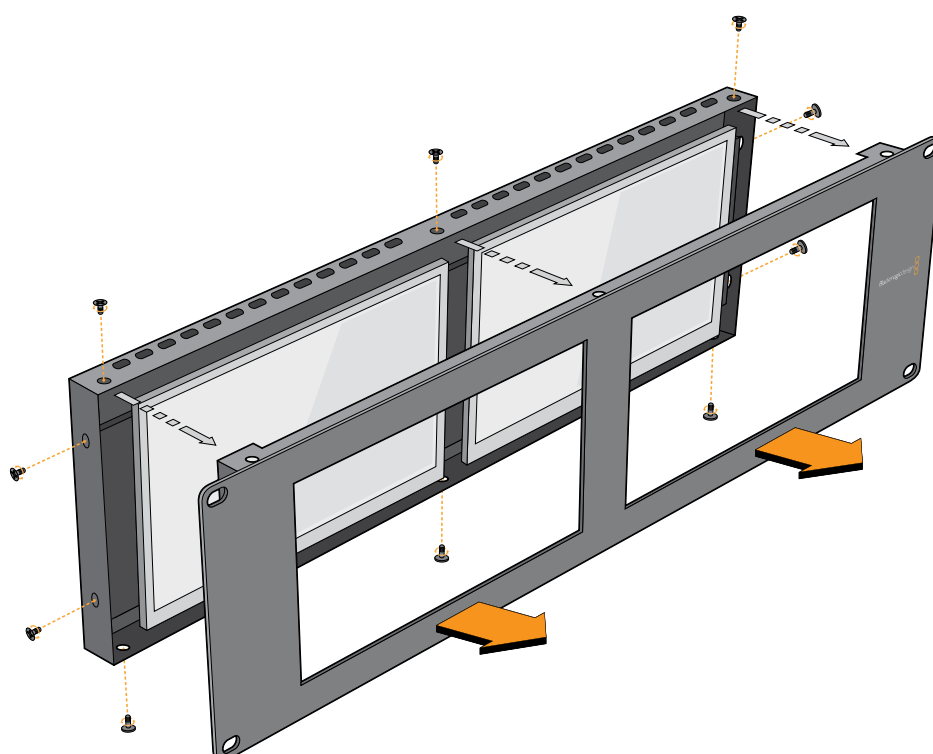

Retirez toutes les vis afin de séparer la plaque frontale de l'assemblage arrière.

Developer Information

Developing Custom Software Using Blackmagic Design Hardware

The Blackmagic SmartView Ethernet Protocol allows developers to remotely control Blackmagic SmartView and SmartScope hardware with their own custom software. The Blackmagic SmartView Ethernet Protocol is a text-based status and control protocol.

Downloading the Free SmartView Ethernet Protocol

The Blackmagic SmartView Ethernet Protocol is free. It is included in this SmartView & SmartScope manual and can be downloaded from <http://www.blackmagicdesign.com/support/>

Joining the Blackmagic Design Developer List

The Blackmagic Developer mailing list is designed for technical questions regarding technologies used by Blackmagic Design, e.g., QuickTime, Core Media, DirectShow, codecs, APIs, SDKs, etc. The free mailing list is a forum where developers can discuss ideas and problems with other developers. Any subscriber may reply and the Blackmagic Design engineers may also respond when appropriate. You can subscribe to the mailing list at: <http://lists.blackmagicdesign.com/mailman/listinfo/bmd-developer>

In some cases, we might request a brief outline of the software you are developing if it is not immediately obvious from your domain name that your organization develops video software. Please don't take offence as we're simply trying to keep the list free of spam and viruses as well as end-user customers asking non-development questions, employment agents or sales people trying to promote products on the list. The list is just for developers.

Contacting Blackmagic Design Developer Assistance

You can also contact us via developer@blackmagicdesign.com if you have any developer related questions or wish to ask questions off the list.



Blackmagic 2K Format – Overview

Blackmagic Design products support 3G-SDI video, which allows twice the data rate of traditional HD-SDI video. We thought it would be a really nice idea to add 2K film support, via 3G-SDI technology, so we could simplify feature film workflows. With the popularity of Blackmagic Design editing systems worldwide, now thousands of people can benefit from a feature film workflow revolution.

This information includes everything product developers need to know for building native 2K SDI equipment. Of course, all Blackmagic products can be updated, so if the television industry adopts an alternative SDI-based film standard, we can add support for that too!

Frame Structure

- Transmitted at 23.98, 24 or 25 frames per second as a Progressive Segmented Frame.
- Active video is 2048 pixels wide by 1556 lines deep.
- Total lines per frame : 1650
- Active words per line are 1535. One word consists of a 10-bit sample for each of the four data streams, i.e., a total of 40 bits. See the diagram named Blackmagic 2K Format - Data Stream Format.
- Total active lines : 1556
- Total words per line : 1875 for 23.98/24Hz and 1800 for 25Hz.
- Fields per frame : 2, 825 lines each
- Active lines located on lines 16-793 (field 1) and 841-1618 (field 2).

Transport Structure

- Based on SMPTE 372M Dual Link mapping and SMPTE 425M-B support for mapping SMPTE 372M into a single 3 Gb/s link.
- Timing reference signals, line number and line CRC insertion is the same as above.
- During active video, 10-bit Red, Green and Blue data is sent in the following sequence:
- Optional ancillary data is inserted into both virtual interfaces.
- At present, only audio data is included: as per standard HD audio insertion (SMPTE S299M) the audio data packets are carried on data stream two and audio control packets are carried on data stream one.
 - Data stream 1: Green_1, Green_2, Green_3, Green_5...Green_2047
 - Data stream 2: Blue_1, Blue_2, Green_4, Blue_5...Green_2048.
 - Data stream 3: Red_1, Blue_3, Blue_4, Red_5...Blue_2048.
 - Data stream 4: Red_2, Red_3, Red_4, Red_6...Red_2048.

Blackmagic 2K Format – Vertical Timing Reference

This diagram shows the vertical timing details with line numbers and Field, Vertical and Horizontal bits for the Timing Reference Signal codes.

		Field 1					Active					
F	1	0	0	0	0	0	0	0	0	0	0	0
V	1	1	1	1	1	1	0	0	0	0	1	1
LINE #	1650	1	2	...	14	15	16	...	792	793	...	825

		Field 2					Active					
F	0	1	1	1	1	1	1	1	1	1	1	1
V	1	1	1	1	1	1	0	0	0	0	1	1
LINE #	825	826	827	...	839	840	841	...	1617	1618	...	1650

Blackmagic 2K Format – Data Stream Format

This diagram shows the data stream formats around the optional ancillary data section of the horizontal line. Note that each active pixel takes up three samples.

Word# 25 PsF	Word# 23.98/24 PsF	Data Stream 4	Data Stream 3	Data Stream 2	Data Stream 1
1795	1870	R2042	R2041	B2041	G2041
1796	1871	R2043	B2043	B2042	G2042
1797	1872	R2044	B2044	G2044	G2043
1798	1873	R2046	R2045	B2045	G2045
1799	1874	R2047	B2047	B2046	G2046
1800	1875	R2048	B2048	G2048	G2047
1	1	EAV(3FFh)	EAV(3FFh)	EAV(3FFh)	EAV(3FFh)
2	2	EAV(000h)	EAV(000h)	EAV(000h)	EAV(000h)
3	3	EAV(000h)	EAV(000h)	EAV(000h)	EAV(000h)
4	4	EAV(XYZh)	EAV(XYZh)	EAV(XYZh)	EAV(XYZh)
5	5	LN0	LN0	LN0	LN0
6	6	LN1	LN1	LN1	LN1
7	7	CRC0	CRC0	CRC0	CRC0
8	8	CRC1	CRC1	CRC1	CRC1
9	9	200	040	ANC/Audio Data	ANC/Audio Data
...		
260	335	200	040		
261	336	SAV(3FFh)	SAV(3FFh)	SAV(3FFh)	SAV(3FFh)
262	337	SAV(000h)	SAV(000h)	SAV(000h)	SAV(000h)
263	338	SAV(000h)	SAV(000h)	SAV(000h)	SAV(000h)
264	339	SAV(XYZh)	SAV(XYZh)	SAV(XYZh)	SAV(XYZh)
265	340	R2	R1	B1	G1
266	341	R3	B3	B2	G2
267	342	R4	B4	G4	G3
268	343	R6	R5	B5	G5

Blackmagic SmartView Ethernet Protocol v1.3

Summary

The Blackmagic SmartView Ethernet Protocol is a text-based status and control protocol, very similar in structure to the Videohub protocol, that is accessed by connecting to TCP port 9992 on a SmartView or SmartScope device.

Upon connection, the SmartView or SmartScope device sends a complete dump of the state of the device. After the initial dump, state changes are sent asynchronously.

The device sends information in blocks which have an identifying header, followed by a colon. A block can span multiple lines and is terminated by a blank line.

To be resilient to future protocol changes, clients should ignore blocks they do not recognize, up to the trailing blank line. Within recognized blocks, clients should ignore lines they do not recognize.

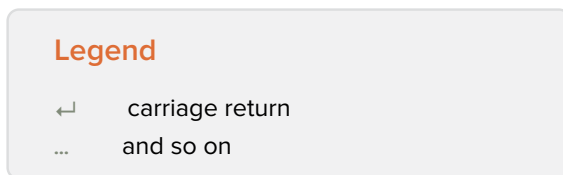

Version 1.3 of the Blackmagic SmartView Ethernet Protocol was released with SmartView 1.3 software.

Protocol Preamble

The first block sent by the SmartView Server is always the protocol preamble:

```
PROTOCOL PREAMBLE:↵
Version: 1.3 ↵
↵
```

The version field indicates the protocol version. When the protocol is changed in a compatible way, the minor version number will be updated. If incompatible changes are made, the major version number will be updated.

Device Information

The next block contains general information about the connected SmartView or SmartScope device.

```
SMARTVIEW DEVICE:↵
Model: SmartView Duo↵
Hostname: stagefront.studio.example.com↵
Name: StageFront↵
Monitors: 2↵
Inverted: false↵
↵
```

This example shows the output for a SmartView Duo device, which has two LCDs. The INVERTED flag indicates whether the device has detected that it has been mounted in an inverted configuration to optimize LCD viewing angle.

Network Configuration

The next block shows the TCP/IP networking configuration:

```
NETWORK:↵  
Dynamic IP: true↵  
Static address: 192.168.2.2↵  
Static netmask: 255.255.255.0↵  
Static gateway: 192.168.2.1↵  
Current address: 192.168.1.101↵  
Current netmask: 255.255.255.0↵  
Current gateway: 192.168.1.1↵  
↵
```

The network settings prefixed with CURRENT show the active TCP/IP settings, and are read-only. The CURRENT settings reflect either the DHCP or Static configuration, depending on the DYNAMIC IP flag.

Changing Networking Settings

The network can be configured to use either DHCP or a static configuration. To enable DHCP:

```
NETWORK:↵  
Dynamic IP: true↵  
↵
```

To set a fixed IP address, supply all static parameters, thus:

```
NETWORK:↵  
Dynamic IP: false↵  
Static address: 192.168.2.2↵  
Static netmask: 255.255.255.0↵  
Static gateway: 192.168.2.1↵  
↵
```

The parameters with the CURRENT prefix are read-only, and show the active configuration, regardless of the static or dynamic setting.

Changing the device name, or any network settings, will cause the IP connection to be dropped. The device will restart its networking and advertise its new name on the network.

Changing Monitor Settings

The display settings for each monitor are specified individually. One or more parameters can be modified at the same time and multiple settings can be supplied in one block.

The valid range for numeric values is 0-255. The CONTRAST and SATURATION properties are zero-centered, so the normal value is 127, such that the displayed picture is the same as the original. A value greater than 127 in either channel will cause the contrast or saturation to be increased, and similarly a value less than 127 will cause a decrease.

For example, to set the brightness to 50% and desaturate the image to Black & White:

```
MONITOR A:↵  
Brightness: 127↵  
Saturation: 0↵  
↵
```

Displaying SD in 16:9

The following command sets standard definition video to display in 16:9:

```
MONITOR A:↵  
WidescreenSD: ON↵
```

Displaying SD in 4:3

The following command sets standard definition video to display in 4:3:

```
MONITOR A:↵  
WidescreenSD: OFF↵
```

Identification and Tally Settings

The Identify flag is transient, and will cause a white border to be displayed around the entire picture for a duration of 15 seconds, after which it will be reset. This feature is primarily aimed at identifying which monitor is currently being configured when it is mounted in a rack comprising multiple units. To turn on:

```
MONITOR A:↵  
Identify: true↵  
↵
```

The IDENTIFY border will temporarily override any other border setting in effect.

The BORDER property can be used to programmatically set the soft Tally colored borders to one of the primary colors: RED, GREEN, BLUE, WHITE or NONE. This setting can be overridden by the electrical Tally signals at the DB-9 input on the device itself. For example, to set the soft Tally to green:

```
MONITOR B:↵  
Border: green↵  
↵
```

The hard wired tally will always override the soft tally. The full state report will always show the current valid border.

SmartScope Settings

On SmartScope Duo 4K, each monitor can be set to display a different scope. The values for activating specific scopes are mapped as follows:

- AudioDbfs
- AudioDbvu
- Histogram
- ParadeRGB
- ParadeYUV
- Picture (This is the same as Video Monitor)
- Vector100
- Vector75
- WaveformLuma

```
MONITOR A:↵  
ScopeMode: Picture↵  
↵
```

In the example above, Monitor A has been set as a video monitor.

Displaying SD in 16:9

The set Video Monitor mode to display standard definition video in 16:9:

```
MONITOR A:↵  
ScopeMode: Picture↵  
WidescreenSD: ON↵
```

Displaying SD in 4:3

To set Video Monitor mode to display standard definition video in 4:3:

```
MONITOR A:↵  
ScopeMode: Picture↵  
WidescreenSD: OFF↵
```

When setting one of SmartScope Duo 4K's monitors to audio metering, you can also select which channels to show. The values for selecting which audio channels are mapped in the following way:

- 0: Channels 1 and 2
- 1: Channels 3 and 4
- 2: Channels 5 and 6
- 3: Channels 7 and 8
- 4: Channels 9 and 10
- 5: Channels 11 and 12
- 6: Channels 13 and 14
- 7: Channels 15 and 16

```
MONITOR B:↵  
ScopeMode: AudioDbvu↵  
AudioChannel: 0↵
```

```
↵
```

In the example above, Monitor B has been selected to display Audio Metering in Dbvu with audio channels 1 and 2 selected for the phase meter.

Selecting LUTs for SmartView 4K

To select 3D LUTs using SmartView 4K:

```
MONITOR A:↵  
LUT: 0          LUT 1  
      1          LUT 2  
      NONE      DISABLE
```

```
↵
```

```
↵
```

Assistance

Obtenir de l'assistance

Il y a quatre façons d'obtenir de l'assistance :

- 1** Consulter le centre d'assistance technique de Blackmagic Design à l'adresse www.blackmagicdesign.com/fr/support pour obtenir les dernières informations de support technique.
- 2** Contacter votre revendeur Blackmagic Design.
- 3** Votre revendeur possède les dernières mises à jour techniques de Blackmagic Design et devrait pouvoir vous aider immédiatement. Nous vous recommandons également de considérer les options de support offertes par votre revendeur, car il peut proposer une solution adaptée aux exigences de votre workflow.
- 4** Vous pouvez aussi nous envoyer un email à l'aide du bouton « Envoyer un email » de la page d'assistance : www.blackmagicdesign.com/fr/support
- 5** Contacter le service d'assistance de Blackmagic Design par téléphone. Vous pouvez trouver le centre d'assistance le plus proche de chez vous en cliquant sur le bouton « Trouver un support technique » sur la page d'assistance de Blackmagic Design.

Donnez-nous autant d'informations que possible concernant votre problème technique et les spécifications du système afin que nous puissions y répondre le plus rapidement possible.

Avertissements

Élimination des déchets d'équipements électriques et électroniques au sein de l'Union européenne.



Le symbole imprimé sur ce produit indique qu'il ne doit pas être jeté avec les autres déchets. Cet appareil doit être déposé dans un point de collecte agréé pour être recyclé. La collecte individuelle et le recyclage de votre équipement permettra de préserver les ressources naturelles et garantit un recyclage approprié afin d'éviter la contamination de l'environnement par des substances dangereuses pour la santé. Pour obtenir plus d'informations sur les points de collecte pour recycler votre appareil, veuillez contacter l'organisme responsable du recyclage dans votre région ou le revendeur du produit.



Cet équipement a été testé et déclaré conforme aux limites imposées aux appareils numériques de classe A, en vertu du chapitre 15 des règles de la FCC. Ces limites ont pour objectif d'assurer une protection suffisante contre les interférences nuisibles lorsque l'équipement est utilisé dans un environnement commercial. Cet équipement génère, utilise et peut dégager de l'énergie de radiofréquence et, s'il n'est pas installé et utilisé conformément au manuel d'utilisation, peut provoquer un brouillage préjudiciable aux communications radio. L'utilisation de cet équipement en zone résidentielle est susceptible de provoquer des interférences nuisibles, auquel cas il sera demandé à l'utilisateur de corriger ces interférences à ses frais.

L'utilisation de cet appareil est soumise aux deux conditions suivantes :

- 1 Cet appareil ne doit pas causer d'interférences nuisibles.
- 2 Cet appareil doit accepter toute interférence reçue, y compris les interférences qui peuvent provoquer des opérations non désirées.



MSIP-REM-BMD-201410001
MSIP-REM-BMD-20150327
MSIP-REM-BMD-201702004
MSIP-REM-BMD-201702005

Déclaration de ISDE Canada

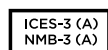

Cet appareil est conforme aux normes canadiennes relatives aux appareils numériques de Classe A.

Toute modification ou utilisation de ce produit en dehors de son utilisation prévue peut annuler la conformité avec ces normes.

Les connexions aux interfaces HDMI doivent être effectuées avec des câbles HDMI blindés d'excellente qualité.

Cet équipement a été testé pour être en conformité avec une utilisation prévue dans un environnement commercial. Si cet équipement est utilisé dans un environnement domestique, il peut provoquer des interférences radio.

Informations de sécurité

Pour une protection contre les décharges électriques, cet appareil doit être connecté à une prise secteur équipée d'un conducteur de protection. En cas de doute, veuillez contacter un électricien qualifié.

Afin de réduire le risque de décharge électrique, ne pas éclabousser ou renverser de liquide sur cet appareil.

Ce produit peut être utilisé dans un climat tropical lorsque la température ambiante n'excède pas 40°C.

Veillez à ce que l'espace autour du produit soit suffisant afin de ne pas compromettre la ventilation.

Lorsque vous installez l'appareil sur rack, veillez à ce que la ventilation ne soit pas compromise par les autres équipements.

Les pièces de cet appareil ne sont pas réparables par l'opérateur. Toute opération d'entretien doit être effectuée par un centre de service Blackmagic Design.

Vous pouvez connecter des modules SFP fibre optique à certains produits. Utilisez seulement des modules SFP équipés de lasers de classe 1.

Modules SFP Blackmagic Design recommandés:

- **3G-SDI**: PL-4F20-311C
- **6G-SDI**: PL-8F10-311C
- **12G-SDI**: PL-TG10-311C



Cet appareil ne peut être utilisé qu'à une altitude inférieure à 2000 mètres.

Déclaration de l'État de Californie

Ce produit est susceptible de vous exposer à des produits chimiques, dont des traces de polybromobiphényle dans les parties en plastique, reconnu par l'État de Californie comme étant responsable de cancers, d'anomalies congénitales ou d'autres effets nocifs sur la reproduction.

Pour de plus amples informations, veuillez vous rendre sur www.P65Warnings.ca.gov.

Garantie

Garantie limitée à 12 mois

Par la présente, Blackmagic Design garantit que ce produit sera exempt de défauts matériels et de fabrication pendant une durée de un an à compter de la date d'achat. Si un produit s'avère défectueux pendant la période de garantie, Blackmagic Design peut, à sa seule discrétion, réparer le produit défectueux sans frais pour les pièces et la main d'œuvre, ou le remplacer.

Pour se prévaloir du service offert en vertu de la présente garantie, il vous incombe d'informer Blackmagic Design de l'existence du défaut avant expiration de la période de garantie, et de prendre les mesures nécessaires pour l'exécution des dispositions de ce service. Le consommateur a la responsabilité de s'occuper de l'emballage et de l'expédition du produit défectueux au centre de service nommément désigné par Blackmagic Design, en frais de port prépayé. Il incombe au Consommateur de payer tous les frais de transport, d'assurance, droits de douane et taxes et toutes autres charges relatives aux produits qui nous auront été retournés et ce quelle que soit la raison.

La présente garantie ne saurait en aucun cas s'appliquer à des défauts, pannes ou dommages causés par une utilisation inappropriée ou un entretien inadéquat ou incorrect. Blackmagic Design n'a en aucun cas l'obligation de fournir un service en vertu de la présente garantie : a) pour réparer les dommages résultant de tentatives de réparations, d'installations ou tous services effectués par du personnel non qualifié par Blackmagic Design, b) pour réparer tout dommage résultant d'une utilisation inadéquate ou d'une connexion à du matériel incompatible, c) pour réparer tout dommage ou dysfonctionnement causé par l'utilisation de pièces ou de fournitures n'appartenant pas à la marque de Blackmagic Design, d) pour examiner un produit qui a été modifié ou intégré à d'autres produits quand l'impact d'une telle modification ou intégration augmente les délais ou la difficulté d'examiner ce produit. CETTE GARANTIE REMPLACE TOUTE GARANTIE EXPLICITE OU IMPLICITE. BLACKMAGIC DESIGN ET SES REVENDEURS DÉCLINENT EXPRESSÉMENT TOUTE GARANTIE IMPLICITE DE COMMERCIALISATION OU D'ADAPTATION DANS QUELQUE BUT QUE CE SOIT. LA RESPONSABILITÉ DE BLACKMAGIC DESIGN POUR RÉPARER OU REMPLACER UN PRODUIT S'AVÉRANT DÉFECTUEUX CONSTITUE LA TOTALITÉ ET LE SEUL RECOURS EXCLUSIF PRÉVU ET FOURNI AU CONSOMMATEUR POUR TOUT DOMMAGE INDIRECT, SPÉCIFIQUE, ACCIDENTEL OU CONSÉCUTIF, PEU IMPORTE QUE BLACKMAGIC DESIGN OU SES REVENDEURS AIENT ÉTÉ INFORMÉS OU SE SOIENT RENDUS COMPTE AU PRÉALABLE DE L'ÉVENTUALITÉ DE CES DOMMAGES. BLACKMAGIC DESIGN NE PEUT ÊTRE TENU POUR RESPONSABLE DE TOUTE UTILISATION ILLICITE OU ABUSIVE DU MATÉRIEL PAR LE CONSOMMATEUR. BLACKMAGIC DESIGN N'EST PAS RESPONSABLE DES DOMMAGES RÉSULTANT DE L'UTILISATION DE CE PRODUIT. LE CONSOMMATEUR MANIPULE CE PRODUIT À SES SEULS RISQUES.

© Copyright 2020 Blackmagic Design. Tous droits réservés. 'Blackmagic Design', 'DeckLink', 'HDLink', 'Workgroup Videohub', 'Multibridge Pro', 'Multibridge Extreme', 'Intensity' et 'Leading the creative video revolution' sont des marques déposées aux USA et dans d'autres pays. Tous les autres noms de société et de produits peuvent être des marques déposées de leurs sociétés respectives auxquelles ils sont associés.



Installations- und Bedienungsanleitung

SmartView & SmartScope

September 2020

Deutsch



Willkommen!

Wir träumen von einer Entwicklung der Fernsehbranche zu einer echten Kreativbranche, die jedermann Zugriff auf Video in höchster Qualität gewährt. Wir hoffen, Sie teilen diesen Traum mit uns und wünschen Ihnen in diesem Sinne kreatives Schaffen.

Videomonitoring ist ein Muss in jeder Einrichtung. Da kommt der SmartView 4K mit seinem integrierten LCD in 4K-Auflösung genau richtig. Denn mit ihm können Sie Ultra-HD-Video in Vollauflösung überprüfen. Und dank seines eleganten Rack-Gehäuses mit 6 HE lassen sich Einstellungen in Windeseile ändern. Der SmartView HD wartet mit einem unglaublichen 17 Zoll großen LCD in einem ebenfalls 6 HE hohen Gehäuse auf und ist weniger als einen Zoll tief. Der SmartView Duo hingegen kommt mit zwei komplett voneinander unabhängigen 8-Zoll-LCDs in einem drei Rackeinheiten hohen Gehäuse und ist ebenfalls weniger als einen Zoll tief. Das Modell SmartScope Duo 4K bietet neben zwei unabhängigen 8-Zoll-LCDs eine Waveform-Funktionalität. Damit haben Sie Ihre Videopegel immer im Auge. Alle SmartView Monitore unterstützen Video in SD, HD und 2K über 3G-SDI. Der SmartScope Duo 4K und der SmartView 4K unterstützen darüber hinaus Ultra HD 4K über 6G-SDI bzw. 12G-SDI.

Das Videomonitoring mit Produkten dieser Familie ist auf der Stelle einsatzbereit: auspacken, anschließen, fertig! Mit der Blackmagic SmartView Setup Software bekommen Nutzer außerdem ein leicht verständliches und intuitives Konfigurations-Tool in die Hand.

Diese Bedienungsanleitung enthält alle nötigen Informationen zur Installation Ihres Blackmagic SmartView und SmartScope. Wenn Sie jedoch Fragen zu IP-Adressen oder Computer-Netzwerken haben, wenden Sie sich bitte an einen technischen Berater. SmartViews und SmartScopes sind einfach zu installieren, allerdings sind anschließend einige Voreinstellungen vorzunehmen, die technisch etwas anspruchsvoller sind.

Unserer Einschätzung nach sollte die komplette Installation nicht mehr als rund 5 Minuten dauern. Besuchen Sie die Support-Seiten auf unserer Website unter www.blackmagicdesign.com/de/support und laden Sie dort die neueste Version dieses Handbuchs und der Software herunter. Bitte registrieren Sie beim Herunterladen der Software Ihr Gerät, damit wir Sie über Software-Aktualisierungen informieren können. Wir arbeiten ständig an neuen Features und Verbesserungen und würden uns über Ihr Feedback freuen!

A handwritten signature in black ink that reads "Grant Petty". The signature is written in a cursive, flowing style.

Grant Petty

CEO, Blackmagic Design

Inhaltsverzeichnis

SmartView & SmartScope

Erste Schritte	125
SmartView und SmartScope	125
Anschließen von Videoquellen	126
Anschließen Ihres Computers	126
Blackmagic SmartView Setup installieren	127
Blackmagic SmartView Setup im Einsatz	128
Aktualisieren der Software	128
Anpassen der Monitoreinstellungen	128
Enable Tally Override	131
Der SmartView 4K im Einsatz	131
Der Blackmagic SmartView 4K	131
Bedientasten	132
3D-LUTs mit Blackmagic SmartView Setup laden	134
Der SmartScope Duo 4K im Einsatz	135
Was ist der Blackmagic SmartScope?	135
Die Video-Monitoring-Anzeige	136
Waveform-Anzeige	137
Vektorskop-Anzeige	138
Parade-Anzeige	139
Histogramm-Anzeige	140
Audiopegelmeter-Anzeige	142
Anschließen an ein Netzwerk	143
Direkte Ethernet-Verbindung	143
Ethernet-Netzwerk-Switch	144
Anpassen von Netzwerkeinstellungen	145
Netzwerkeinstellungen	145
Hinzufügen eines Blackmagic Monitors	147
Arbeiten mit Tally	148
Pinbelegung des Tally-Ports	148
Optimieren des Betrachtungswinkels	149
Informationen für Entwickler (Englisch)	151
Blackmagic 2K Format – Overview	151
Blackmagic 2K Format – Vertical Timing Reference	152
Blackmagic 2K Format – Data Stream Format	153
Blackmagic SmartView Ethernet Protocol v1.3	154
Hilfe	158
Gesetzliche Vorschriften	159
Sicherheitshinweise	160
Garantie	161

Erste Schritte

SmartView und SmartScope

SmartView Monitore eignen sich perfekt für alle Einrichtungen mit rackbasierter Bildkontrolle. Versorgen Sie Ihren SmartView zum Einstieg lediglich mit Strom und schließen Sie eine SDI-Quelle an.

Das Modell SmartView 4K hat ein 15,6 Zoll großes LCD, auf dem Sie SD-, HD- und Ultra-HD-Video in seiner nativen Pixelauflösung von 3840 x 2160 kontrollieren können. Über die Tasten auf dem Frontbedienfeld können Sie spielend leicht Eingänge auswählen, die Helligkeit des Bildschirms anpassen, den blauen Kanal auf Rauschen überprüfen, Informationen zu Austastlücken sichten, 3D-LUTs anwenden u. v. m.

Das 17 Zoll große LCD des SmartView HD Modells eignet sich perfekt für zuverlässiges Monitoring in vollaufgelöstem HD.

Der SmartView Duo verfügt über zwei Monitore für die gleichzeitige Ansicht zweier unterschiedlicher Videosignale. Lassen Sie sich so bspw. auf dem einen Bildschirm ein YUV-4:2:2-Signal und auf dem anderen ein RGB-4:4:4-Signal anzeigen. Alternativ könnte ein Monitor NTSC-Video und der andere PAL-Video wiedergeben. Hierbei sind viele verschiedene Kombinationen möglich. Welche Quelle Sie sich auch anzeigen lassen möchten, schließen Sie sie einfach per SDI an.

Der SmartScope Duo 4K hat dieselben Funktionen wie der SmartView Duo, kann aber zusätzlich Waveform-, Vektorskop- und andere gebräuchliche Messanzeigen für echtzeitbasiertes Video- und Audio-Monitoring anzeigen. Darüber hinaus profitieren Sie von einer kompletten Ultra-HD-4K-Unterstützung.

Die SDI-Eingänge aller SmartView und SmartScope Modelle erkennen SD-, HD- oder 3G-SDI- und 2K-Video automatisch. Der SmartView 4K erkennt außerdem Ultra HD, darunter Formate wie 2160p/60 via 12G-SDI. Der SmartScope Duo 4K hingegen erkennt Ultra-HD-4K-Video via 6G-SDI von selbst.

Wenn Sie die Einstellungen mehrerer SmartView und SmartScope Einheiten von einem Computer aus ändern möchten, haben Sie die Möglichkeit, diese per Ethernet miteinander zu verbinden. So brauchen Sie nicht jede Einheit einzeln per USB-Kabel mit Ihrem Computer zu verbinden, um Einstellungen vorzunehmen.

Für den Anfang war das schon alles. Näheres zum Anschließen Ihres SmartView und SmartScope, zum Konfigurieren der Monitoreinstellungen über Blackmagic SmartView Setup und zum Einbinden in ein Netzwerk erfahren Sie im weiteren Verlauf dieses Handbuchs.



SmartView 4K



SmartView HD



SmartView Duo



SmartScope Duo 4K

Anschließen von Videoquellen

SmartView und SmartScope Monitore verfügen über reguläre BNC-Anschlüsse, über die SDI-Geräte wie Mischer, Kameras, Aufzeichnungskarten, MAZen und Diskrekorder angeschlossen werden können.

Bildmaterial auf dem Monitor sichten

Videobilder auf Ihrem SmartView oder SmartScope zu sichten ist kinderleicht. Versorgen Sie das Gerät lediglich mit Strom und schließen Sie Ihre Videoquelle an einen SDI-Eingang an. Wurden diese beiden Schritte ausgeführt, sollte Ihr Video sofort sichtbar sein. SD-, HD- und 2K-Signale werden vom SDI-Eingang sowie vom Durchschleifausgang automatisch erkannt. SmartView 4K und SmartScope Duo 4K Modelle erkennen außerdem Ultra HD 4K.

Wird vom Gerät kein Video empfangen, erlischt die Hintergrundbeleuchtung. Dadurch wird bis zur erneuten Erkennung eines gültigen Videosignals Strom gespart.

Reihenschaltung von Monitoren

Jeder SmartView und SmartScope Monitor verfügt über einen unabhängigen SDI-Eingang sowie über einen Durchschleifausgang, damit Sie mehrere Monitore in Reihe schalten und dasselbe Signal anzeigen können:

- 1 Schalten Sie Einheit 1 ein. Schließen Sie eine Videoquelle an den SDI-Eingang an. Ihr Video sollte sofort sichtbar sein.
- 2 Schalten Sie Einheit 2 ein. Verbinden Sie nun per SDI-Kabel den Durchschleifausgang von Einheit 1 mit dem SDI-Eingang von Einheit 2.

Sie können beliebig viele Einheiten aneinanderreihen.

Wenn Sie auf einem SmartScope Duo 4K vom Waveform-Monitoring Gebrauch machen, möchten Sie wahrscheinlich die Ausgabe von Monitor 1 zu Monitor 2 durchschleifen, damit beide Monitore dasselbe Eingangssignal verwenden.

Für das jetzt dargestellte Videobild können Sie nun entweder Monitoreinstellungen anpassen oder Scopes für den SmartScope Duo 4K auswählen. Dies geschieht über die Blackmagic SmartView Setup Software. Darüber lassen sich außerdem 3D-LUTs auf Ihren Blackmagic SmartView 4K laden.



SmartView 4K



SmartView HD



SmartView Duo



SmartScope Duo 4K

Anschließen Ihres Computers

Konfigurieren Sie die Monitoreinstellungen Ihres SmartView oder SmartScope, indem Sie Ihren Computer per USB an das jeweilige Gerät anschließen und Blackmagic SmartView Setup installieren.

Über die USB-Verbindung lässt sich zudem die Produktsoftware aktualisieren. Laden Sie Software-Aktualisierungen zunächst von der Blackmagic Design Website herunter. Software-Aktualisierungen können Ihr Gerät um neue Funktionen, Kompatibilität mit neuer Hardware oder Unterstützung neuer Formate erweitern. Blackmagic SmartView Setup läuft sowohl auf macOS als auch auf Windows.

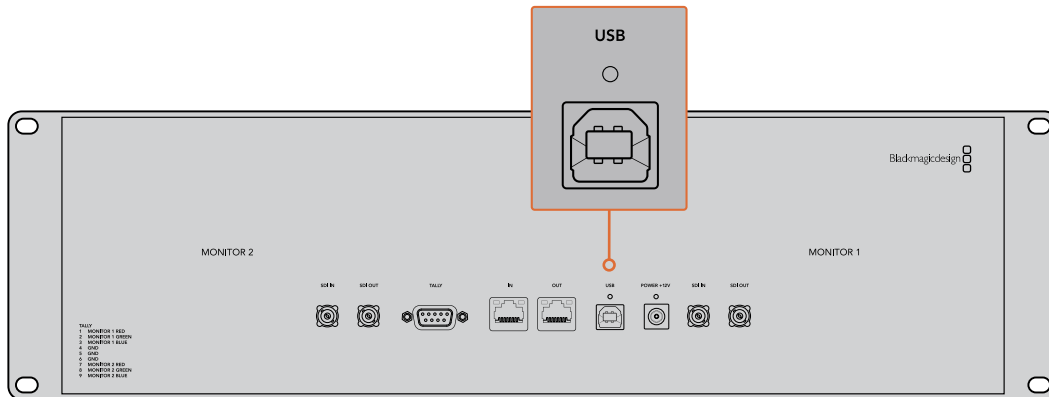

Blackmagic SmartView Setup installieren

Blackmagic SmartView Setup läuft auf den aktuellsten Softwareversionen von Sierra und High Sierra von macOS sowie auf allen 64-Bit-Versionen von Windows 8.1 und 10, bei denen die aktuellsten Service Packs installiert wurden. Blackmagic SmartView Setup lässt sich bei Bedarf auf mehreren Computern im Netzwerk installieren.

Die mit dem SmartView mitgelieferte SD-Karte enthält das Installationsprogramm. Dennoch empfehlen wir Ihnen einen Besuch auf unsere Website unter www.blackmagicdesign.com/de/support, um sicherzustellen, dass Sie im Besitz der aktuellsten Version sind.

Installation unter macOS:

Öffnen Sie die mitgelieferte SD-Karte oder laden Sie das Disk-Image herunter und führen Sie auf dem Installations-Icon von SmartView einen Doppelklick aus. In Ihrem Programme-Ordner wird daraufhin ein Ordner mit dem Namen „SmartView“ erstellt. Dieser enthält die Blackmagic SmartView Setup Software, ein Deinstallationsprogramm zum Entfernen älterer Versionen im Falle einer Aktualisierung und einen Dokumente-Ordner mit diesem Handbuch sowie anderen Informationen zum SmartView.

Installation unter Windows:

Öffnen Sie auf Ihrem Windows-Computer die mitgelieferte SD-Karte oder die heruntergeladene ZIP-Datei und führen Sie auf dem Installations-Icon von SmartView einen Doppelklick aus. Folgen Sie den Bildschirmanweisungen zur Fertigstellung der Installation.

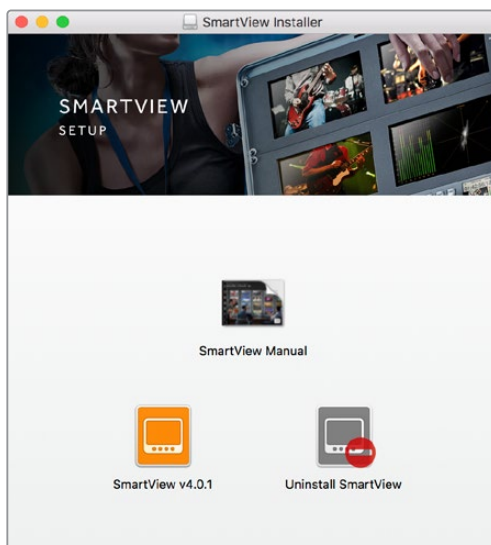

Öffnen Sie zur Installation unter macOS die Datei SmartView.dmg von der mitgelieferten SD-Karte oder in Ihrem Downloads-Ordner und klicken Sie anschließend auf das Installations-Icon von SmartView

Blackmagic SmartView Setup im Einsatz

Aktualisieren der Software

Ist Blackmagic SmartView Setup installiert und gestartet, klicken Sie auf das Einstellungs-Icon unterhalb des Monitornamens. Sie werden ggf. aufgefordert, die Produktsoftware Ihres SmartView oder SmartScope zu aktualisieren. Das geht so:

- 1 Verbinden Sie Ihren SmartView oder SmartScope per USB-Kabel oder Ethernet mit Ihrem Computer und starten Sie Blackmagic SmartView Setup.
- 2 Sollten Sie aufgefordert werden, die Produktsoftware zu aktualisieren, klicken Sie auf „Update“. Der Aktualisierungsvorgang kann ca. 5 Minuten dauern.
- 3 Die Meldung „This SmartView has been updated“ sollte im Anschluss an die abgeschlossene Aktualisierung erscheinen.
- 4 Klicken Sie zum Schließen auf „Close“.

Ist keine Aktualisierung der Produktsoftware notwendig, öffnet sich Blackmagic SmartView Setup und es erscheint die Einstellungsseite für Ihren Monitor.

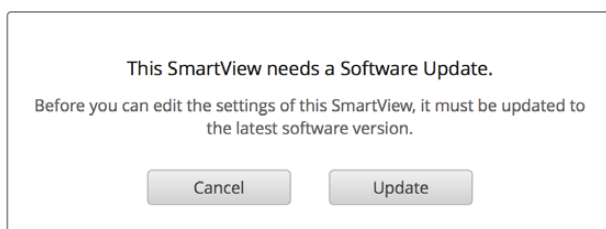

Wenn Sie SmartView Setup starten und auf das Einstellungs-Icon eines angeschlossenen SmartView oder SmartScope klicken, erscheint diese Meldung, sollte eine Softwareaktualisierung erforderlich sein

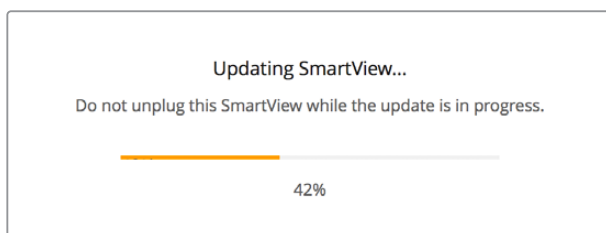

Der Aktualisierungsvorgang dauert ca. 5 Minuten

Anpassen der Monitoreinstellungen

Blackmagic SmartView Setup sucht bei jedem Start sofort nach verbundenen SmartView oder SmartScope Einheiten, die per USB oder Ethernet verbunden sind. Diese werden dann auf der Homepage von SmartView Setup angezeigt. Sollten Sie mehr als einen Blackmagic Monitor in Ihr Netzwerk eingebunden haben, selektieren Sie den Monitor, dessen Einstellungen Sie anpassen möchten, indem Sie auf den Links- oder Rechtspfeil seitlich der Homepage klicken. Ist Ihr Blackmagic Monitor per USB verbunden, erscheint ein USB-Icon neben dem Monitornamen.

Wählen Sie zum Anpassen der Einstellungen Ihren per Ethernet oder USB verbundenen Monitor aus und klicken Sie auf das Einstellungs-Icon unter dem Monitornamen. Dadurch öffnet sich die Einstellungsseite des ausgewählten Monitors. Haben Sie die Einstellungen nach Ihren Bedürfnissen angepasst, klicken Sie auf „Save“, um Ihre Einstellungen zu speichern und zur SmartView Setup Homepage zurückzukehren.

Im nächsten Abschnitt erfahren Sie mehr über die für Blackmagic Monitore verfügbaren Einstellungen und wie Sie diese anwenden. Weitere Informationen zur Konfiguration von Netzwerkeinstellungen mithilfe von SmartView Setup finden Sie im Kapitel „Anpassen von Netzwerkeinstellungen“.

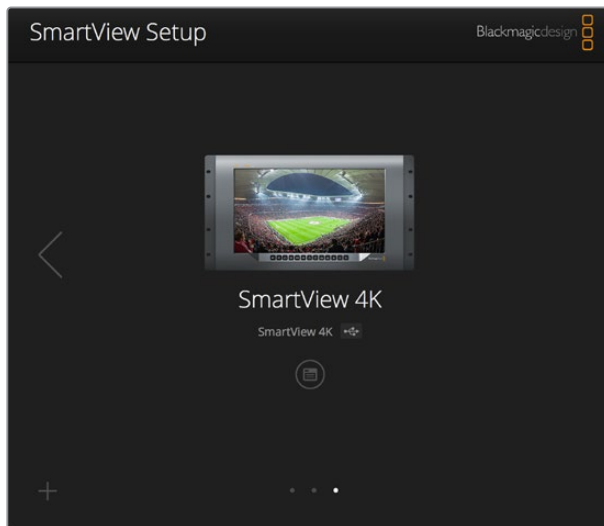

Blackmagic SmartView Setup sucht automatisch nach lokal per USB angeschlossen oder per Netzwerk eingebundenen SmartView und SmartScope Einheiten. Vergewissern Sie sich bei der Aktualisierung der Produktsoftware Ihres Monitors, dass dieser per USB oder Ethernet verbunden ist. Ein USB-Icon erscheint dann neben dem Monitornamen.

Monitoreinstellungen

Um die Einstellungen und Displays eines jeden Monitors anzupassen, müssen diese per Ethernet oder USB angeschlossen sein. Wählen Sie den einzustellenden Monitor aus, indem Sie auf der SmartView Setup Homepage auf den Links- bzw. Rechtspfeil und anschließend auf das Einstellungs-Icon unter dem Monitornamen klicken. Die Einstellungsseite zeigt jeweils die von Ihrem ausgewählten Blackmagic Monitor unterstützten Funktionen an.

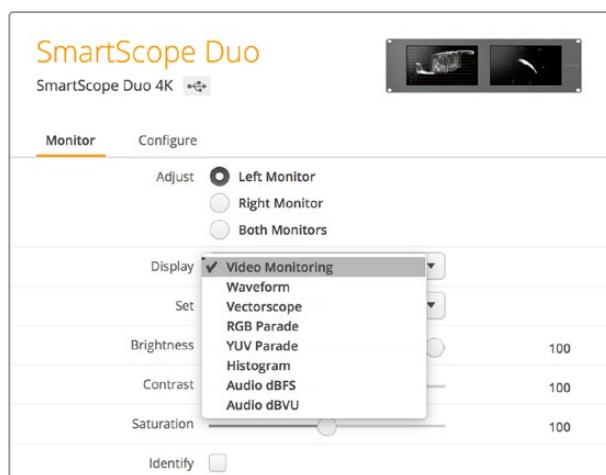

Beim SmartScope können Sie im Drop-down-Menü „Display“ zwischen den Optionen „Scopes“ und „Video Monitoring“ wählen

Adjust

Bei einem SmartScope bzw. SmartView Duo legen Sie hiermit fest, welchen Monitor Sie anpassen können. Wählen Sie für den linken Monitor, „Left Monitor“, für den rechten „Right Monitor“ oder für beide Monitore „Both Monitors“ aus. Wenn die Option „Both Monitors“ aktiviert ist, werden jegliche Anpassungen hinsichtlich Helligkeit, Kontrast und Sättigung auf beide Monitore des SmartView Duo bzw. SmartScope Duo angewandt.

Display

Bei Einsatz eines SmartScope zeigt das Drop-down-Menü „Display“ auswählbare Scopes an. Wählen Sie die Option „Video Monitoring“, wenn Sie das Videobild angezeigt bekommen wollen.

Set

Wenn Sie beim SmartScope die Display-Option „Video Monitoring“ vorgegeben haben, können Sie für SD-Video im Drop-down-Menü „Set“ zwischen den Bildseitenverhältnissen „SD Aspect to 4:3“ oder „SD Aspect to 16:9“ wählen. Das Drop-down-Menü „Set“ bietet darüber hinaus zusätzliche Optionen für das ausgewählte Display an, darunter „Vectorscope“, „Audio dBFS“ und „Audio dBVU“.

- **Video Monitoring:** Wählen Sie diese Option, um das Videobild im 4:3- oder 16:9-Seitenverhältnis anzuzeigen.
Bei anamorphotischem SD-Video im Breitbildformat, wählen Sie das 16:9-Seitenverhältnis. Bei traditionellem 4:3-Video in Standard Definition, wählen Sie das 4:3-Seitenverhältnis.
- **Vectorscope:** Geben Sie vor, ob Ihre Eingabe auf Farbbalken-Testsignalen von 100 % oder 75 % basiert.
- **Audio dBFS:** Wählen Sie das Audiokanalpaar, dessen Phasen Sie überprüfen möchten.
- **Audio dBVU:** Wählen Sie das Audiokanalpaar, dessen Phasen Sie überprüfen möchten.

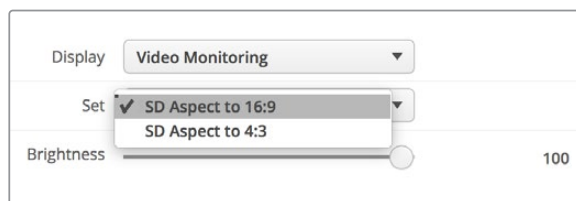

Wählen Sie „SD Aspect to 16:9“ für anamorphotisches Standard-Definition-Video

Brightness, Contrast, Saturation

Passen Sie mit diesen Schiebereglern Helligkeit, Kontrast und Sättigung an. Die verfügbaren Einstellungen unterscheiden sich je nach SmartView und SmartScope Modell.

Identify

Ist das Kontrollkästchen „Identify“ mit einem Häkchen aktiviert, wird das Display des derzeit in Blackmagic SmartView Setup ausgewählten Monitors weiß umrandet. Bei mehreren angeschlossenen SmartView und SmartScope Einheiten, lässt sich der ausgewählte Monitor so leicht visuell identifizieren.

Ist das Kontrollkästchen zusammen mit der Option „Both Monitors“ aktiviert, erscheint die weiße Umrandung auf den Displays beider SmartView Duo oder SmartScope Duo 4K Monitore.

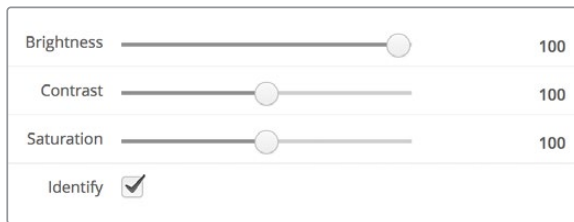

Ziehen Sie die Schieberegler nach links oder rechts, um die Einstellungen für Helligkeit, Kontrast und Sättigung anzupassen. Setzen Sie im Kontrollkästchen „Identify“ ein Häkchen, um den ausgewählten Monitor zu markieren

Enable Tally Override

Wählen Sie beim Blackmagic SmartView 4K „Enable tally override“, um Tally-Umrandungen zu aktivieren. Diese Funktion wird auf Blackmagic URSA Mini Pro 4.6K und Blackmagic URSA Broadcast Kameras unterstützt.

Verbinden Sie dazu den SDI-Ausgang der Kamera mit dem SDI-Eingang („SDI In“) A oder B Ihres SmartView 4K und den Programmausgang des ATEM Mischers mit dem SDI-Eingang der Kamera.

Wird die Kamera mittels des ATEM Mischers auf die Programmausgabe umgeschaltet, erscheint auf Ihrem SmartView 4K eine rote Tally-Umrandung. Wird auf die Vorschauausgabe umgeschaltet, erscheint eine grüne Tally-Umrandung.

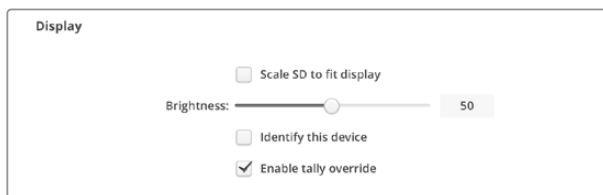

Aktivieren Sie das Kontrollkästchen „Enable tally override“, um Tally-Umrandungen auf einem an Blackmagic URSA Mini Pro oder URSA Broadcast Kameras angeschlossenen SmartView 4K anzuzeigen

Der SmartView 4K im Einsatz

Der Blackmagic SmartView 4K

Der SmartView 4K ist ein 6 HE großer Broadcastmonitor mit 12G-SDI zur Darstellung von SD-, HD- und sogar Ultra-HD-Video in nativem 2160p/60. Mit seinem hellen Display und breiten Betrachtungswinkel sorgt er für lebhaftere, kristallklare Bilder für akkurates Fokus- und Farbmonitoring. Darüber hinaus unterstützt er praktisch jedes Videoformat.

Der SmartView 4K wurde sowohl fürs Studio als auch fürs Field-Broadcasting konzipiert und ist leicht zu bedienen. Dank der seitlich angebrachten Anschlüsse und seiner VESA-Konformität findet der Monitor auch auf beengtem Raum Platz. Alternativ lässt er sich an eine Wand montieren oder an einer schwenkbaren Halterung befestigen. Der SmartView 4K lässt sich über das integrierte Bedienfeld steuern. An Standorten, die keinen Zugang zum Frontbedienfeld gewähren, kann er auch per Ethernet aus der Ferne gesteuert werden.

Zwei Multi-Rate-12G-SDI-Eingänge lassen Sie zwischen zwei SDI-Quellen wählen. Außerdem gibt es einen SMPTE-konformen SFP-Modul-Käfig zum Anschließen eines SDI-Glasfasermoduls, damit Sie Ihr Video per Glasfaser verbinden können. Über den 12G-SDI-Ausgang können Sie Ihre Videosignale an anderes Equipment weiterleiten. Zwei Ethernet-Anschlüsse dienen indes zur Netzwerkeinbindung, zur Fernsteuerung sowie als Durchschleifausgang bei der Reihenschaltung mehrerer Monitore. Zu den übrigen Anschlüssen zählen ein Tally-Eingang für Live-Produktionen und ein USB-Port für Aktualisierungen der Produktsoftware.

Mithilfe der Blackmagic SmartView Setup Software lassen sich sogar branchenübliche 3D-LUTs mit der Dateierweiterung .cube oder auch in DaVinci Resolve generierte LUTs laden. Wenn Sie Ihren SmartView 4K direkt an Ihre Kamera anschließen, können Sie Ihre Clips dank der LUT im gewünschten Look sichten. Mit zwei Schärfestufen für Focus Peaking gehen Sie sicher, dass Ihre Einstellungen immer perfekt fokussiert sind. Und aufgrund der Unterstützung für AC- sowie DC-Strom bleibt es Ihnen überlassen, ob Sie den SmartView 4K per Netzstrom oder – wenn Sie am Set frei beweglich bleiben möchten – per externem Akku betreiben.

Der SmartView 4K ist die perfekte Monitoring-Lösung für Broadcastproduktionen, ob unterwegs oder im Studio. Er zeigt Video in SD, HD und Ultra HD in nativer 3840 x 2160 Pixelauflösung an.



HINWEIS Sollten Sie eine externe Stromquelle über den DC-Eingang anschließen, vergewissern Sie sich, dass der Stromausgang dieser Quelle 24 Watt bei 12 Volt speist.

Bedientasten

Das Bedienfeld verfügt über eine Reihe Tasten, mit denen Sie Einstellungen an Ihrem SmartView 4K im Handumdrehen ändern können.

INPUT

Mit dieser Taste durchlaufen Sie alle Videosignale, die über die 12G-SDI-Eingänge bzw. den optionalen SFP-Glasfaseranschluss an Ihren SmartView 4K gekoppelt sind. Liegt an einem Eingang kein Videosignal vor, zeigt der SmartView 4K für diesen Eingang schwarzen Bildinhalt an. Wenn Sie zwischen Eingängen hin und her schalten, werden in der linken oberen Monitorecke kurzzeitig Informationen zum Eingabeformat angezeigt.

DISP

Mit der DISP-Taste passen Sie die Helligkeit des LCDs Ihres SmartView 4K an. Stellen Sie die Helligkeit anhand der Aufwärts- und Abwärtspeile nach Bedarf ein. Drücken Sie erneut auf DISP, um die Einstellung zu schließen.

H/V DELAY

Anhand der Taste H/V DELAY lässt sich das Vorhandensein eingebetteter Zusatzdaten in Ihrem SDI-Videosignal ruckzuck überprüfen. Beispiel: Drücken Sie die H/V-DELAY-Taste einmal, um horizontale Zusatzdaten anzuzeigen. Drücken Sie die Taste erneut, um vertikale Zusatzdaten anzuzeigen. Dabei handelt es sich oft um häufig verwendete Daten wie bspw. geschlossene Untertitel.

BLUE ONLY

Ist in einem digitalen Videosignal Bildrauschen vorhanden, tritt es am stärksten im blauen Kanal auf. Dieses Bildrauschen im blauen Kanal lässt sich anhand der BLUE-ONLY-Taste überprüfen. Daraufhin wird lediglich der blaue Kanal in Form eines Schwarzweißbilds angezeigt. Das Schwarzweißbild können Sie auch als Hilfe beim Kontrollieren der Kamerafokussierung verwenden.

ZOOM

Gestochen scharfe Bilder durch exakten Kamerafokus erzielen Sie mit der ZOOM-Taste. Drücken Sie die Taste einmal, um in das Bild hineinzuzoomen. Nun können Sie ganz klar sehen, ob ein Objekt scharf fokussiert ist. Drücken Sie die ZOOM-Taste erneut, um zur normalen Ansicht zurückzukehren.

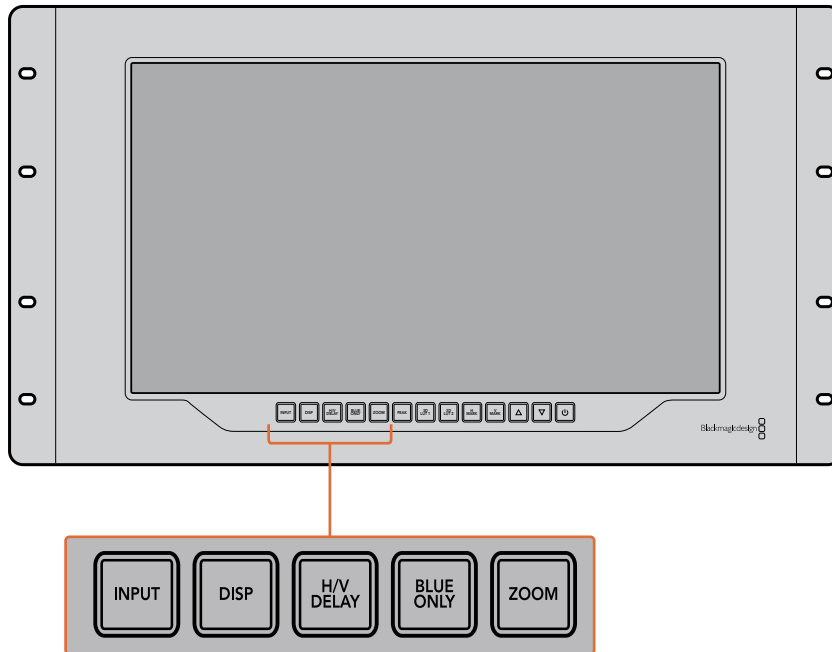

PEAK

Der Kamerafokus lässt sich ganz leicht überprüfen, indem Sie die PEAK-Taste drücken und damit Focus Peaking aktivieren. Dadurch wird eine grüne Markierung um die schärfsten Bereiche Ihres Bilds herum eingeblendet. Es stehen zwei Schärfestufen für Peaking zur Verfügung. Wechseln Sie durch mehrmaliges Drücken zwischen den unterschiedlichen Einstellungen hin und her. Sobald die grünen Markierungen am stärksten sind, wissen Sie, dass Ihre Kamera fokussiert hat.

3D LUT 1 und 3D LUT 2

Mithilfe der LUT-Tasten können Sie Ihr Videobild mit LUTs anzeigen lassen. Das funktioniert sowohl mit LUTs, die Sie selbst in Blackmagic DaVinci Resolve erstellt haben, als auch mit branchenüblichen .cube-LUTs. Drücken Sie eine der LUT-Tasten, um die jeweilige LUT zu aktivieren. Drücken Sie die Taste erneut, um die LUT zu deaktivieren. Weitere Informationen zur Verwendung von 3D-LUTs auf dem SmartView 4K finden Sie im Abschnitt „3D-LUTs mit Blackmagic SmartView Setup laden“.

H MARK und V MARK

Mit den Tasten H MARK und V MARK können Sie Bildrandmarkierungen anzeigen und bearbeiten. Bildrandmarkierungen unterstützen Sie bei der Komposition von Einstellungen und helfen dabei, Informationen und Grafiken innerhalb des Schutzbereiches auf dem Bildschirm anzuzeigen. Je nach Größe des Fernsehers wird mal mehr und mal weniger von den Kantenbereichen des Videosignals wiedergegeben. Daher ist es praktisch, sich einen Schutzbereich anzeigen zu lassen. Beim Schutzbereich handelt es sich um den Bereich des Bildschirms, der immer sichtbar ist, unabhängig vom Modell des Fernsehers bzw. Monitors.

Um horizontale und vertikale Bildrandmarkierungen anzuzeigen, drücken Sie die entsprechende Taste, also H MARK oder V MARK. Wenn Sie die Markierung anpassen wollen, drücken Sie die jeweilige Taste erneut. Dadurch wird die entsprechende Markierung hervorgehoben. Mithilfe der Pfeiltasten lässt sich nun die Position der Markierungen anpassen. Ein erneutes Drücken der jeweiligen Taste bestätigt die neue Position. Mit einem weiteren Druck auf die Taste wird die Markierung deaktiviert.

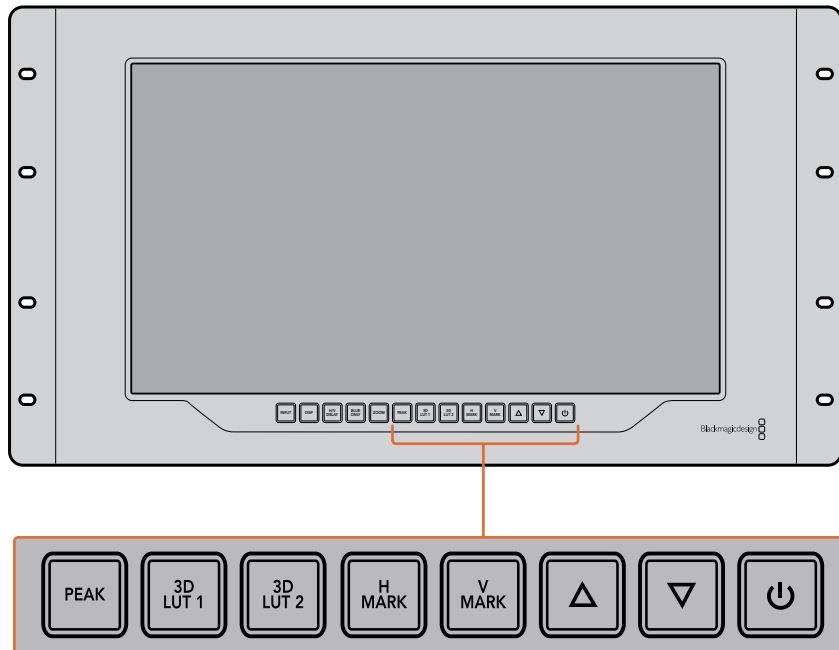

Pfeiltasten

Passen Sie Einstellungen wie bspw. die Display-Helligkeit oder Bildrandmarkierungen mithilfe der Auf- und Abwärtspfeiltasten an.

Ein-/Austaste

Drücken Sie die Ein- und Ausschalttaste einmal, um Ihren SmartView 4K einzuschalten. Drücken Sie sie erneut, um ihn auszuschalten.

3D-LUTs mit Blackmagic SmartView Setup laden

Mit dem SmartView 4K können Sie Ihr Video mit angewandten 3D-LUTs überprüfen. Somit haben Sie die Möglichkeit, Ihren SmartView 4K anhand von professionellen LUTs zu kalibrieren oder Ihr Video im angestrebten Look zu sichten. Darüber hinaus können Sie mit unterschiedlichen Looks herumexperimentieren. LUTs werden über die Blackmagic SmartView Setup Software auf den SmartView 4K geladen. Da der SmartView 4K branchenübliche LUT-Dateien mit der Erweiterung .cube unterstützt, können Sie sogar eigens in Blackmagic DaVinci Resolve erstellte LUTs verwenden. Details zur Erstellung von LUT-Dateien finden Sie im englischsprachigen DaVinci Resolve Handbuch.

So belegen Sie die Taste 3D LUT 1 mit einer 3D-LUT:

- 1 Starten Sie Blackmagic SmartView Setup.
- 2 Klicken Sie auf den „Load“-Button neben „Load LUT 1“. Es öffnet sich ein Fenster, das nach dem Pfad der zu ladenden LUT-Datei fragt. Wählen Sie die gewünschte .cube-LUT-Datei aus und öffnen Sie sie mit „Open“.
- 3 Um die soeben geladene LUT zu sichten, drücken Sie die Taste 3D LUT 1 auf dem SmartView 4K Bedienfeld. Drücken Sie die Taste erneut, um die LUT zu deaktivieren.

Folgen Sie denselben Schritten, um die Taste 3D LUT 2 mit einer LUT zu belegen.

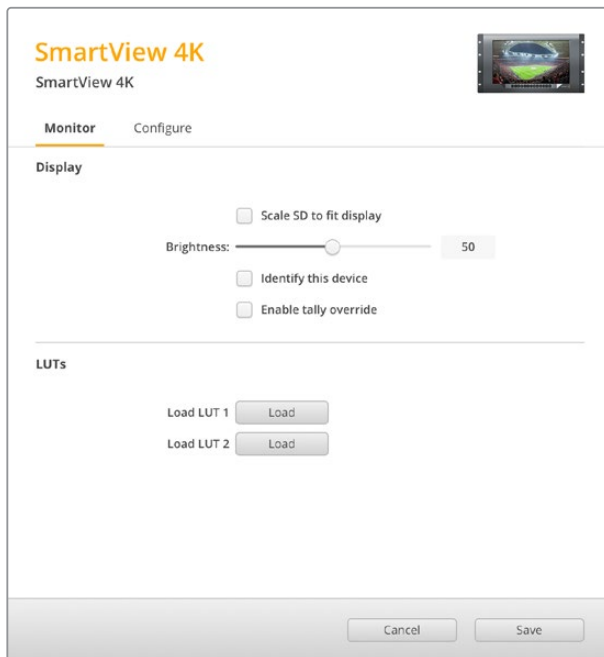

Laden Sie 3D-LUTs mithilfe von Blackmagic SmartView Setup auf Ihren SmartView 4K

Der SmartScope Duo 4K im Einsatz

Was ist der Blackmagic SmartScope?

Früher waren in der TV- und Postproduktion eingesetzte Messgeräte für Bild und Ton von Broadcastqualität unglaublich kostspielige Maßlösungen. Trotzdem konnte jeweils nur eine einzige Messanzeige auf einem winzigen Bildschirm angezeigt werden. Manche dieser Messgeräte sahen geradezu unattraktiv aus und machten vor Kunden keinen guten Eindruck.

Mit dem SmartScope Duo 4K bekommen Sie zusätzlich zur Bildkontrolle die Funktionen eines Waveform-Monitors. Behalten Sie so alle Aspekte Ihres Videosignals auf beiden Bildschirmen echtzeitbasiert im Auge. Jegliche Änderungen am Eingangssignal in Blackmagic SmartView Setup werden sofort auf dem SmartScope Duo 4K sichtbar. Jedes Eingangssignal kann über den Durchschleifausgang an einen beliebigen der beiden Monitore gesendet werden. So können Sie z. B. auf dem rechten Monitor ein Scope für das Videosignal des linken Monitors anzeigen.

Die Auswahl der jeweils auf dem SmartScope Duo 4K angezeigten Messanzeige wird in Blackmagic SmartView Setup ausgewählt. Wählen Sie Ihr Scope aus dem Drop-down-Menü „Display“ aus.

Auf den folgenden Seiten erfahren Sie, wie die einzelnen Messanzeigen anzuwenden sind, damit Sie einen Einblick bekommen, inwieweit die Anzeigen Ihnen helfen können.

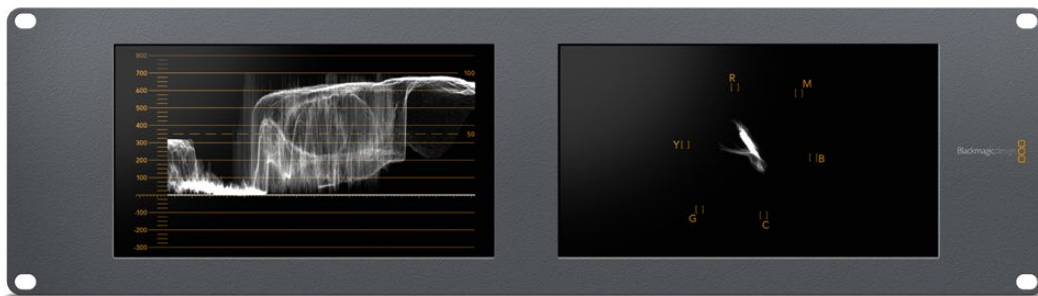

Mithilfe von Blackmagic SmartView Setup lassen sich jedem der beiden Monitore unterschiedliche Scopes zuweisen

Die Video-Monitoring-Anzeige

Die Video-Monitoring-Anzeige stellt das vom SmartScope empfangene Videobild dar und gibt Ihnen beim Monitoring eine praktische visuelle Referenz.

Liegt Ihr Eingangssignal in SD vor, können Sie im Drop-down-Menü „Set“ zwischen den Ansichtsmodi „SD Aspect to 4:3“ oder „SD Aspect to 16:9“ wählen. An der LCD-Helligkeit, den Kontrast- oder Sättigungseinstellungen vorgenommene Änderungen werden in der Ansicht sofort sichtbar. Bitte beachten Sie, dass sich diese Änderungen lediglich auf das Monitorbild auswirken, nicht auf das Videosignal. Aus diesem Grund können Änderungen hinsichtlich Sättigung oder Helligkeit in den Scopes nicht nachvollzogen werden.

Oft ist es hilfreich, einen Bildschirm als Video-Monitoring-Anzeige und den anderen als Scope zu nutzen. Verbinden Sie hierzu mit einem kurzen Kabel den SDI-Durchschleifausgang von Monitor 1 mit dem SDI-Eingang von Monitor 2.

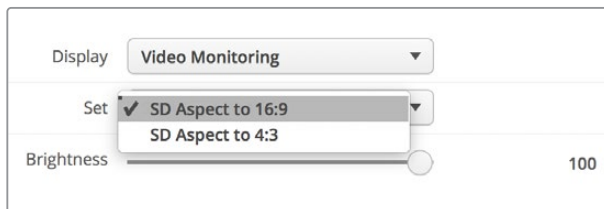

Lassen Sie sich SD-Video im 4:3-Pillarbox- oder 16:9-Breitbildformat anzeigen, indem Sie die gewünschte Option im „Set“-Menü in Blackmagic SmartView Setup wählen. Wählen Sie für anamorphotisches Video in Standard Definition „SD Aspect to 16:9“

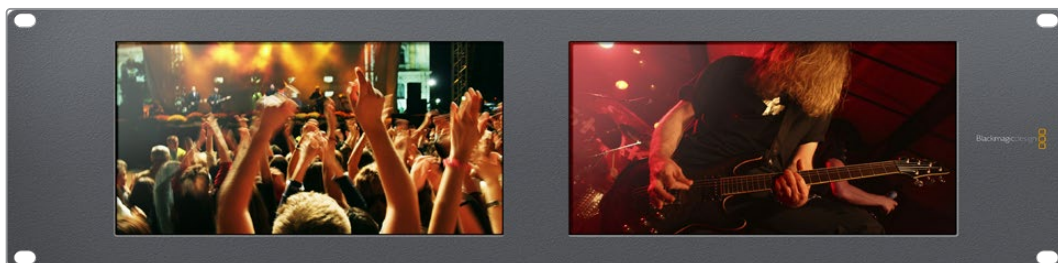

Die Video-Monitoring-Anzeige zeigt das Videosignal so an, wie es auf einem Fernseher oder Monitor erscheinen würde

Waveform-Anzeige

Die Waveform-Anzeige liefert eine digital kodierte Wellenform, die denen herkömmlicher Waveform-Monitore für Luminanz ähnelt. Sie wird genutzt, um die Luma- bzw. Helligkeitspegel Ihres Videosignals zu kontrollieren und anzupassen.

Herkömmliche Luminanz-Waveform-Monitore unterstützen nur analoges FBAS-Video in Standard Definition. Der Waveform-Monitor des SmartScope Duo 4K funktioniert hingegen auch in Ultra HD, HD und in SD. So sind Lumapegel auch beim Monitoring digitaler Videoformate in High Definition durchgängig und mühelos anpassbar.

Wählen Sie in Blackmagic SmartView Setup im Drop-down-Menü „Display“ die Option „Waveform“ aus. Vergewissern Sie sich, dass die Schwarztöne im Kurvenverlauf nicht unter 0 % und die Weißtöne nicht über 100 % liegen. Andernfalls geraten Ihre Lumawerte in den unzulässigen Bereich.

Der Waveform-Monitor zeigt eine grafische Repräsentation des Videobilds an, die die Lumawerte entsprechend der Position innerhalb eines Bilds darstellt. Ist bspw. ein Teil des Himmels überbelichtet, sehen Sie dies in der Waveform-Anzeige in derselben horizontalen Position, in der sich die Überbelichtung auch im Einzelbild befindet.

Der Kurvenverlauf ändert sich je nach Bildinhalt. Wenn Sie kontrastreiche Videobilder kontrollieren, kann es sein, dass in den mittleren Graubereichen keine Werte vorhanden sind. Das Bild unten zeigt den Kurvenverlauf eines gleichmäßig belichteten Bilds an, mit einem dunklen Fleck auf der linken Seite und helleren Werten, die sich von der Mitte des Bilds zur rechten Seite hinziehen.

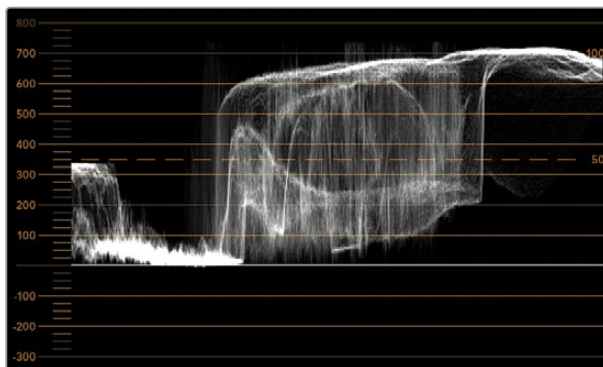

Ein Luminanzwerte darstellender Kurvenverlauf

Adjust	<input checked="" type="radio"/> Left Monitor
	<input type="radio"/> Right Monitor
	<input type="radio"/> Both Monitors
Display	Waveform ▼
Set	No Options ▼

Wählen Sie in Blackmagic SmartView Setup in den „Display“-Einstellungen die Option „Waveform“ aus, um die Luminanzwerte Ihres Videosignals anzuzeigen

Vektorskop-Anzeige

Die Vektorskop-Anzeige veranschaulicht die in einem Videosignal enthaltenen Farben anhand eines Vektors. Wählen Sie je nach Norm der in Ihrer Sendeanstalt eingesetzten Farbbalken-Testsignale in Blackmagic SmartView Setup aus dem Drop-down-Menü „Set“ einfach die Option „100 %“ oder „75 %“.

Viele Benutzer glauben, dass sich mit einer Vektorskop-Anzeige unzulässige Pegel kontrollieren lassen. Das ist jedoch nicht richtig. Nicht konforme Farben prüft man mit der RGB-Parade-Anzeige. Für die Prüfung unzulässiger Pegel verbietet sich der Einsatz eines Vektorskops, da neben Chromawerten außerdem Helligkeitswerte nötig sind. Beispielsweise können Farbwerte in der Nähe des Weiß- oder Schwarzpunkts im Video nicht so stark gesättigt sein, wie die viel stärkeren Farben in den mittleren Farbbereichen. Da die Vektorskop-Anzeige ausschließlich Farben, aber keine Helligkeitswerte anzeigt, ist sie für die ausschließliche Prüfung unzulässiger Farben nicht geeignet.

Am besten eignet sich die Vektorskop-Anzeige, um die Farbpegel älterer, analoger Videobänder zu prüfen, deren Chromawerte anzupassen sind. Spielen Sie einfach das Farbbalken-Segment des Videobands ab und passen Sie dann die Chroma- und Farbtoneinstellungen an, sodass die Farben des Videos in die rechteckigen Boxen der Markierung fallen.

Die Vektorskop-Anzeige bietet sich auch für die Farbkorrektur an, weil leicht erkennbar ist, ob der Weißabgleich Ihres Videos stimmt oder ob es einen Farbstich hat. Sollte Ihr Video einen Farbstich haben, erscheint die Vektorskop-Darstellung nicht mittig und Sie sehen ggf. zwei Punkte in der Mitte. Normalerweise entsteht durch die Austastung im Videosignal ein Punkt in der Mitte des Vektorskops. Dem ist so, weil die Austastlücke aus schwarzem Bildinhalt besteht. Austastlücken geben einen nützlichen Anhaltspunkt und lassen schwarze Videobereiche ohne jegliche Farbinformationen erkennen.

Weist Ihr Video einen Farbstich auf, sollte zu beobachten sein, dass sich die Schattenwerte von den Farben und aus der Mitte entfernen. Der Verschiebungswinkel stellt den Grad des Farbstichs in Ihrem Video dar. Die Verschiebung ist in den weißen und den schwarzen Details Ihres Videos sichtbar. Aus diesem Grund ist die Vektorskop-Anzeige ein nützliches Werkzeug, um Farbstiche zu entfernen und den korrekten Weißabgleich wiederherzustellen.

Mithilfe der Vektorskop-Anzeige können Sie die Farben in Ihrem Video bis an die Grenzen ausreizen, ohne dabei den Schwarz- und Weißstönen versehentlich ungewollte Farbstiche zu verleihen. Der Weißabgleich lässt sich zwar ebenso mit der RGB-Parade wie mit dem Vektorskop prüfen, etwaige Probleme sind in der Vektorskop-Anzeige jedoch oftmals leichter erkennbar.

Für Farbkorrekturen an Bildmaterial mit Hauttönen empfiehlt es sich, die Sättigung der warmen Farben auf dem Vektorskop entlang des feinen, diagonalen Strichs bei ca. 10 Uhr zu konzentrieren. Da die sogenannte Hauttonlinie sich nach der typischen Farbe von Blut an der Hautoberfläche richtet, gilt sie für alle Hautpigmentierungen. Deshalb gibt es keine bessere Methode, um die Hautfarbe Ihrer Darsteller natürlich erscheinen zu lassen.

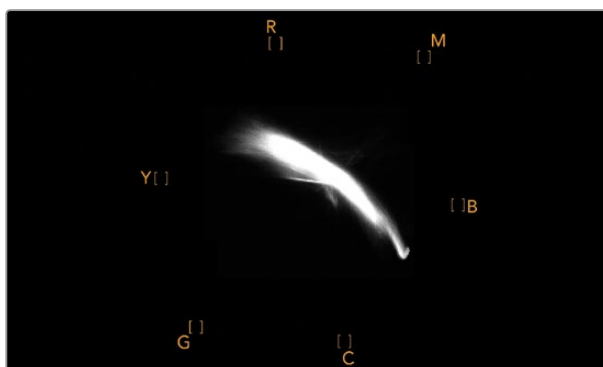

Vektorskop, das die Hauttonlinie nahe der 10-Uhr-Position anzeigt

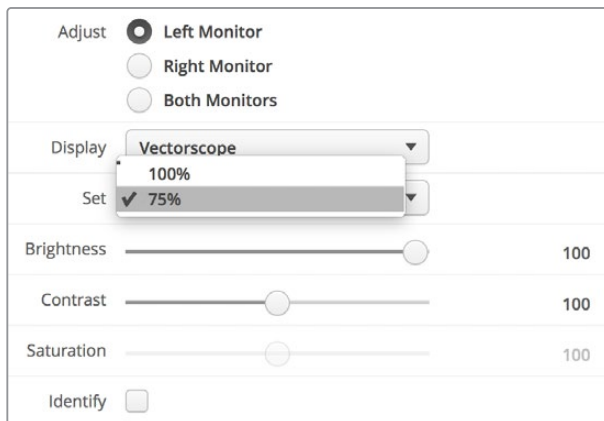

Stellen Sie Ihr Vektorskop auf ein Farbbalken-Testsignal von 100 % oder 75 % ein

Parade-Anzeige

RGB- und YUV-Parade-Anzeigen eignen sich perfekt für die Farbkorrektur, zur Kontrolle unzulässiger Farben und zur Überprüfung von Pegeln.

Wählen Sie bei der Farbkorrektur in Blackmagic SmartView Setup im Drop-down-Menü „Display“ die Option „RGB Parade“ aus. Die RGB-Parade stellt die gesamte Höhe des roten, grünen und blauen Farbkanals dar. Die Kontrolle der Pegel eines jeden Farbkanals vereinfacht die Farbkorrektur und macht es leicht, die Farbbalance des Videosignals in den dunklen, mittleren und hellen Bereichen auszugleichen. Die RGB-Parade-Anzeige ermöglicht es Ihnen, gemeinsame Komponenten des roten, grünen und blauen Farbkanals zu identifizieren. Das erleichtert den Farbabgleich und das Entfernen unerwünschter Farbstiche.

Bei der Farbkorrektur ist es wichtig sicherzugehen, dass die Videopegel zwar voll ausschlagen, jedoch nicht abgeschnitten werden. Achten Sie beim Anheben des Videopegels darauf, dass er die obere RGB-Grenze nicht überschreitet, da dies zu nicht konformen Pegeln führt. Manche Geräte lassen Sie keine unzulässigen 100%-RGB-Pegel generieren, andere jedoch schon. Auf dem SmartScope Duo 4K können Sie auftretende unzulässige Videopegel sofort sehen.

Unzulässige Videopegel können ebenso in den Schwarz- wie auch in den Weißwerten vorkommen. In einigen Farbkorrektursystemen können die Schwarzwerte unter den Schwarzpunkt von 0 % gesenkt werden. Wenn Sie ungültige Schwarzwerte feststellen, heben Sie lediglich Lift oder Gain an. Prüfen Sie dabei jedoch die 100%-Marke des Gitternetzes und vergewissern Sie sich, dass das gesamte Videosignal nicht übermäßig geliftet wurde und nun ungültige Farben in den hellen Bereichen auftreten.

Um die YUV-Pegel zu überprüfen, wählen Sie im Drop-down-Menü „Display“ die Option „YUV Parade“ aus. Diese Ansicht ist hilfreich, weil die Lumawerte für die Helligkeit von den Chromawerten für Farben getrennt sind. Dies ist das gängige Format von Videosignalen bei Fernsehübertragungen. Der linke Kurvenverlauf bezieht sich auf die Luminanzinformationen, der zweite und dritte Kurvenverlauf auf die Chromainformationen. Die YUV-Parade eignet sich für die Kalibrierung der Chromawerte eines Videosignals gemäß eines Farbbalken-Testmusters, damit Farben akkurat repräsentiert und die übertragenen Signale von Fernsehern angezeigt werden können.

Die Farbkorrektur ist ein kontinuierlicher Anpassungsprozess, um atemberaubende Bilder zu schaffen und unzulässige Pegel zu vermeiden.

Terminologie zur Farbkorrektur

Blacks – Schwarzwerte im Videosignal

Mids – Grauwerte im Videosignal

Whites – Weißwerte im Videosignal

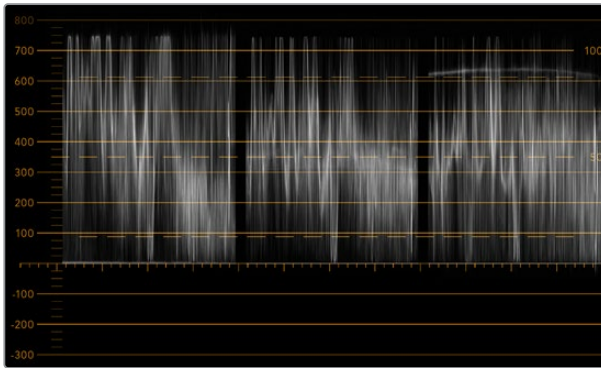

RGB-Parade-Ansicht

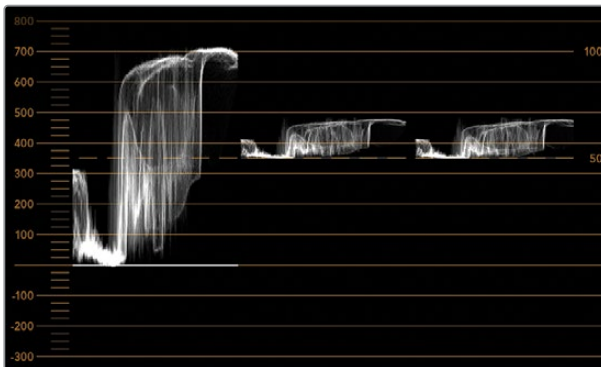

YUV-Parade-Ansicht

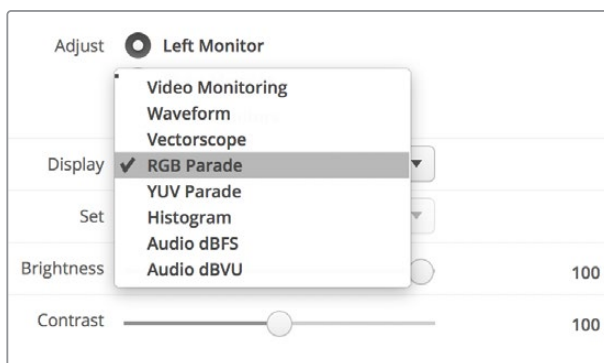

Wählen Sie in Blackmagic SmartView Setup im Drop-down-Menü „Display“ die Option „RGB Parade“ oder „YUV Parade“

Histogramm-Anzeige

Grafikdesigner und Kameralleute sind mit der Histogramm-Anzeige besonders vertraut.

Die Histogramm-Anzeige stellt die Verteilung der weißen und schwarzen Bildinformationen dar und lässt Sie kontrollieren, wie nahe diese Details an die Überpegel in den hellen und dunklen Bereichen

heranreichen, die abgeschnitten werden. Die Histogramm-Anzeige stellt auch dar, wie sich in den mittelhellen Bildpartien Ihres Videos, dem sogenannten Gamma-Bereich, vorgenommene Änderungen auswirken.

Schwarzwerte werden auf der linken Seite der Anzeige dargestellt und Weißwerte auf der rechten Seite. Normalerweise sollten alle Videosignale im Bereich der Intervalle von 0–100 % der Histogramm-Anzeige liegen. Videopegel unter 0 % oder über 100 % werden abgeschnitten. Während eines Drehs kann es zu übermäßigem Abschneiden von Videoüberpegeln, dem sogenannten Clipping, kommen. Für spätere Farbkorrekturen in kontrollierter Umgebung müssen die Details in den schwarzen und weißen Partien jedoch erhalten werden. Halten Sie Ihre Videopegel beim Filmen über der schwarzen und unter der weißen Clipping-Grenze. So haben Sie später ausreichend Spielraum bei der Farbanpassung, ohne dass die weißen und schwarzen Bereiche dabei zu kontrast- oder detailarm wirken.

Vielleicht beschließen Sie bei der Farbkorrektur, Ihr Video in die Überpegel ausschlagen zu lassen. In diesem Fall zeigt Ihnen das Histogramm den Clipping-Effekt im Video an und wie viel abgeschnitten wird. Einen ähnlichen Look mit geringeren Videoüberpegeln bei gleichzeitiger Beibehaltung von mehr Details können Sie sogar mit einer Gamma-Justage erzielen.

Zur Kontrolle unzulässiger Farbpegel ist ein Histogramm ungeeignet, es zeigt Ihnen aber unzulässige Schwarz- und Weißtöne an. Da das Histogramm keine Farben darstellt, kann die Histogramm-Anzeige den Anschein erwecken, als befänden sich die Pegel im gültigen Bereich, selbst wenn Ihr Video unzulässige Farben enthält. Vorzugsweise benutzt man auch hier die RGB-Parade, um unzulässige Pegel festzustellen, da sie sowohl die Farb- als auch die Helligkeitselemente des Videosignals anzeigt.

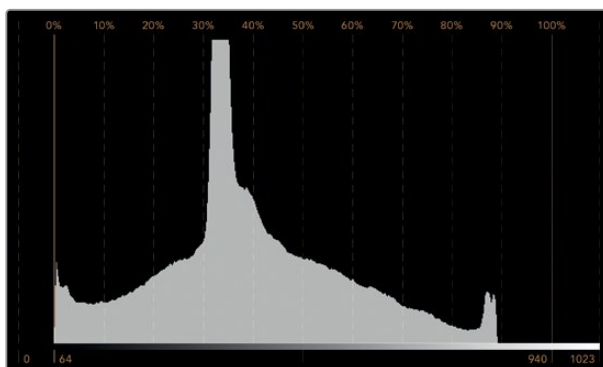

Die Histogramm-Anzeige stellt die Verteilung der Weiß- und Schwarzwerte dar

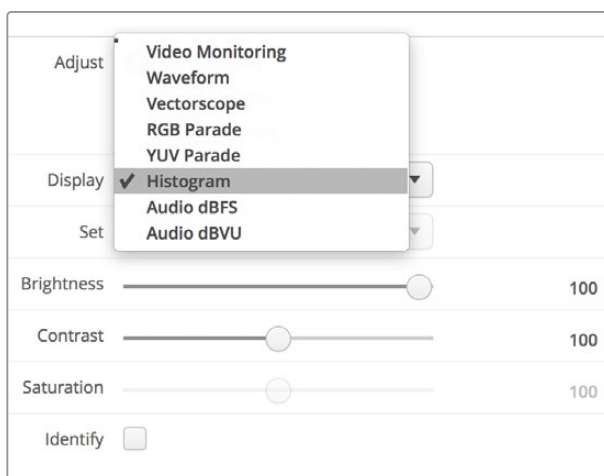

Wählen Sie in Blackmagic SmartView Setup im Drop-down-Menü „Display“ die Option „Histogramm“ aus

Audiopegelmeter-Anzeige

Die Audiopegelmeter-Anzeige stellt die Audiopegel des eingebetteten Audios im SDI-Videosignal dar. Bis zu 16 Kanäle eingebettetes Audio werden aus dem Videosignal isoliert und im dBVU- oder dBFS-Format angezeigt.

Das bei älteren Geräten sehr gebräuchliche, benutzerfreundliche VU-Meter zeigt durchschnittliche Signalpegel an. Das VU ist gemäß der SMPTE-Empfehlung mit einem auf -20 dBFS eingestellten 1 kHz-Tontestsignal kalibriert.

Die bei modernen tontechnischen Digitalgeräten gebräuchliche Einheit dBFS (vollständige Dezibelskala) bezeichnet die Angabe des absoluten Tonpegels eines digitalen Audiosignals.

Das rechte Audio-Scope kann zwei Audiokanäle überwachen. Diese können aus dem Drop-down-Menü „Set“ ausgewählt werden, z. B. „Ch 1 & 2“, „Ch 3 & 4“ usw. Das Audio-Scope stellt Audio in einer X-Y-Ansicht dar. So ist sichtbar, ob es Probleme mit der Audiobalance oder falsche Phasenlagen gibt und ob eine Audiospur in Mono oder Stereo vorliegt. Mono sollte in einer vertikalen phasenkorrekten Linie erscheinen. Wird eine horizontale Linie angezeigt, so ist Ihr Audio phasenverkehrt und könnte beim Empfang nachgeschalteter Geräte ausgelöscht werden (d. h. Verlust von Audio). In großen Sendeanstalten, wo das Risiko falsch angeschlossener Kabel besteht, zählen Audiophasenfehler zu den häufigsten Pannen.

Bei der Überwachung von Stereosignalen fächert sich die Linie des rechten Audio-Scopes aus, was den Unterschied zwischen den linken und rechten Audiokanälen verbildlicht. Je mehr Stereoton in einer Audiospur enthalten ist, desto kreisförmiger erscheint die Anzeige. Enthält das Audio minimale Stereoinhalte, konzentriert sich die Anzeige stärker um die vertikale Achse.

Dialogton erscheint eher als vertikale Linie, wohingegen Musik mit viel Stereoinhalt das Scope aufgeblasen wirken lässt. Dem ist so, weil Monoaudio L+R ist und auf der vertikalen Achse angezeigt wird. Stereoinhalte sind hingegen L-R und werden auf der horizontalen Achse angezeigt, um den Stereounterschied wiederzugeben.

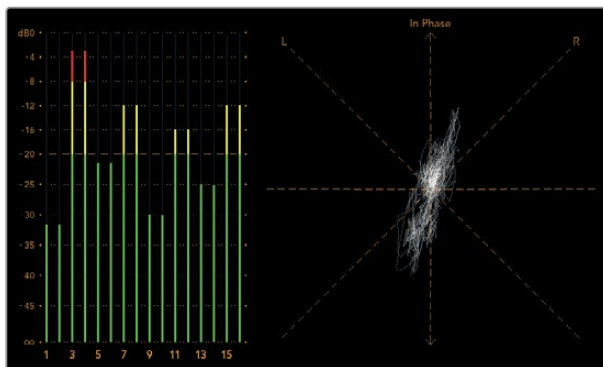

Die Audiopegelmeter-Anzeige zeigt Spitzenpegel und Audiobalance an

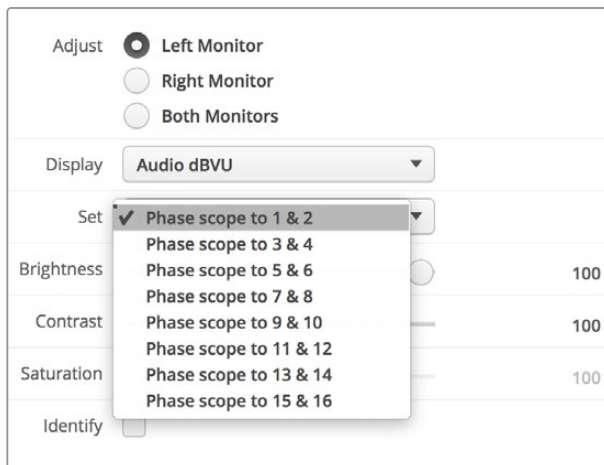

Wählen Sie im Drop-down-Menü „Set“ das zu kontrollierende Audiokanalpaar aus

Anschließen an ein Netzwerk

Wenn Sie einen SmartView oder SmartScope Monitor in ein Netzwerk einbinden, können Sie Monitoreinstellungen für mehrere Einheiten aus der Ferne ändern.

SmartView und SmartScope Monitore zeigen Video ohne vorherige Konfiguration an. Netzwerkeinstellungen müssen hingegen vor dem Einsatz vorgegeben werden. Die Netzwerkconfiguration ist ausschließlich über eine direkte USB-Verbindung zum Computer möglich.

Direkte Ethernet-Verbindung

Über eine direkte Ethernet-Verbindung zu Ihrem Computer können Sie die Monitorkonfiguration aus der Ferne vornehmen. Hierfür ist kein Netzwerk-Switch erforderlich. Das ist praktisch, wenn die Installation und der Aufbau schnell gehen müssen. Zusätzliche Einheiten können über den aktiven Ethernet-Durchschleifausgang einer jeden Einheit in Reihe geschaltet werden. Dabei muss jede Einheit selbstständig mit Strom versorgt werden.

Wenn Sie mehrere Einheiten in Reihe schalten möchten, ohne IP-Adressen Ihres vorhandenen Studionetzwerks zu verwenden, oder wenn kein Netzwerk verfügbar ist, koppeln Sie die Einheiten einfach direkt an den Ethernet-Port Ihres Computers. Die Reihenschaltung von SmartView und SmartScope Einheiten per Ethernet geht blitzschnell, weil keine Kabel zum Netzwerk-Switch verlegt werden müssen.

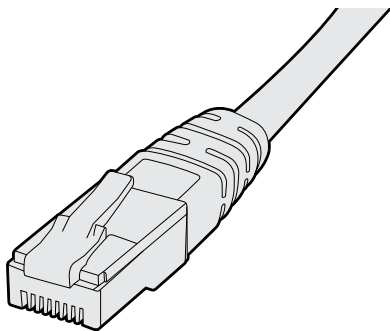

Ethernet-Stecker

Ethernet-Netzwerk-Switch

Um mehrere Einheiten in Ihr Studionetzwerk einzubinden, brauchen Sie lediglich einen SmartView oder SmartScope mit dem Netzwerk-Switch zu verbinden. Die übrigen Einheiten lassen sich über den aktiven Ethernet-Durchschleifausgang eines jeden Geräts in Reihe schalten. Es wird also nur ein einziger Port an Ihrem Netzwerk-Switch belegt. Das erspart Ihnen das Verlegen unzähliger Kabel zum Netzwerk-Switch. Bei einer Reihenschaltung muss jede Einheit selbstständig mit Strom versorgt werden.

Durch die Verbindung zu einem Netzwerk-Switch lassen sich die Einstellungen einer Einheit von jedem beliebigen Computer aus ändern. Sofern Ihr Netzwerk über einen Wireless Access Point verfügt, lassen sich mit einem Mac- oder Windows-Laptop Änderungen zudem über eine WLAN-Verbindung vornehmen.

Um einen SmartView oder SmartScope in ein lokales IP-Netzwerk einzubinden, führen Sie folgende Schritte aus.

- 1 Versorgen Sie Ihr Gerät über das mitgelieferte Netzteil mit Strom und schalten Sie es ein.
- 2 Schließen Sie die Einheit an einen Netzwerk-Switch oder über ein normgerechtes RJ45-Ethernet-Kabel direkt an einen Computer an.

Anschlussdiagramm für direkte Ethernet-Verbindungen

Sie können den Ethernet-Port eines Computers ohne Umwege über einen Netzwerk-Switch direkt mit Ihrer Einheit verbinden. Weitere Einheiten lassen sich dann miteinander verbinden. Das erspart Ihnen das Verlegen mehrerer Kabel zum Netzwerk-Switch. Jede Einheit muss selbstständig mit Strom versorgt werden.

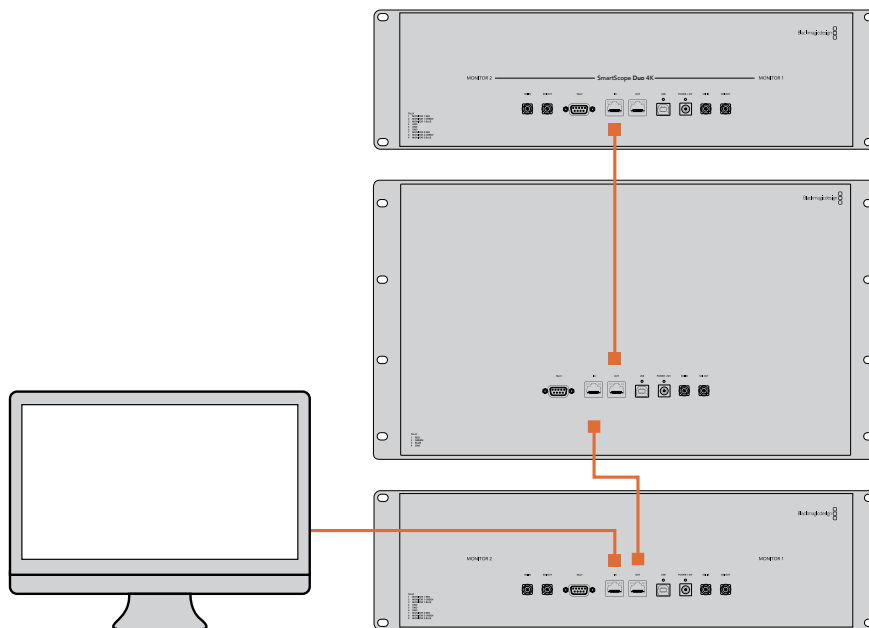

Sollte kein DHCP-Server vorhanden sein, haben Sie die Möglichkeit, die Funktion „Internetfreigabe“ auf macOS bzw. die Funktion „Internetverbindungsfreigabe“ (ICS) auf Windows 8.1 oder Windows 10 zu aktivieren. Darüber werden DHCP-Adressen an alle direkt verbundenen Einheiten zugewiesen. Die manuelle Zuweisung statischer IP-Adressen an einzelne Einheiten erübrigt sich damit. Sie können die Funktion auch dann nutzen, wenn Ihr Computer über keine Internetverbindung verfügt. Details zur Internetfreigabe finden Sie in der Hilfedokumentation zu macOS bzw. Windows 8.1 und 10.

Kann DHCP zur Konfiguration nicht verwendet werden, wählen Sie die Option „Static IP“. Fragen Sie Ihren Systemadministrator nach einer freien IP-Adresse. Dadurch verhindern Sie IP-Konflikte in Ihrem Netzwerk. Jede SmartView und SmartScope Einheit muss eine individuelle IP-Adresse sowie eine gemeinsame Subnetzmaske zugewiesen werden. Der Standardwert im „Gateway“-Feld kann beibehalten werden, es sei denn Sie möchten Ihre Einheiten an ein Netzwerk-Gateway wie einen Internet-Router anschließen.

Werden keine SmartView oder SmartScope Monitore im Netzwerk gefunden, wurden den Einheiten ggf. keine IP-Adressen via DHCP zugewiesen. In diesem Fall ist es notwendig, die Netzwerkeinstellungen einer jeden Einheit manuell zu konfigurieren.

- 1 Verbinden Sie einen Blackmagic SmartView oder SmartScope Monitor per USB mit Ihrem Computer und starten Sie Blackmagic SmartView Setup.
- 2 Der angeschlossene Monitor wird automatisch auf der Blackmagic SmartView Setup Homepage angezeigt. Neben seinem Namen erscheint ein USB-Icon.
- 3 Passen Sie die Netzwerkeinstellungen des Monitors an.
- 4 Wiederholen Sie diese Schritte für alle weiteren Einheiten, denen keine IP-Adresse via DHCP zugewiesen wurde.

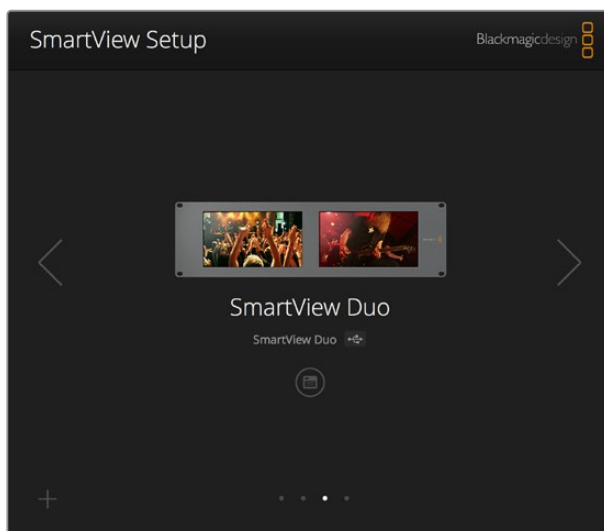

Das USB-Icon neben dem Monitornamen deutet darauf hin, dass der Monitor per USB mit Ihrem Computer verbunden ist. Eine USB-Verbindung muss hergestellt werden, damit die Netzwerkeinstellungen Ihres Blackmagic Monitors angepasst werden können

Monitor Configure	
Details	
Name:	SmartView Duo
Software Version:	4.0.1
Network Settings	
IP setting:	<input type="radio"/> DHCP <input checked="" type="radio"/> Static IP
IP Address:	192.168.10.42 ✓
Subnet Mask:	255.255.255.0
Gateway:	192.168.10.1
<input type="button" value="Cancel"/> <input type="button" value="Save"/>	

Für Netzwerkeinstellungen stehen die Optionen „DHCP“ oder „Static IP“ zur Verfügung und können ausschließlich via USB geändert werden

Hinzufügen eines Blackmagic Monitors

Wenn Sie die IP-Adresse eines SmartView oder SmartScope Duo 4K bereits kennen und diese nicht automatisch auf der Blackmagic SmartView Setup Homepage erscheint, können Sie den Monitor manuell hinzufügen. Das geht so:

- 1 Vergewissern Sie sich, dass Ihr Blackmagic Monitor per Ethernet verbunden ist. Um das Fenster „Add a Blackmagic Monitor“ zu öffnen, klicken Sie in der linken unteren Ecke auf das +-Icon.
- 2 Geben Sie die IP-Adresse des Monitors ein und klicken Sie auf „Add“.
- 3 Die Software verifiziert die Einheit nun und fügt sie zu den übrigen Blackmagic Monitoren auf der Blackmagic SmartView Setup Homepage hinzu. Klicken Sie auf den Rechtspfeil, um den neu hinzugefügten Monitor anzuzeigen.

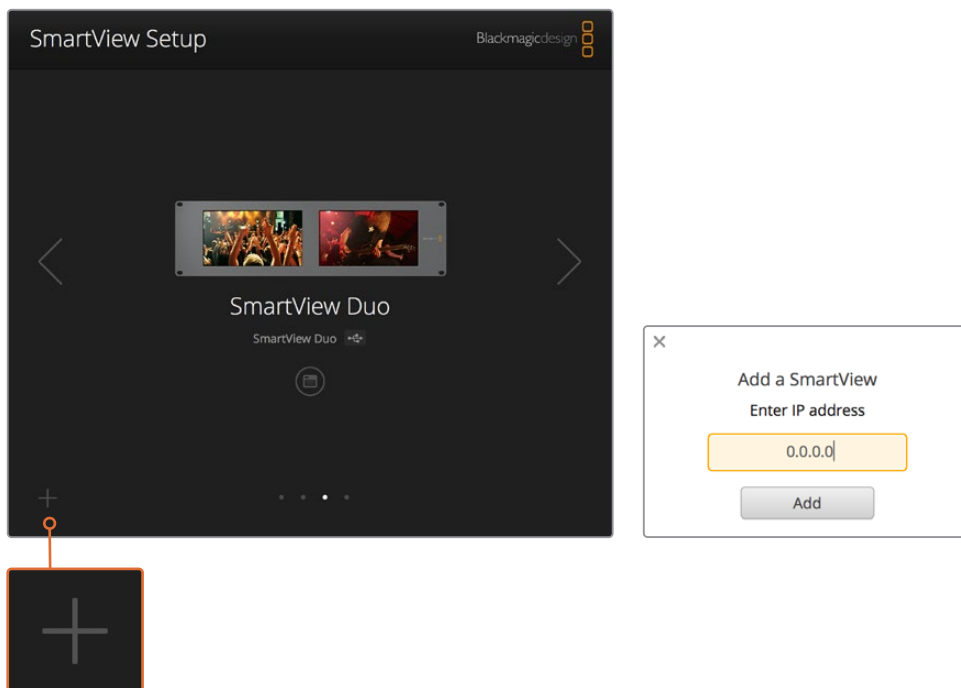

SmartView oder SmartScope Monitore können per Klick auf das +-Icon und Eingabe der Monitor-IP-Adresse manuell zur Liste der verbundenen Monitore hinzugefügt werden

Arbeiten mit Tally

Pinbelegung des Tally-Ports

Die Verwendung des Tally-Ports am SmartView oder SmartScope bleibt allein Ihnen überlassen. Überspringen Sie dieses Kapitel, wenn Sie die Tally-Funktion nicht nutzen wollen.

SmartView und SmartScope Monitore verfügen über verschiedenfarbige Tally-Umrandungen in den Farben Rot, Grün und Blau. Diese zeigen den Status eines Videosignals an, bspw. on air, Vorschau oder Aufzeichnung.

Der 9-polige D-Sub-Port empfängt Signale von Mischern und Automationssystemen. Informationen zur Verdrahtung des Tally-Ports für den Einsatz mit Ihrem Mischer oder Automationssystem finden Sie im beigefügten Anschlussdiagramm.

Eine Beschreibung zur Verdrahtung des 9-poligen D-Sub-Ports ist zudem auf jeder Einheit abgedruckt und zeigt die Pinbelegung für rote, grüne und blaue Tally-Umrandungen für jeden Monitor an.

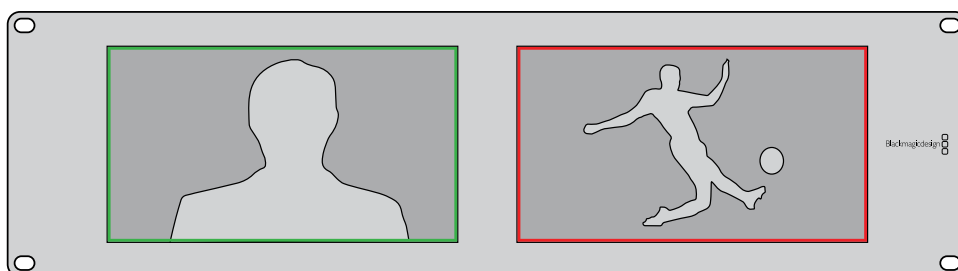

SmartView Duo mit grüner und roter Tally-Umrandung

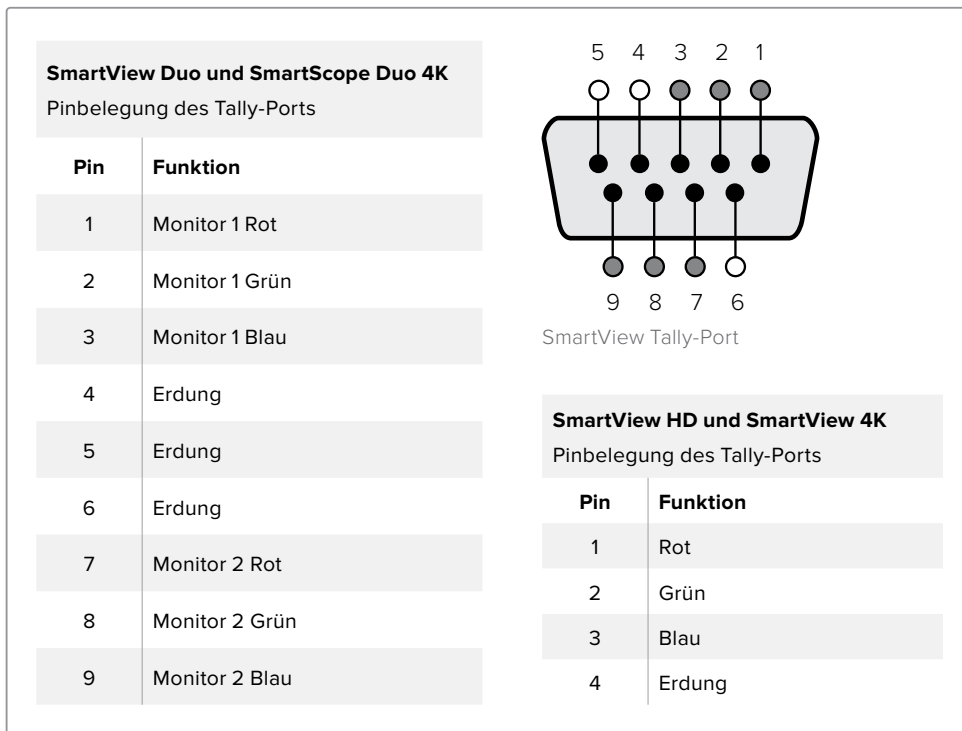

Optimieren des Betrachtungswinkels

Wenn SmartView Duo, SmartView HD oder SmartScope Monitore weit oben in einem Rack installiert werden, möchten Sie die LCDs ggf. physikalisch invertieren, um den Betrachtungswinkel zu optimieren. Wird eine Invertierung erkannt, richtet sich das LCD-Bild automatisch korrekt aus. Ein Pozidriv-Schraubendreher der Größe 02 wird benötigt, um die Blende vom Gerät zu lösen. Dieser Vorgang ist einfach, da die Rückseite des Gehäuses nicht geöffnet wird.

Im Folgenden wird beschrieben, wie das Gerät invertiert wird, während die korrekte Ausrichtung des Blackmagic Design Logos und der Blende beibehalten werden. Wie bereits erwähnt wird hierfür ein Pozidriv-Schraubendreher benötigt.

- 1 Entfernen Sie die oberen, unteren, linken und rechten Schrauben der Blende. Der SmartView Duo und der SmartScope Duo 4K haben 10, der SmartView HD hat 18 Schrauben.
- 2 Entfernen Sie die Blende wie abgebildet von der Rückseite des Gehäuses.
- 3 Invertieren Sie die Rückseite des Gehäuses.
- 4 Setzen Sie die Blende auf die invertierte Rückseite des Gehäuses auf.
- 5 Setzen Sie die Schrauben wieder ein und ziehen Sie sie fest.

Ihr SmartView oder SmartScope ist nun bereit zur Montage weit oben im Rack. Ist der SmartView mit dem Rack verschraubt, bleibt auch dann der optimale Betrachtungswinkel erhalten, wenn der Monitor Stöße abbekommt, da er keine externen Regler oder Knöpfe hat, die sich lösen könnten.



Bevor Sie den Monitor mit dem Rack verschrauben, ist es empfehlenswert, den optimalen Betrachtungswinkel zu überprüfen

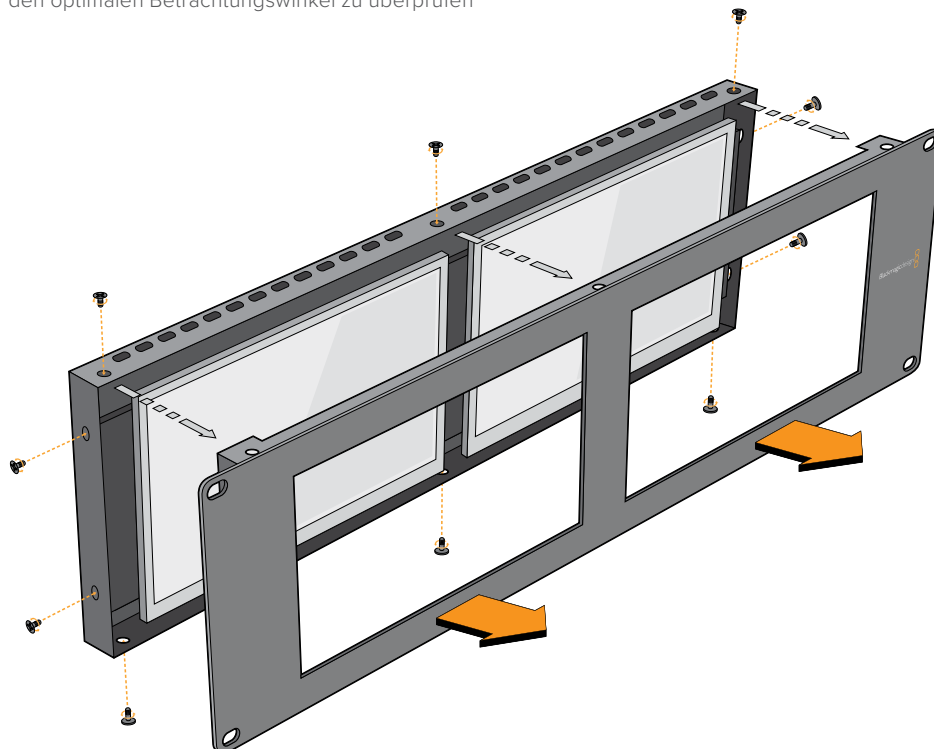

Entfernen Sie alle Schrauben, damit Sie die Blende vom hinteren Teil des Geräts abheben können

Informationen für Entwickler (Englisch)

Developing Custom Software Using Blackmagic Design Hardware

The Blackmagic SmartView Ethernet Protocol allows developers to remotely control Blackmagic SmartView and SmartScope hardware with their own custom software. The Blackmagic SmartView Ethernet Protocol is a text-based status and control protocol.

Downloading the Free SmartView Ethernet Protocol

The Blackmagic SmartView Ethernet Protocol is free. It is included in this SmartView & SmartScope manual and can be downloaded from <http://www.blackmagicdesign.com/de/support>

Joining the Blackmagic Design Developer List

The Blackmagic Developer mailing list is designed for technical questions regarding technologies used by Blackmagic Design, e.g., QuickTime, Core Media, DirectShow, codecs, APIs, SDKs, etc. The free mailing list is a forum where developers can discuss ideas and problems with other developers. Any subscriber may reply and the Blackmagic Design engineers may also respond when appropriate. You can subscribe to the mailing list at: <http://lists.blackmagicdesign.com/mailman/listinfo/bmd-developer>

In some cases, we might request a brief outline of the software you are developing if it is not immediately obvious from your domain name that your organization develops video software. Please don't take offence as we're simply trying to keep the list free of spam and viruses as well as end-user customers asking non-development questions, employment agents or sales people trying to promote products on the list. The list is just for developers.

Contacting Blackmagic Design Developer Assistance

You can also contact us via developer@blackmagicdesign.com if you have any developer related questions or wish to ask questions off the list.



Blackmagic 2K Format – Overview

Blackmagic Design products support 3G-SDI video, which allows twice the data rate of traditional HD-SDI video. We thought it would be a really nice idea to add 2K film support, via 3G-SDI technology, so we could simplify feature film workflows. With the popularity of Blackmagic Design editing systems worldwide, now thousands of people can benefit from a feature film workflow revolution.

This information includes everything product developers need to know for building native 2K SDI equipment. Of course, all Blackmagic products can be updated, so if the television industry adopts an alternative SDI-based film standard, we can add support for that too!

Frame Structure

- Transmitted at 23.98, 24 or 25 frames per second as a Progressive Segmented Frame.
- Active video is 2048 pixels wide by 1556 lines deep.
- Total lines per frame : 1650
- Active words per line are 1535. One word consists of a 10-bit sample for each of the four data streams, i.e., a total of 40 bits. See the diagram named Blackmagic 2K Format - Data Stream Format.
- Total active lines : 1556
- Total words per line : 1875 for 23.98/24Hz and 1800 for 25Hz.
- Fields per frame : 2, 825 lines each
- Active lines located on lines 16-793 (field 1) and 841-1618 (field 2).

Transport Structure

- Based on SMPTE 372M Dual Link mapping and SMPTE 425M-B support for mapping SMPTE 372M into a single 3 Gb/s link.
- Timing reference signals, line number and line CRC insertion is the same as above.
- During active video, 10-bit Red, Green and Blue data is sent in the following sequence:
- Optional ancillary data is inserted into both virtual interfaces.
- At present, only audio data is included: as per standard HD audio insertion (SMPTE S299M) the audio data packets are carried on data stream two and audio control packets are carried on data stream one.
 - Data stream 1: Green_1, Green_2, Green_3, Green_5...Green_2047
 - Data stream 2: Blue_1, Blue_2, Green_4, Blue_5...Green_2048.
 - Data stream 3: Red_1, Blue_3, Blue_4, Red_5...Blue_2048.
 - Data stream 4: Red_2, Red_3, Red_4, Red_6...Red_2048.

Blackmagic 2K Format – Vertical Timing Reference

This diagram shows the vertical timing details with line numbers and Field, Vertical and Horizontal bits for the Timing Reference Signal codes.

		Field 1					Active					
F	1	0	0	0	0	0	0	0	0	0	0	0
V	1	1	1	1	1	1	0	0	0	0	1	1
LINE #	1650	1	2	...	14	15	16	...	792	793	...	825

		Field 2					Active					
F	0	1	1	1	1	1	1	1	1	1	1	1
V	1	1	1	1	1	1	0	0	0	0	1	1
LINE #	825	826	827	...	839	840	841	...	1617	1618	...	1650

Blackmagic 2K Format – Data Stream Format

This diagram shows the data stream formats around the optional ancillary data section of the horizontal line. Note that each active pixel takes up three samples.

Word# 25 PsF	Word# 23.98/24 PsF	Data Stream 4	Data Stream 3	Data Stream 2	Data Stream 1
1795	1870	R2042	R2041	B2041	G2041
1796	1871	R2043	B2043	B2042	G2042
1797	1872	R2044	B2044	G2044	G2043
1798	1873	R2046	R2045	B2045	G2045
1799	1874	R2047	B2047	B2046	G2046
1800	1875	R2048	B2048	G2048	G2047
1	1	EAV(3FFh)	EAV(3FFh)	EAV(3FFh)	EAV(3FFh)
2	2	EAV(000h)	EAV(000h)	EAV(000h)	EAV(000h)
3	3	EAV(000h)	EAV(000h)	EAV(000h)	EAV(000h)
4	4	EAV(XYZh)	EAV(XYZh)	EAV(XYZh)	EAV(XYZh)
5	5	LN0	LN0	LN0	LN0
6	6	LN1	LN1	LN1	LN1
7	7	CRC0	CRC0	CRC0	CRC0
8	8	CRC1	CRC1	CRC1	CRC1
9	9	200	040	ANC/Audio Data	ANC/Audio Data
...		
260	335	200	040		
261	336	SAV(3FFh)	SAV(3FFh)	SAV(3FFh)	SAV(3FFh)
262	337	SAV(000h)	SAV(000h)	SAV(000h)	SAV(000h)
263	338	SAV(000h)	SAV(000h)	SAV(000h)	SAV(000h)
264	339	SAV(XYZh)	SAV(XYZh)	SAV(XYZh)	SAV(XYZh)
265	340	R2	R1	B1	G1
266	341	R3	B3	B2	G2
267	342	R4	B4	G4	G3
268	343	R6	R5	B5	G5

Blackmagic SmartView Ethernet Protocol v1.3

Summary

The Blackmagic SmartView Ethernet Protocol is a text-based status and control protocol, very similar in structure to the Videohub protocol, that is accessed by connecting to TCP port 9992 on a SmartView or SmartScope device.

Upon connection, the SmartView or SmartScope device sends a complete dump of the state of the device. After the initial dump, state changes are sent asynchronously.

The device sends information in blocks which have an identifying header, followed by a colon. A block can span multiple lines and is terminated by a blank line.

To be resilient to future protocol changes, clients should ignore blocks they do not recognize, up to the trailing blank line. Within recognized blocks, clients should ignore lines they do not recognize.

Legend

↵ carriage return
... and so on

Version 1.3 of the Blackmagic SmartView Ethernet Protocol was released with SmartView 1.3 software.

Protocol Preamble

The first block sent by the SmartView Server is always the protocol preamble:

```
PROTOCOL PREAMBLE:↵  
Version: 1.3 ↵  
↵
```

The version field indicates the protocol version. When the protocol is changed in a compatible way, the minor version number will be updated. If incompatible changes are made, the major version number will be updated.

Device Information

The next block contains general information about the connected SmartView or SmartScope device.

```
SMARTVIEW DEVICE:↵  
Model: SmartView Duo↵  
Hostname: stagefront.studio.example.com↵  
Name: StageFront↵  
Monitors: 2↵  
Inverted: false↵  
↵
```

This example shows the output for a SmartView Duo device, which has two LCDs.

The INVERTED flag indicates whether the device has detected that it has been mounted in an inverted configuration to optimize LCD viewing angle.

Network Configuration

The next block shows the TCP/IP networking configuration:

```
NETWORK:↵
Dynamic IP: true↵
Static address: 192.168.2.2↵
Static netmask: 255.255.255.0↵
Static gateway: 192.168.2.1↵
Current address: 192.168.1.101↵
Current netmask: 255.255.255.0↵
Current gateway: 192.168.1.1↵
↵
```

The network settings prefixed with CURRENT show the active TCP/IP settings, and are read-only. The CURRENT settings reflect either the DHCP or Static configuration, depending on the DYNAMIC IP flag.

Changing Networking Settings

The network can be configured to use either DHCP or a static configuration. To enable DHCP:

```
NETWORK:↵
Dynamic IP: true↵
↵
```

To set a fixed IP address, supply all static parameters, thus:

```
NETWORK:↵
Dynamic IP: false↵
Static address: 192.168.2.2↵
Static netmask: 255.255.255.0↵
Static gateway: 192.168.2.1↵
↵
```

The parameters with the CURRENT prefix are read-only, and show the active configuration, regardless of the static or dynamic setting.

Changing the device name, or any network settings, will cause the IP connection to be dropped. The device will restart its networking and advertise its new name on the network.

Changing Monitor Settings

The display settings for each monitor are specified individually. One or more parameters can be modified at the same time and multiple settings can be supplied in one block.

The valid range for numeric values is 0-255. The CONTRAST and SATURATION properties are zero-centered, so the normal value is 127, such that the displayed picture is the same as the original. A value greater than 127 in either channel will cause the contrast or saturation to be increased, and similarly a value less than 127 will cause a decrease.

For example, to set the brightness to 50% and desaturate the image to Black & White:

```
MONITOR A:↵
Brightness: 127↵
Saturation: 0↵
↵
```

Displaying SD in 16:9

The following command sets standard definition video to display in 16:9:

```
MONITOR A:↵  
WidescreenSD: ON↵
```

Displaying SD in 4:3

The following command sets standard definition video to display in 4:3:

```
MONITOR A:↵  
WidescreenSD: OFF↵
```

Identification and Tally Settings

The Identify flag is transient, and will cause a white border to be displayed around the entire picture for a duration of 15 seconds, after which it will be reset. This feature is primarily aimed at identifying which monitor is currently being configured when it is mounted in a rack comprising multiple units. To turn on:

```
MONITOR A:↵  
Identify: true↵  
↵
```

The IDENTIFY border will temporarily override any other border setting in effect.

The BORDER property can be used to programmatically set the soft Tally colored borders to one of the primary colors: RED, GREEN, BLUE, WHITE or NONE. This setting can be overridden by the electrical Tally signals at the DB-9 input on the device itself. For example, to set the soft Tally to green:

```
MONITOR B:↵  
Border: green↵  
↵
```

The hard wired tally will always override the soft tally. The full state report will always show the current valid border.

SmartScope Settings

On SmartScope Duo 4K, each monitor can be set to display a different scope. The values for activating specific scopes are mapped as follows:

- AudioDbfs
- AudioDbvu
- Histogram
- ParadeRGB
- ParadeYUV
- Picture (This is the same as Video Monitor)
- Vector100
- Vector75
- WaveformLuma

```
MONITOR A:↵  
ScopeMode: Picture↵  
↵
```

In the example above, Monitor A has been set as a video monitor.

Displaying SD in 16:9

To set Video Monitor mode to display standard definition video in 16:9:

```
MONITOR A:↵  
ScopeMode: Picture↵  
WidescreenSD: ON↵
```

Displaying SD in 4:3

To set Video Monitor mode to display standard definition video in 4:3:

```
MONITOR A:↵  
ScopeMode: Picture↵  
WidescreenSD: OFF↵
```

When setting one of SmartScope Duo 4K's monitors to audio metering, you can also select which channels to show. The values for selecting which audio channels are mapped in the following way:

- 0: Channels 1 and 2
- 1: Channels 3 and 4
- 2: Channels 5 and 6
- 3: Channels 7 and 8
- 4: Channels 9 and 10
- 5: Channels 11 and 12
- 6: Channels 13 and 14
- 7: Channels 15 and 16

```
MONITOR B:↵  
ScopeMode: AudioDbvu↵  
AudioChannel: 0↵  
↵
```

In the example above, Monitor B has been selected to display Audio Metering in Dbvu with audio channels 1 and 2 selected for the phase meter.

Selecting LUTs for SmartView 4K

To select 3D LUTs using SmartView 4K:

```
MONITOR A:↵  
LUT: 0    LUT 1  
    1    LUT 2  
    NONE  DISABLE  
↵  
↵
```

Hilfe

Hilfestellung

Es gibt vier Möglichkeiten, sich Hilfe zu holen.

- 1** Holen Sie sich die neuesten Informationen im Blackmagic Design Support-Center unter www.blackmagicdesign.com/de/support.
- 2** Rufen Sie Ihren Blackmagic Design Händler an.
- 3** Ihr lokaler Händler verfügt über die aktuellsten Informationen von Blackmagic Design und sollte in der Lage sein, Ihnen sofort behilflich zu sein. Darüber hinaus empfehlen wir Ihnen, sich über die Support-Optionen Ihres Händlers zu informieren, da dieser Ihnen entsprechend Ihrer Workflow-Anforderungen unter die Arme greifen kann.
- 4** Oder kontaktieren Sie uns mit Ihren Fragen per E-Mail, indem Sie unter www.blackmagicdesign.com/de/support auf „Senden Sie uns eine E-Mail“ klicken.
- 5** Rufen Sie eine Blackmagic Design Support-Stelle an. Klicken Sie hierfür unten auf der Support-Seite auf „Finden Sie Ihr lokales Support-Team“.

Bitte stellen Sie uns so viele Informationen und Systemspezifikationen zur Verfügung wie Sie können, damit wir schnellstmöglich auf Ihr technisches Problem eingehen können.

Gesetzliche Vorschriften

Entsorgung von elektrischen und elektronischen Geräten innerhalb der Europäischen Union



Das auf dem Produkt abgebildete Symbol weist darauf hin, dass dieses Gerät nicht zusammen mit anderen Abfallstoffen entsorgt werden darf. Altgeräte müssen daher zur Wiederverwertung an eine dafür vorgesehene Sammelstelle übergeben werden. Mülltrennung und Wiederverwertung von Altgeräten tragen zum nachhaltigen Umgang mit natürlichen Ressourcen bei. Gleichzeitig wird sichergestellt, dass die Wiederverwertung nicht zulasten der menschlichen Gesundheit und der Umwelt geht. Weitere Informationen zur Entsorgung von Altgeräten sowie zu den Standorten der zuständigen Sammelstellen erhalten Sie von Ihren örtlichen Müllentsorgungsbetrieben sowie vom Händler, bei dem Sie dieses Produkt erworben haben.



Dieses Gerät wurde geprüft und entspricht den Grenzwerten für Digitalgeräte der Klasse A gemäß Abschnitt 15 der FCC-Bestimmungen für Funkentstörung. Diese Grenzwerte dienen dem angemessenen Schutz vor schädlichen Störungen bei Betrieb des Geräts in einer kommerziellen Einrichtung. Geräte dieser Art erzeugen und verwenden Hochfrequenzen und können diese auch ausstrahlen. Bei Nichteinhaltung der Installations- und Gebrauchsvorschriften können sie zu Störungen beim Rundfunkempfang führen. Der Betrieb solcher Geräte in Wohngebieten führt mit großer Wahrscheinlichkeit zu Funkstörungen. In diesem Fall kann vom Betreiber verlangt werden, selbst für die Beseitigung solcher Störungen aufzukommen.

Der Betrieb unterliegt den folgenden zwei Bedingungen:

- 1 Das Gerät darf keine schädigenden Störungen hervorrufen.
- 2 Das Gerät muss unanfällig gegenüber beliebigen empfangenen Störungen sein, einschließlich solcher, die einen unerwünschten Betrieb verursachen.



MSIP-REM-BMD-201410001
MSIP-REM-BMD-20150327
MSIP-REM-BMD-201702004
MSIP-REM-BMD-201702005

ISED-Zertifizierung für den kanadischen Markt

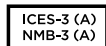

Dieses Gerät erfüllt die kanadischen Vorschriften für digitale Geräte der Klasse A.

Jedwede an diesem Produkt vorgenommene Änderung oder unsachgemäße Verwendung kann die Konformitätserklärung zum Erlöschen bringen.

Verbindungen zu HDMI-Schnittstellen müssen über hochwertige abgeschirmte HDMI-Kabel hergestellt werden.

Die Ausstattung wurde unter Einhaltung der beabsichtigten Nutzung in einer gewerblichen Umgebung getestet. Bei Einsatz des Geräts in einer häuslichen Umgebung verursacht es möglicherweise Funkstörungen.

Sicherheitshinweise

Zum Schutz vor Stromschlag muss das Gerät an ein vorschriftsmäßig geerdetes Stromnetz angeschlossen werden. Kontaktieren Sie im Zweifelsfall eine Elektrofachkraft.

Um das Risiko eines Stromschlages zu verringern, setzen Sie das Gerät weder Tropfen noch Spritzern aus.

Das Produkt eignet sich für den Einsatz in tropischen Gebieten mit einer Umgebungstemperatur von bis zu 40 °C.

Sorgen Sie rund um das Gerät für eine angemessene und unbehinderte Luftzufuhr.

Achten Sie bei der Installation im Rack darauf, dass die Luftzufuhr nicht durch andere Geräte eingeschränkt wird.

Im Inneren des Produkts befinden sich keine durch den Anwender zu wartenden Teile. Wenden Sie sich für die Wartung an ein Blackmagic Design Service Center in Ihrer Nähe.

Einige Produkte verfügen über einen Steckplatz für einen kleinen SFP-Tranceiver (Small Form Pluggable Sende-/Empfangsgerät) für ein Glasfasermodul. Es dürfen nur SFP-Glasfasermodule der Laserklasse 1 eingesetzt werden.

Blackmagic Design empfiehlt die nachstehenden SFP-Module:

- **3G-SDI:** PL-4F20-311C
- **6G-SDI:** PL-8F10-311C
- **12G-SDI:** PL-TG10-311C



Nur in Höhen bis 2000 m über dem Meeresspiegel einsetzen.

California Proposition 65

Plastikteile dieses Produkts können Spuren von polybromierten Biphenylen enthalten. Im US-amerikanischen Bundesstaat Kalifornien werden diese Chemikalien mit Krebs, Geburtsfehlern und anderen Schäden der Fortpflanzungsfähigkeit in Verbindung gebracht.

Weitere Informationen finden Sie unter www.P65Warnings.ca.gov.

Garantie

12 Monate eingeschränkte Garantie

Für dieses Produkt gewährt die Firma Blackmagic Design eine Garantie auf Material- und Verarbeitungsfehler von 12 Monaten ab Kaufdatum. Sollte sich ein Produkt innerhalb dieser Garantiezeit als fehlerhaft erweisen, wird die Firma Blackmagic Design nach ihrem Ermessen das defekte Produkt entweder ohne Kostenerhebung für Teile und Arbeitszeit reparieren oder Ihnen das defekte Produkt ersetzen.

Zur Inanspruchnahme der Garantieleistungen müssen Sie als Kunde Blackmagic Design über den Defekt innerhalb der Garantiezeit in Kenntnis setzen und die entsprechenden Vorkehrungen für die Leistungserbringung treffen. Es obliegt dem Kunden, für die Verpackung und den bezahlten Versand des defekten Produkts an ein spezielles von Blackmagic Design benanntes Service Center zu sorgen und hierfür aufzukommen. Sämtliche Versandkosten, Versicherungen, Zölle, Steuern und sonstige Abgaben im Zusammenhang mit der Rücksendung von Waren an uns, ungeachtet des Grundes, sind vom Kunden zu tragen.

Diese Garantie gilt nicht für Mängel, Fehler oder Schäden, die durch unsachgemäße Handhabung oder unsachgemäße oder unzureichende Wartung und Pflege verursacht wurden. Blackmagic Design ist im Rahmen dieser Garantie nicht verpflichtet, die folgenden Serviceleistungen zu erbringen: a) Behebung von Schäden infolge von Versuchen Dritter, die Installation, Reparatur oder Wartung des Produkts vorzunehmen, b) Behebung von Schäden aufgrund von unsachgemäßer Handhabung oder Anschluss an nicht kompatible Geräte, c) Behebung von Schäden oder Störungen, die durch die Verwendung von nicht Blackmagic-Design-Ersatzteilen oder -Verbrauchsmaterialien entstanden sind, d) Service für ein Produkt, das verändert oder in andere Produkte integriert wurde, sofern eine solche Änderung oder Integration zu einer Erhöhung des Zeitaufwands oder zu Schwierigkeiten bei der Wartung des Produkts führt. ÜBER DIE IN DIESER GARANTIEERKLÄRUNG AUSDRÜCKLICH AUFGEFÜHRTEN ANSPRÜCHE HINAUS ÜBERNIMMT BLACKMAGIC DESIGN KEINE WEITEREN GARANTIEN, WEDER AUSDRÜCKLICH NOCH STILLSCHWEIGEND. DIE FIRMA BLACKMAGIC DESIGN UND IHRE HÄNDLER LEHNEN JEGLICHE STILLSCHWEIGENDEN GARANTIEN IN BEZUG AUF AUSSAGEN ZUR MARKTGÄNGIGKEIT UND GEBRAUCHSTAUGLICHKEIT FÜR EINEN BESTIMMTEN ZWECK AB. DIE VERANTWORTUNG VON BLACKMAGIC DESIGN, FEHLERHAFTEN PRODUKTE ZU REPARIEREN ODER ZU ERSETZEN, IST DIE EINZIGE UND AUSSCHLIESSLICHE ABHILFE, DIE GEGENÜBER DEM KUNDEN FÜR ALLE INDIREKTEN, SPEZIELLEN, NEBEN- ODER FOLGESCHÄDEN ZUR VERFÜGUNG GESTELLT WIRD, UNABHÄNGIG DAVON, OB BLACKMAGIC DESIGN ODER DER HÄNDLER VON DER MÖGLICHKEIT SOLCHER SCHÄDEN ZUVOR IN KENNTNIS GESETZT WURDE. BLACKMAGIC DESIGN IST NICHT HAFTBAR FÜR JEGLICHE WIDERRECHTLICHE VERWENDUNG DER GERÄTE DURCH DEN KUNDEN. BLACKMAGIC HAFTET NICHT FÜR SCHÄDEN, DIE SICH AUS DER VERWENDUNG DES PRODUKTS ERGEBEN. NUTZUNG DES PRODUKTS AUF EIGENE GEFAHR.

© Copyright 2020 Blackmagic Design. Alle Rechte vorbehalten. „Blackmagic Design“, „DeckLink“, „HDLink“, „Workgroup Videohub“, „Multibrige Pro“, „Multibrige Extreme“, „Intensity“ und „Leading the creative video revolution“ sind eingetragene Warenzeichen in den USA und in anderen Ländern. Alle anderen Unternehmens- und Produktnamen sind möglicherweise Warenzeichen der jeweiligen Firmen, mit denen sie verbunden sind.



Manual de instalación y funcionamiento

SmartView y SmartScope

Septiembre 2020

Español



Bienvenido

Ojalá compartas nuestro sueño de transformar la industria televisiva en un sector verdaderamente creativo, donde todos tengan acceso a la mejor calidad en materia de imagen.

La supervisión de señales audiovisuales es fundamental en todo tipo de instalaciones. El monitor SmartView 4K presenta un diseño elegante de 6 U con una pantalla LCD para monitorizar imágenes UHD y un panel de control que permite modificar ajustes con rapidez. La versión SmartView HD incluye una pantalla LCD de 17 pulgadas en un tamaño de 6 U y menos de 4 centímetros de espesor. Por su parte, el modelo SmartView Duo cuenta con dos pantallas LCD de 8 pulgadas completamente independientes en un tamaño de 3 U y menos de 4 centímetros de espesor, mientras que la versión SmartScope Duo 4K ofrece las mismas características y ofrece instrumentos de medición para ajustar los diversos aspectos de la señal sobre la marcha. Todos los monitores SmartView brindan conectividad SDI 3G y admiten imágenes en definición SD, HD y 2K. A su vez, cabe destacar que los modelos SmartScope Duo 4K y SmartView 4K incluyen conexiones SDI 6G y 12G, respectivamente, que facilitan la monitorización de material UHD 4K.

Los dispositivos están diseñados para funcionar de forma inmediata una vez adquiridos, y al mismo tiempo nuestro programa utilitario gratuito ofrece al usuario una herramienta de configuración fácil e intuitiva.

El manual de instrucciones contiene toda la información necesaria para instalar el producto, aunque recomendamos consultar a un técnico si no estás seguro de lo que es una dirección IP o no tienes demasiados conocimientos sobre redes informáticas. A pesar de que la instalación de los distintos modelos SmartView y SmartScope es sencilla, quizás sea necesario modificar algunos ajustes una vez finalizado este procedimiento.

Estimamos que puede completarse en aproximadamente 5 minutos. En nuestra página de soporte técnico encontrarás la versión más reciente de este manual y del software para la línea de monitores SmartView. Por último, no olvides registrarte al descargar las actualizaciones, a fin de que podamos mantenerte informado sobre nuevos lanzamientos. Trabajamos constantemente para desarrollar herramientas innovadoras y superarnos, de modo que nos encantaría conocer tu opinión.

Grant Petty

Director ejecutivo de Blackmagic Design

Índice

SmartView y SmartScope

Primeros pasos	165
SmartView y SmartScope	165
Conexión de fuentes	166
Conexión de equipos informáticos	166
Instalación del programa SmartView Setup	167
Uso del programa SmartView Setup	168
Actualizaciones	168
Ajustes del monitor	168
Activar bordes indicadores	171
SmartView 4K	171
Introducción	171
Botones del panel de control	172
Aplicar LUT 3D con SmartView Setup	174
SmartScope Duo 4K	175
¿Qué es Blackmagic SmartScope?	175
Imágenes	176
Forma de onda	177
Vectorscopio	178
Luminancia y crominancia	179
Histograma	181
Medición del audio	182
Conexión a redes	183
Conexión Ethernet directa	183
Conmutador de red	184
Ajustes de red	185
Configuración de la red	185
Agregar monitores a la red	187
Sistemas de señalización	188
Conexión	188
Mejora del ángulo de visión	189
Información para desarrolladores	191
Formato 2K de Blackmagic – Información general	191
Formato 2K de Blackmagic – Referencia de temporización vertical	192
Formato 2K de Blackmagic – Transmisión de datos	193
Protocolo de Ethernet Blackmagic SmartView v1.3	194
Ayuda	198
Normativas	199
Seguridad	200
Garantía	201

Primeros pasos

SmartView y SmartScope

Los monitores SmartView son ideales para instalaciones donde es necesario supervisar señales audiovisuales mediante equipos en bastidores. Para comenzar a usarlos, solo es necesario enchufarlos a una toma de corriente y conectar una fuente SDI.

El modelo SmartView 4K cuenta con una pantalla LCD de 15.6 pulgadas que permite supervisar imágenes SD, HD o UHD en su resolución original. Los botones del panel frontal permiten seleccionar distintas entradas con facilidad, ajustar el brillo de la pantalla, comprobar el ruido en el canal azul, ver la información contenida en el intervalo de supresión y aplicar tablas de conversión, entre otras funciones.

El modelo SmartView HD dispone de una pantalla LCD de 17 pulgadas que resulta ideal para monitorizar contenidos con absoluta confianza.

Por su parte, la versión SmartView Duo incluye dos monitores para ver dos señales diferentes. A modo de ejemplo, una pantalla puede mostrar imágenes YUV 4:2:2, y la otra en contenidos formato RGB 4:4:4. De esta forma, es posible ver señales NTSC y PAL simultáneamente. Basta con conectar solo un cable SDI a cada monitor.

El modelo SmartScope Duo 4K ofrece las mismas funciones de la versión SmartView Duo y además muestra la onda de la señal, la crominancia y otras representaciones gráficas para supervisar diversos parámetros audiovisuales en tiempo real. Cabe destacar asimismo que admite imágenes UHD 4K.

Las entradas SDI de ambos dispositivos detectan automáticamente señales SD, HD o 3G, e incluso con resolución 2K. Además, el modelo SmartView 4K es compatible con formatos 2160p60, gracias a su conectividad SDI 12G. Por otro lado, la tecnología SDI 6G de la versión SmartScope Duo 4K permite detectar automáticamente señales UHD 4K.

La conexión Ethernet brinda la posibilidad de modificar los ajustes de varias unidades en forma remota desde un equipo informático, lo cual evita tener que conectarlo a cada una de ellas cuando es preciso cambiar la configuración.

Esto es todo lo que necesita saber para comenzar. Continúe leyendo para obtener más información acerca de los dispositivos y su conexión a una red Ethernet.



SmartView 4K



SmartView HD



SmartView Duo



SmartScope Duo 4K

Conexión de fuentes

Los modelos SmartView y SmartScope incluyen conectores BNC convencionales que permiten emplearlos con equipos SDI, tales como mezcladores, cámaras, grabadores y tarjetas de captura.

Visualización de imágenes

Es sumamente sencillo ver las imágenes. Basta con encender el dispositivo y conectar una fuente a una entrada SDI. A continuación, estas deberían visualizarse en forma inmediata. Tanto la entrada SDI como las conexiones derivadas detectan automáticamente señales en definición SD, HD o 2K. Cabe mencionar además que los modelos SmartView 4K y SmartScope Duo 4K son compatibles con imágenes UHD 4K.

Cuando no hay una fuente conectada al dispositivo, la unidad de retroiluminación se apagará para ahorrar energía. Esta se encenderá nuevamente al detectarse una señal compatible.

Conexión de unidades en serie

Cada modelo SmartView y SmartScope dispone de una entrada SDI independiente y una salida derivada que permite conectar varias unidades en serie.

- 1 Encienda la unidad 1. Conecte una fuente a una entrada SDI. La imagen debería verse inmediatamente.
- 2 Encienda la unidad 2. Conecte la salida derivada de la unidad 1 a una entrada SDI de la unidad 2 mediante un cable SDI.

Es posible conectar tantas unidades como sea necesario.

Al supervisar la onda de la señal mediante el modelo SmartScope Duo 4K, es aconsejable conectar el monitor 1 al monitor 2 para que ambos muestren la misma señal.

Una vez que la imagen se ve en la pantalla, es posible modificar los ajustes de los dispositivos o seleccionar una de las representaciones gráficas disponibles en el modelo SmartScope Duo 4K mediante el programa SmartView Setup. Cabe mencionar que esta aplicación también permite aplicar tablas de conversión tridimensionales en la versión SmartView 4K.



SmartView 4K



SmartView HD



SmartView Duo



SmartScope Duo 4K

Conexión de equipos informáticos

Conecte su PC al monitor mediante un cable USB 2.0 e instale el programa SmartView Setup para configurar el dispositivo.

La conexión USB permite además instalar actualizaciones para el sistema operativo interno descargadas desde nuestro sitio web. Estas ofrecen funciones adicionales, así como compatibilidad con nuevos formatos y equipos. El programa SmartView Setup puede instalarse en sistemas operativos macOS y Windows.

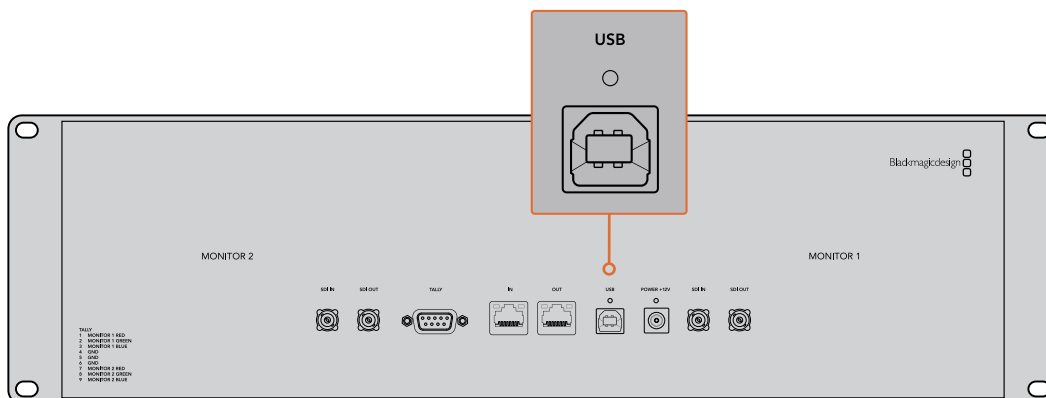

Instalación del programa SmartView Setup

Esta aplicación funciona en las últimas versiones Sierra y High Sierra del sistema operativo macOS, así como en versiones de 64 bits de Windows 8.1 y 10 con las actualizaciones más recientes instaladas. El programa también puede instalarse en varios equipos informáticos que formen parte de una red.

La tarjeta SD suministrada con el dispositivo contiene un instalador, aunque recomendamos visitar nuestro sitio web para descargar la versión más reciente.

Instalación en macOS:

Acceda al contenido de la tarjeta o de la imagen descargada y haga doble clic en el ícono de instalación. Se creará una carpeta en **Aplicaciones** con el programa, el desinstalador, que permite borrar versiones previas de la aplicación, y varios documentos que incluyen este manual y otros datos con relación al dispositivo.

Instalación en Windows:

Acceda al contenido de la tarjeta SD o del archivo comprimido descargado y haga doble clic en el instalador. Siga las instrucciones que aparecen en la pantalla para instalar el programa.

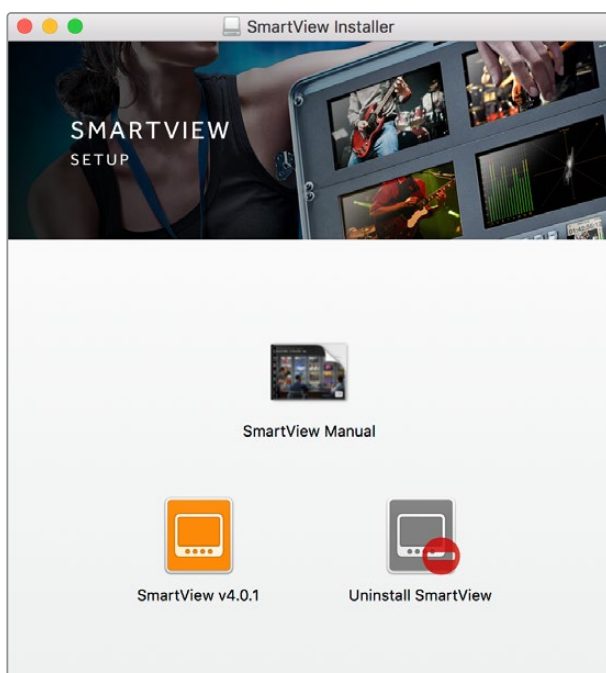

Para instalar el programa en macOS, abra el archivo SmartView.dmg descargado o incluido en la tarjeta SD que viene con el dispositivo. A continuación, haga doble clic en el ícono de instalación.

Uso del programa SmartView Setup

Actualizaciones

Ejecute el programa una vez instalado y haga clic en el ícono de configuración situado debajo del nombre del monitor. El programa le solicitará que actualice el sistema operativo interno del dispositivo si es necesario. Para ello, siga los pasos descritos a continuación.

- 1 Conecte su PC al dispositivo mediante un cable USB o a través de una red Ethernet y ejecute el programa SmartView Setup.
- 2 Cuando aparezca el mensaje indicando que es necesario actualizar el dispositivo aviso, haga clic en el botón **Update**. Este procedimiento tarda aproximadamente 5 minutos.
- 3 Al finalizar, aparecerá otro mensaje para indicar que el dispositivo se ha actualizado.
- 4 Haga clic en el botón **Close**.

Si no es necesario actualizar el dispositivo, el programa mostrará la pestaña de ajustes del monitor.

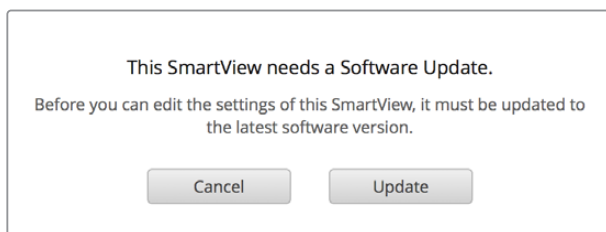

Al ejecutar el programa SmartView Setup y hacer clic en el ícono de configuración, aparecerá un mensaje si es necesario actualizar el sistema operativo interno del dispositivo.

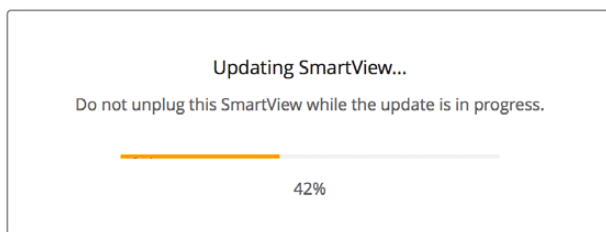

La actualización tarda aproximadamente 5 minutos.

Ajustes del monitor

Al abrir el programa, las unidades conectadas se detectan automáticamente y se muestran en la ventana de inicio. Si hay más de un monitor conectado a la red, haga clic en las flechas situadas en el margen izquierdo y derecho de la ventana para seleccionar uno de ellos. En caso de que el dispositivo esté conectado a través del puerto USB, verá el ícono correspondiente junto a su nombre.

Para cambiar las opciones, seleccione la unidad conectada y haga clic en el ícono de configuración debajo del nombre. Esto permite acceder al panel de ajustes. Una vez realizados los cambios necesarios, haga clic en el botón **Save** para guardarlos y volver a la ventana de inicio.

Consulte el apartado siguiente a fin de obtener información adicional sobre las opciones disponibles para cada modelo. Consulte el apartado “Ajustes de red” para saber más sobre la configuración de redes mediante el programa SmartView Setup.

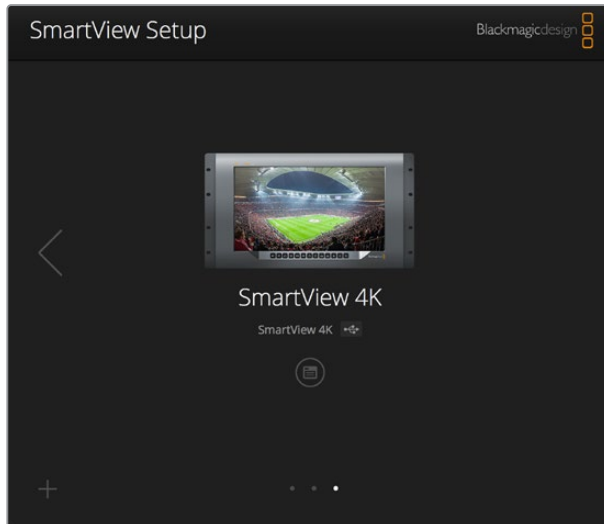

El programa busca automáticamente las unidades conectadas en forma local mediante un cable USB o a través de una red. Compruebe que el dispositivo esté conectado antes de actualizarlo. El ícono de la conexión USB aparece junto al nombre del monitor.

Ajustes del monitor

Para cambiar los ajustes del monitor, este debe estar conectado al equipo informático mediante un cable USB o una red local. Seleccione la unidad mediante las flechas situadas en el margen izquierdo y derecho de la ventana de inicio. A continuación, haga clic en el ícono de configuración debajo del nombre del dispositivo. La pestaña de ajustes mostrará las opciones disponibles para la unidad seleccionada.

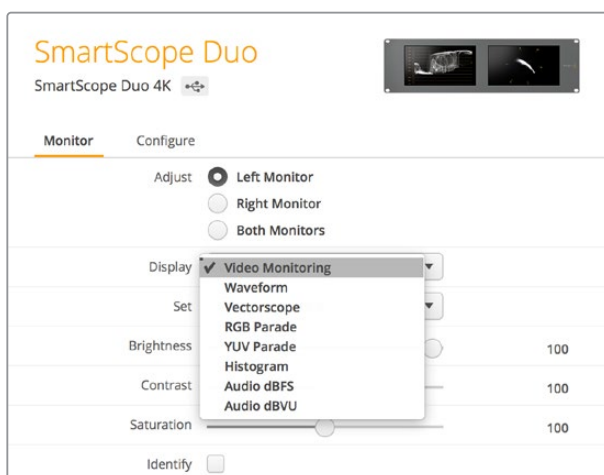

Opciones disponibles en el modelo SmartScope

Ajustar

En el caso de los modelos SmartScope y SmartView Duo, el panel **Adjust** permite seleccionar el monitor que se desea ajustar. Al escoger la opción **Both Monitors**, los cambios en el brillo, el contraste y la saturación afectarán a ambas pantallas.

Mostrar

En el caso del modelo SmartScope, el menú desplegable **Display** permite elegir la representación gráfica que se muestra en la pantalla. Para ver la señal, seleccione la opción **Video Monitoring**.

Relación de aspecto

En el caso del modelo SmartScope, el menú desplegable **Set** permite determinar la relación de aspecto para las imágenes en definición estándar. Asimismo, existen otros ajustes adicionales según la opción elegida en el menú desplegable **Display**.

- **Monitorización:** Al seleccionar la opción **Video Monitoring**, es posible escoger una relación de aspecto de 4:3 o 16:9 para las imágenes que se muestran en la pantalla. La opción 16:9 resulta adecuada para ver imágenes anamórficas en definición estándar con formato de pantalla ancha. Por el contrario, elija la opción 4:3 para el formato habitual en televisión.
- **Vectorscopio:** Al seleccionar la opción **Vectorscope**, es posible elegir barras de color al 75 % o al 100 % para la señal de ajuste.
- **Audio dBFS:** Permite seleccionar el par de canales de audio que se desea monitorizar.
- **Audio dBVU:** Permite seleccionar el par de canales de audio que se desea monitorizar.

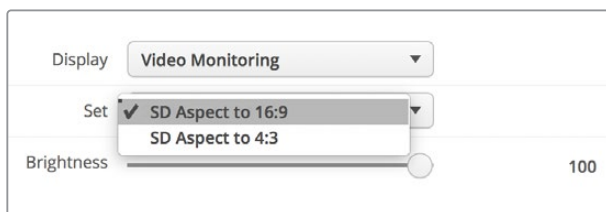

Seleccione la opción **SD Aspect to 16:9** para ver imágenes anamórficas en definición estándar.

Brillo, contraste y saturación

Ajuste los controles **Brightness**, **Contrast** y **Saturation** según los valores deseados. Cabe destacar que dichos ajustes pueden variar de un modelo a otro.

Identificación del monitor

Cuando la casilla **Identify** está marcada, la unidad seleccionada en el programa SmartView Setup mostrará un borde blanco en la pantalla. Esta función permite identificar fácilmente el dispositivo si hay varios conectados a una misma red.

Al emplear esta función junto con la opción **Both Monitors**, el borde blanco aparecerá en ambas pantallas de los modelos SmartView Duo y SmartScope Duo 4K.

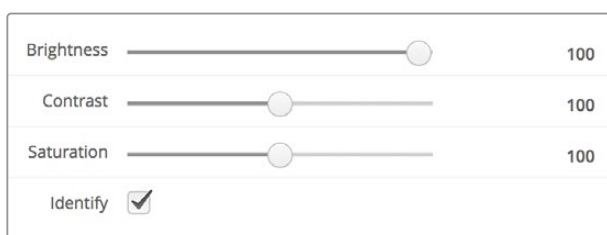

Deslice los controles para ajustar el brillo, el contraste y la saturación. Marque la casilla **Identify** para identificar la unidad seleccionada.

Activar bordes indicadores

Seleccione **Enable Tally Override** para activar los bordes indicadores en el modelo Blackmagic SmartView 4K. Esta opción es compatible con las cámaras Blackmagic URSA Mini Pro 4.6K y Blackmagic URSA Broadcast.

Conecte la salida SDI de la cámara a la entrada A o B del monitor SmartView 4K.

Conecte la salida principal del mezclador ATEM a la entrada SDI de la cámara.

Al transmitir la señal de la cámara mediante la salida principal del mezclador, un borde rojo aparecerá en la pantalla del modelo SmartView 4K. Por el contrario, al seleccionarla como anticipo, el borde será verde.

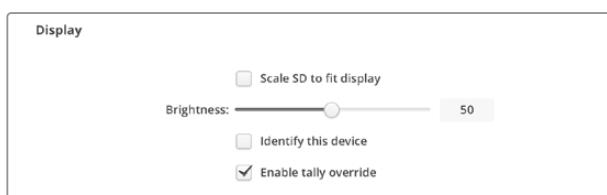

Seleccione la casilla **Enable Tally Override** para ver los bordes indicadores en el modelo SmartView 4K cuando haya una cámara Blackmagic URSA Mini Pro o URSA Broadcast conectada.

SmartView 4K

Introducción

El modelo SmartView 4K es un monitor profesional UHD de 6 U que incluye conectividad SDI 12G y permite ver imágenes con una resolución original de 2160p60. Es compatible con una amplia variedad de formatos y dispone de una pantalla brillante con un amplio ángulo de visión que ofrece una imagen extraordinariamente nítida, a fin de facilitar el enfoque y la monitorización del color.

Diseñado tanto para estudios como exteriores, este modelo es muy sencillo de usar. Incluye conectores laterales y puede colocarse en espacios pequeños, paredes o brazos articulados, gracias a su compatibilidad con soportes tipo VESA. Cabe mencionar que es posible controlar el dispositivo mediante el panel frontal o en forma remota, a través de una red Ethernet.

Las entradas SDI 12G permiten alternar entre dos fuentes distintas, mientras que la conexión para transceptores SFP brinda la posibilidad de utilizar módulos de fibra óptica. Por su parte, la salida SDI 12G facilita la transmisión de señales a otros equipos, y los dos conectores Ethernet hacen posible el uso de redes informáticas para controlar el dispositivo en forma remota. Además, la salida derivada proporciona un medio sencillo de conectar varias unidades en serie. Este modelo incluye asimismo una conexión para luces piloto que resulta de gran utilidad durante producciones en directo y un puerto USB para actualizar el sistema operativo interno.

El programa SmartView Setup permite aplicar tablas de conversión 3D (.cube) convencionales o creadas en DaVinci Resolve. De esta forma, al conectar una cámara al monitor, es posible ver cómo quedarían las imágenes una vez realizado el etalonaje. Por otra parte, los dos niveles del indicador de enfoque brindan la oportunidad de lograr una nitidez extraordinaria. A su vez, el equipo puede alimentarse mediante corriente alterna o continua, lo cual facilita el uso de baterías externas para ofrecer una mayor portabilidad.

El modelo SmartView 4K es la solución ideal para supervisar contenidos audiovisuales en distintas definiciones a una resolución máxima de 3840 x 2160.



NOTA: Al conectar una fuente de alimentación externa a la entrada para corriente continua, compruebe que esta sea capaz de suministrar una potencia de 24 vatios a 12 voltios.

Botones del panel de control

Los botones en la parte frontal del dispositivo permiten modificar diversos ajustes con rapidez.

Entrada

El botón **INPUT** permite alternar entre las fuentes conectadas a las dos entradas SDI 12G del dispositivo o al transceptor óptico SFP. Si no se detecta una señal, la pantalla mostrará una imagen en negro. Al cambiar de una entrada a otra, se indica brevemente el formato de la señal en la esquina superior izquierda del monitor.

Pantalla

El botón **DISP** permite aumentar o disminuir el brillo de la pantalla presionando las flechas correspondientes. Oprima dicho botón nuevamente para salir.

Datos auxiliares

El botón **H/V DELAY** permite confirmar rápidamente la presencia de datos auxiliares integrados en la señal SDI. Presiónelo una vez para ver la información contenida en el intervalo de supresión horizontal. Oprímalo nuevamente para ver los datos en el intervalo de supresión vertical, tales como subtítulos opcionales (CC).

Solo azul

El ruido en una señal digital se manifiesta principalmente en el canal azul. Para comprobarlo, presione el botón **BLUE ONLY**. Este permite ver dicho canal representado como una imagen en blanco y negro que también puede utilizarse para verificar el enfoque de la cámara.

Distancia focal

El botón **ZOOM** permite mejorar el enfoque de la cámara. Presiónelo para acercar la imagen en la pantalla, a fin de poder comprobar si algún objeto determinado se encuentra fuera de foco. Oprima este botón nuevamente para regresar al modo de visualización habitual.

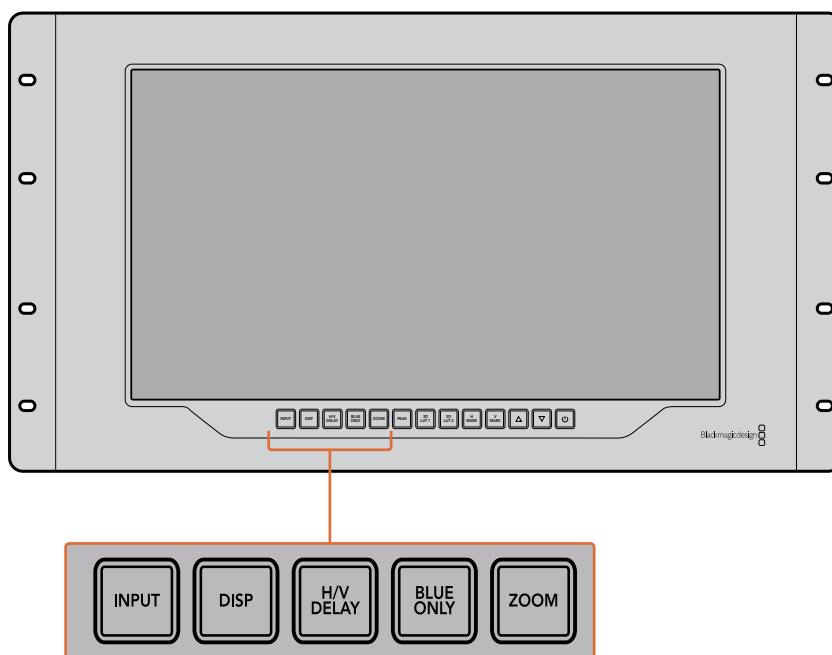

Indicador de enfoque

El botón **PEAK** permite activar el indicador de enfoque, que muestra un borde verde brillante en torno a los puntos más nítidos de la imagen. Al oprimirlo, también es posible alternar entre los dos niveles disponibles. Cuando el color del borde es más intenso, la cámara está enfocada correctamente.

LUT 3D

Los botones **3D LUT 1** y **3D LUT 2** permiten aplicar tablas de conversión convencionales (.cube) o creadas en DaVinci Resolve. Presiónelos para activar o desactivar una tabla determinada. Consulte el apartado "Aplicar LUT 3D con SmartView Setup" para obtener más información al respecto.

Guía vertical / horizontal

Los botones **H MARK** y **V MARK** permiten ver las guías de encuadre y cambiar su posición. Estas líneas facilitan la composición de planos para mantener ciertos elementos gráficos o información importante dentro del área visible de la pantalla. La imagen grabada puede ser levemente mayor o menor a la superficie de la pantalla de un televisor. El área de seguridad corresponde a la parte de la señal que siempre es visible, independientemente del monitor o televisor utilizado.

Presione el botón **H MARK** o **V MARK** para ver el margen horizontal o vertical, respectivamente. Oprímalos una vez más para cambiar su posición. A continuación, utilice las flechas para desplazarlo. Para confirmar, presione nuevamente el botón correspondiente. Oprímalos una vez más para ocultar las guías.

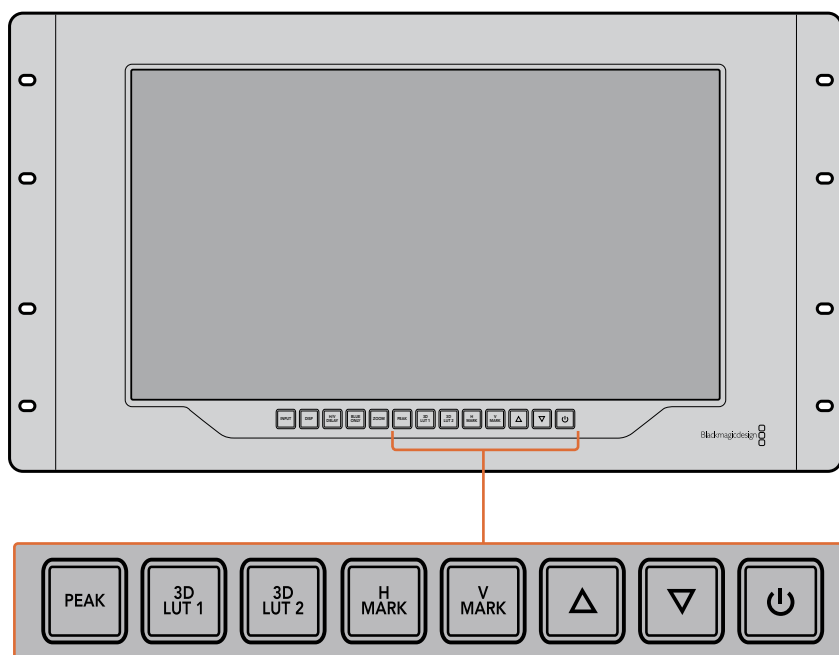

Flechas

Las flechas permiten cambiar diferentes parámetros, tales como el brillo de la pantalla o la posición de las guías.

Encendido

Presione el botón de encendido una vez para prender el dispositivo. Oprímalo nuevamente para apagarlo.

Aplicar LUT 3D con SmartView Setup

El modelo SmartView 4K permite supervisar imágenes aplicando tablas de conversión tridimensionales. Esto brinda la posibilidad de calibrar el dispositivo o apreciar cómo se vería el producto final una vez realizado el etalonaje. A su vez, las tablas proporcionan una manera rápida de probar distintas apariencias. Estas se aplican por medio del programa SmartView Setup, que ofrece la oportunidad de emplear archivos con extensión **.cube** o versiones creadas en DaVinci Resolve. Consulte el manual de DaVinci Resolve para obtener más información al respecto.

Para aplicar una tabla de conversión:

- 1 Ejecute el programa SmartView Setup.
- 2 Haga clic en el botón **Load** junto a la opción **Load LUT 1**. Se abrirá una ventana para elegir el archivo que contiene la tabla. Una vez seleccionado, haga clic en el botón **Open**.
- 3 Para aplicar la tabla seleccionada, presione el botón **3D LUT 1** en el panel frontal del dispositivo. Para desactivarla, oprima dicho botón nuevamente.

Repita el mismo procedimiento para aplicar una segunda tabla de conversión tridimensional mediante la opción **Load LUT 2**.

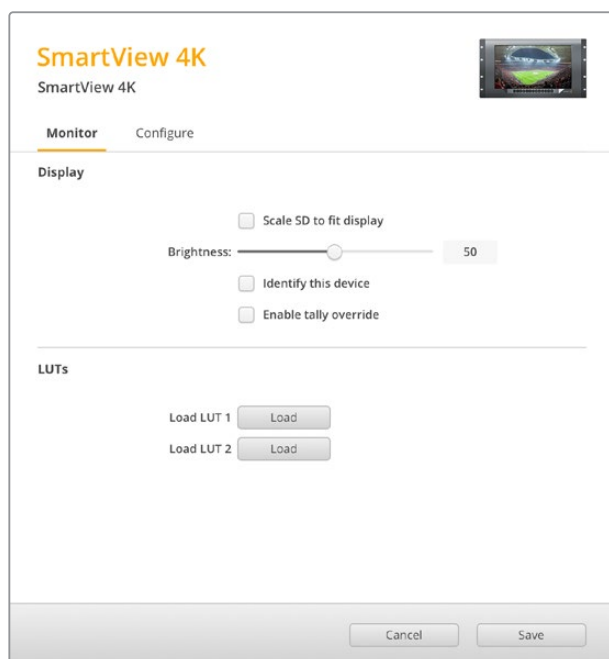

El programa SmartView Setup permite aplicar tablas de conversión tridimensionales a las imágenes visualizadas en el dispositivo.

SmartScope Duo 4K

¿Qué es Blackmagic SmartScope?

Antes los instrumentos para medir los diferentes aspectos de una señal audiovisual en estudios de televisión y posproducción eran extraordinariamente caros y solo permitían ver un aspecto de la misma en una pantalla muy pequeña. Además, algunos de estos dispositivos son desagradables y no lucen bien frente al cliente.

El modelo SmartScope Duo 4K ofrece la posibilidad de ver cualquier aspecto de la señal al instante en dos monitores. Los ajustes realizados en la fuente mediante el programa SmartView Setup pueden apreciarse inmediatamente en las pantallas del dispositivo. Asimismo, la señal recibida puede transmitirse a cualquiera de ellas a través de la salida SDI derivada, lo cual permite ver las imágenes en el monitor izquierdo y las representaciones gráficas correspondientes en el derecho.

Los diferentes indicadores disponibles se seleccionan mediante el programa SmartView Setup desde el menú desplegable **Display**.

A continuación se brinda una descripción más detallada de las representaciones gráficas y la forma en que facilitan la supervisión de las señales.

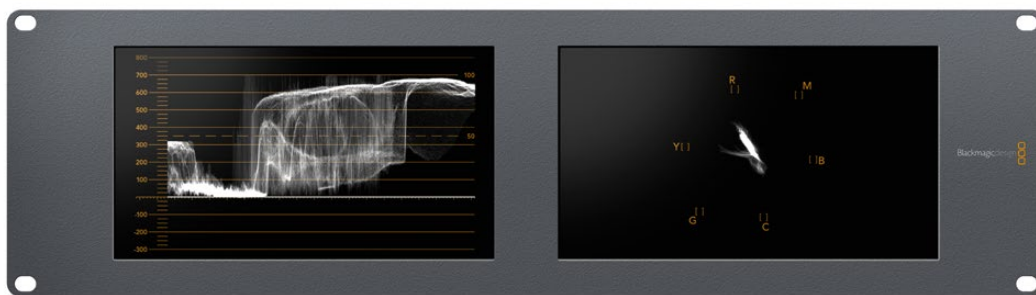

El programa SmartView Setup permite ver representaciones gráficas diferentes en cada pantalla del dispositivo.

Imágenes

La opción **Video Monitoring** permite ver las imágenes correspondientes a la señal recibida.

Si su definición es estándar, es posible seleccionar una relación de aspecto de 4:3 o 16:9 desde el menú desplegable **Set**. Cualquier variación del brillo, el contraste o la saturación se aprecia inmediatamente en la pantalla. Cabe mencionar que estos ajustes solo afectan al monitor y no a la imagen en sí misma. Por lo tanto, no se observarán cambios en las representaciones gráficas.

Puede resultar útil emplear una de las pantallas para supervisar las imágenes y la otra para ver los indicadores. A tales efectos, conecte un cable corto desde la salida SDI derivada del monitor 1 a la entrada correspondiente del monitor 2.

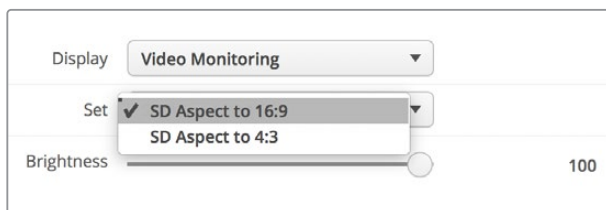

Las imágenes en definición estándar pueden verse con una relación de aspecto de 4:3 o 16:9 eligiendo la opción correspondiente en el menú **Set**. Seleccione **SD Aspect to 16:9** para contenidos anamórficos.

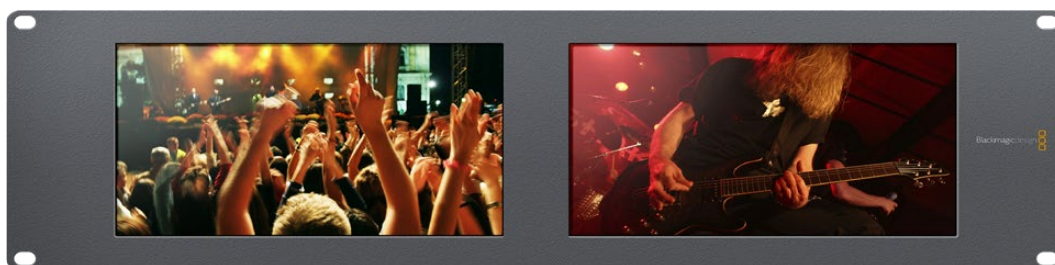

La opción **Video Monitoring** permite observar la señal tal como se vería normalmente en la pantalla de un monitor o televisor.

Forma de onda

La opción **Waveform** permite ver la onda de la señal codificada digitalmente, en forma similar a un osciloscopio tradicional, a fin de ajustar el brillo de la imagen.

Los monitores de luminancia convencionales solo ofrecen la posibilidad de supervisar señales analógicas compuestas en definición estándar. Sin embargo, el modelo SmartScope Duo 4K también admite imágenes HD y UHD, facilitando de esta manera el ajuste del brillo en señales con diversos formatos.

Seleccione la opción **Waveform** en el menú desplegable **Display** del programa SmartView Setup. Compruebe que los valores para el color negro no caigan por debajo de 0 %, y que aquellos correspondientes al blanco no superen el 100 %, a fin de garantizar que la luminancia se encuentre dentro del rango permitido.

Esta representación gráfica muestra los valores del brillo en las distintas partes de la imagen. Por ejemplo, si una parte del cielo está sobreexpuesta, se reflejará en la misma posición horizontal en la gráfica.

La forma de onda será diferente según el material grabado. Si este es de alto contraste, es posible que no se aprecien valores en los tonos grises intermedios. La siguiente ilustración muestra la gráfica correspondiente a una imagen cuya exposición es pareja, con una zona oscura a la izquierda y mayor brillo desde el centro hacia la derecha.

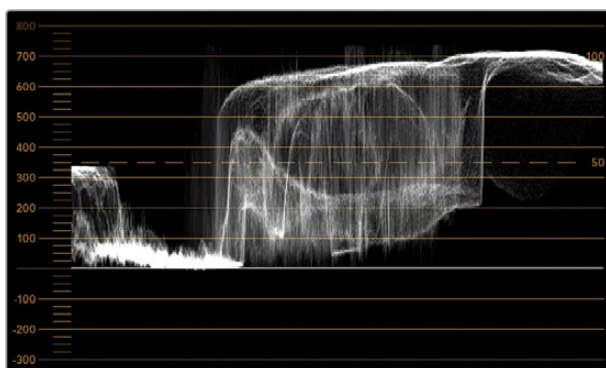

Representación gráfica de la luminancia en la imagen

Adjust	<input checked="" type="radio"/> Left Monitor
	<input type="radio"/> Right Monitor
	<input type="radio"/> Both Monitors
Display	Waveform ▼
Set	No Options ▼

Seleccione la opción **Waveform** en el menú desplegable **Display** para ver una representación gráfica de la luminancia en la señal.

Vectorscopio

Como su nombre lo indica, esta es una representación vectorial de los colores presentes en la señal. Seleccione la opción **100 %** o **75 %** en el menú desplegable **Set** según la carta de ajuste utilizada.

A pesar de que algunas personas piensan que es posible identificar valores cromáticos no adecuados mediante el vectorscopio, esto no es así. Para ello, es necesario recurrir a la gráfica de colores primarios. La razón por la cual el vectorscopio no resulta apropiado a tal fin es que se necesitan tanto parámetros de crominancia como de luminancia. Por ejemplo, los colores cercanos a las partes blancas o negras de la imagen tienen menos posibilidades de saturarse que aquellos más intensos utilizados en los tonos intermedios. Dado que esta representación no indica los valores de luminancia sino solo los matices cromáticos, no permite determinar si existen niveles de color inadecuados.

El vectorscopio es una herramienta ideal para comprobar dichos niveles en señales analógicas cuando es necesario ajustar la crominancia. Basta con reproducir el segmento de la secuencia que contiene las barras de color y luego ajustar el matiz y la crominancia según las casillas en la gráfica.

Asimismo, este indicador resulta óptimo al llevar a cabo el etalonaje, ya que permite determinar si el balance de blancos es adecuado. En caso de que exista cierto matiz cromático, la gráfica se alejará del centro y posiblemente aparezcan dos puntos centrales. En general, el intervalo de supresión en la señal generará un punto en el centro del vectorscopio, dado que corresponde a una parte de la imagen completamente oscura. Este constituye un punto de referencia útil que facilita el reconocimiento de las áreas sin información cromática.

Si la imagen presenta algún matiz, la representación gráfica se alejará de los puntos de referencia y del centro. La magnitud del cambio es proporcional al grado del matiz y se puede apreciar tanto en las zonas claras como oscuras de la imagen. Por esta razón, el vectorscopio resulta de gran ayuda para eliminar cualquier tonalidad y lograr un balance de blancos adecuado.

Por otra parte, el vectorscopio permite incrementar la intensidad de los colores sin agregar matices no deseados a las partes más brillantes y oscuras de la imagen. Aunque tanto la gráfica de colores primarios como el vectorscopio permiten determinar el balance de blancos, este último brinda la oportunidad de identificar posibles problemas con mayor facilidad.

Al corregir los tonos de piel, especialmente en los rostros, los valores correspondientes a la saturación de los colores cálidos deben reflejarse a lo largo de una línea que apunta aproximadamente a la hora 10. Esta línea, conocida como "flesh tone line", se basa en el color de la sangre debajo de la superficie de la piel. Por consiguiente, este método puede aplicarse a cualquier tipo de pigmentación y es la mejor manera de asegurarse de que los tonos de piel luzcan naturales.



Imagen del vectorscopio que muestra la representación gráfica de los tonos de piel



Seleccione la opción **100 %** o **75 %** en el menú desplegable **Set** del programa SmartView Setup.

Luminancia y crominancia

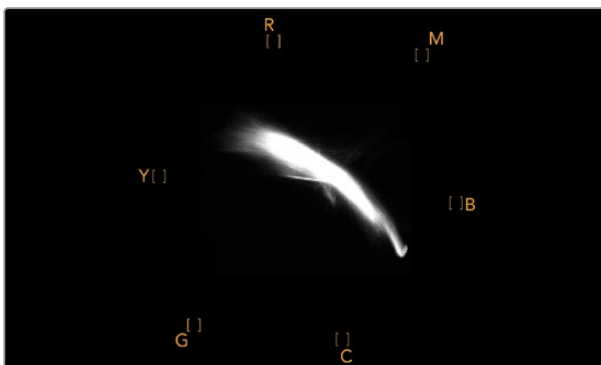
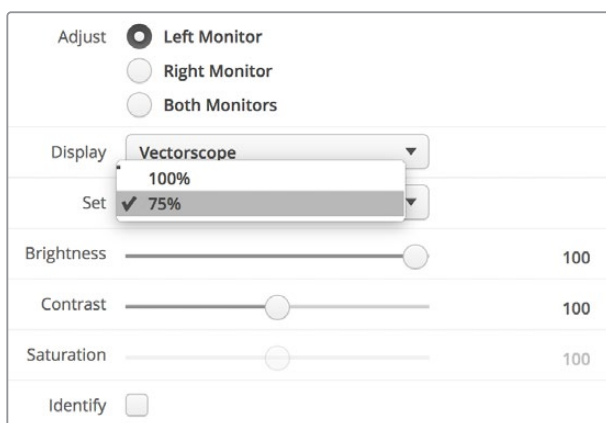
Las gráficas RGB y YUV son ideales para establecer niveles cromáticos adecuados.

Al realizar el etalonaje, seleccione la opción **RGB Parade** en el menú desplegable **Display** del programa SmartView Setup. Esta permite ver una representación de los canales rojo, verde y azul que hace posible determinar sus niveles, facilitando de este modo la comprobación del balance de color en las zonas más claras y oscuras de la imagen, así como en los tonos intermedios. A su vez, esto brinda la oportunidad de identificar problemas comunes a los tres canales, simplificando de esta forma la eliminación de matices no deseados.

Al etalonar las imágenes, es importante aprovechar al máximo el rango cromático sin excederse de los límites permitidos. Si desea aumentar los niveles, compruebe que no superen el límite superior de la gráfica. Aunque algunos dispositivos no permiten establecer valores fuera de dicho rango, otros no cuentan con esta función. El modelo SmartScope Duo 4K ofrece la posibilidad de determinar si los parámetros son adecuados.

Lo mismo sucede con los valores para el blanco y el negro. Algunos sistemas de etalonaje permiten disminuir el nivel del negro por debajo de 0 %. Si observa un nivel de negro inadecuado, ajuste la ganancia, pero también compruebe la retícula para verificar que no se hayan alterado los valores de las zonas más claras de la imagen.

Para ver la gráfica de luminancia, seleccione la opción **YUV Parade** en el menú desplegable **Display**. Esta es de suma utilidad, puesto que el brillo está separado del color y, por otra parte, es el formato que se emplea en la teledifusión de material audiovisual. La primera forma de onda situada a la izquierda brinda información sobre la luminancia; la segunda y la tercera, sobre la crominancia. Esta gráfica es ideal para calibrar una señal empleando barras de color como carta de ajuste, de manera que los colores se representen con precisión, para que el contenido transmitido pueda verse en cualquier televisor.

Cabe destacar que es necesario realizar ajustes cromáticos constantemente, a fin de lograr la mejor calidad de imagen, sin excederse de los niveles permitidos.

Terminología

Negro – Intensidad del color negro en la señal.

Tonos intermedios – Intensidad de los tonos grisáceos en la señal.

Blanco – Intensidad del color blanco en la señal.

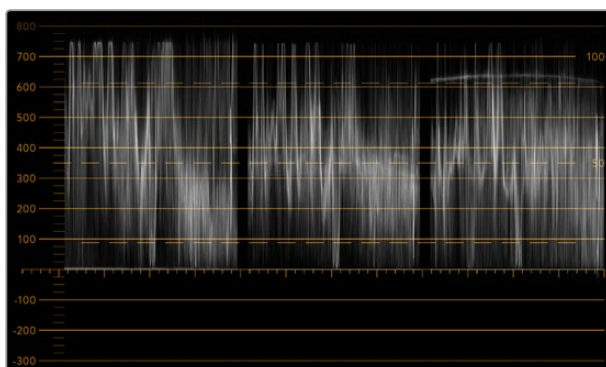

Gráfica RGB

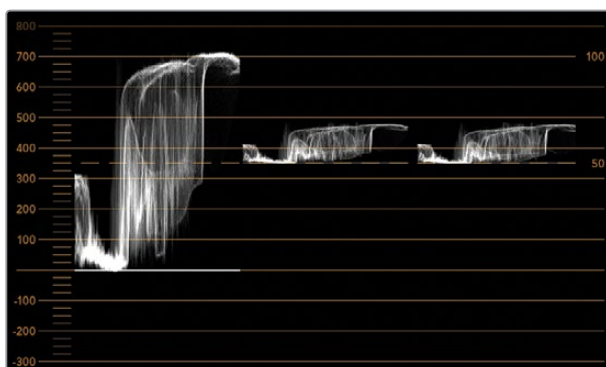

Gráfica YUV

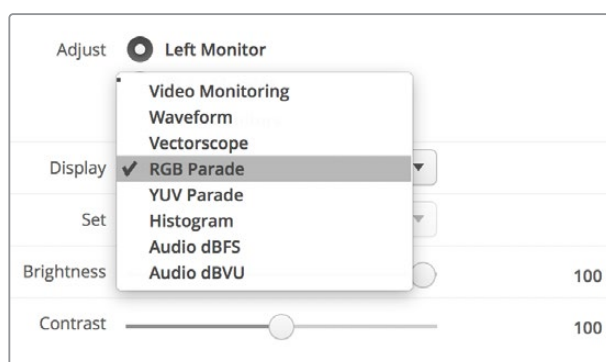

Las opciones **RGB Parade** y **YUV Parade** están disponibles en el menú **Display**.

Histograma

Este indicador es el más utilizado por los diseñadores gráficos y operadores de cámara. Muestra la distribución del blanco y el negro, y permite comprobar qué tan cerca se está de perder información en la imagen. Asimismo, permite ver el efecto causado al modificar los tonos intermedios de la imagen.

Las zonas más oscuras corresponden a la izquierda de la gráfica, y las más claras, a la derecha. Generalmente, la señal debe permanecer dentro del rango 0–100 %. Fuera de este, se perderá información en la imagen. Es preciso evitar que esto suceda durante el rodaje, ya que los detalles de las zonas más claras y oscuras deben conservarse para poder realizar ajustes cromáticos posteriormente en un entorno controlado. Durante la filmación, es necesario mantener la señal dentro del rango mencionado, a fin de tener mayor flexibilidad a la hora de ajustar los colores sin que el blanco o el negro luzcan apagados.

Al etalonar material audiovisual, a veces se permite que los valores se sitúen fuera de dicho rango para lograr un cierto efecto, en cuyo caso el histograma mostrará el resultado del cambio, indicando además cuánta información se pierde. Asimismo, es posible ajustar los tonos intermedios para crear una apariencia similar conservando más detalles.

De hecho, es posible recurrir al histograma para comprobar todos los valores de la imagen, sino solo aquellos correspondientes al blanco y al negro. El histograma no brinda información cromática, por lo cual puede indicar niveles normales cuando en realidad los valores de la imagen son inadecuados. Como se mencionó anteriormente, la gráfica de componentes cromáticos (o RGB) es la herramienta ideal para comprobar dichos niveles, ya que indica tanto la crominancia como la luminancia de la señal.

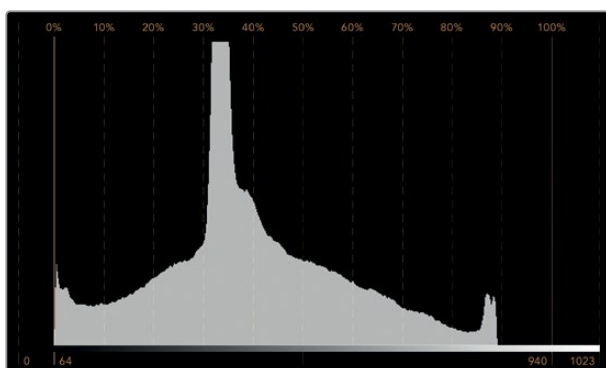

El histograma muestra las zonas más claras y oscuras de la imagen.

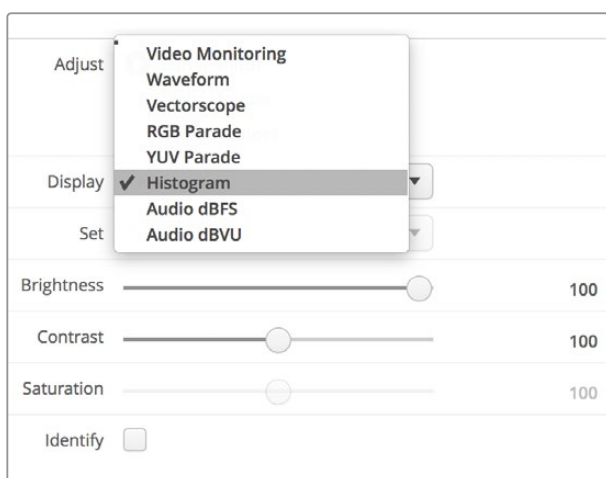

Seleccione la opción **Histogram** en el menú desplegable **Display** del programa SmartView Setup.

Medición del audio

Este modo de visualización indica la intensidad del audio integrado en la señal SDI. Permite ver información sobre un máximo de 16 canales en decibelios a escala completa o en formato VU.

El vúmetro indica el nivel promedio de la señal y es más común en dispositivos de mayor antigüedad. Está calibrado según la recomendación de la SMPTE, con un volumen predeterminado de -20 dBFS para un tono de 1 kHz (señal de prueba).

Esta unidad de medida permite medir la señal de audio digital en general y es común en equipos más modernos.

El indicador derecho brinda la posibilidad de monitorizar dos canales de audio seleccionándolos en el menú desplegable **Set**. La información se presenta en un gráfico que permite identificar problemas en el balance del audio y determinar si la señal está desfasada, o si una determinada pista es monoaural o estéreo. El audio monoaural debería aparecer representado como una línea vertical. Una horizontal indica que el audio está desfasado, y la señal podría perderse al ser recibida por otro equipo. Este es uno de los problemas más comunes en grandes instalaciones donde los cables pueden estar mal conectados.

Al monitorizar señales en estéreo, la línea a la derecha del indicador se despliega a modo de abanico para representar las diferencias entre los canales izquierdo y derecho. La forma que dicha línea adoptará será más circular si la pista de audio es más estereofónica. En caso contrario, la gráfica tenderá a concentrarse alrededor del eje vertical.

Generalmente los diálogos se ven como una línea vertical, mientras que en el caso de música en estéreo, la gráfica se extenderá. Esto se debe a que el audio monoaural (L+R) se muestra sobre el eje vertical, mientras que el sonido en estéreo (L-R) se representa sobre el eje horizontal para indicar la diferencia entre ambos canales.

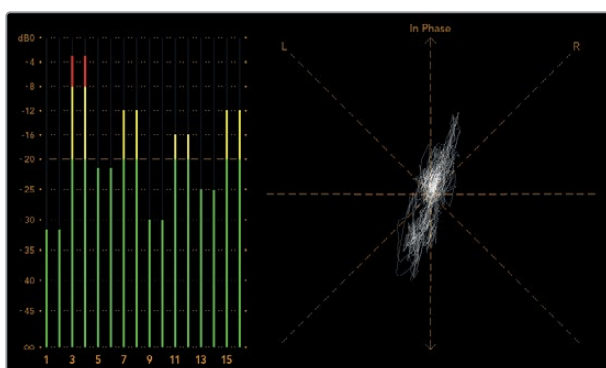

El vúmetro muestra los picos en la señal y el balance de audio.

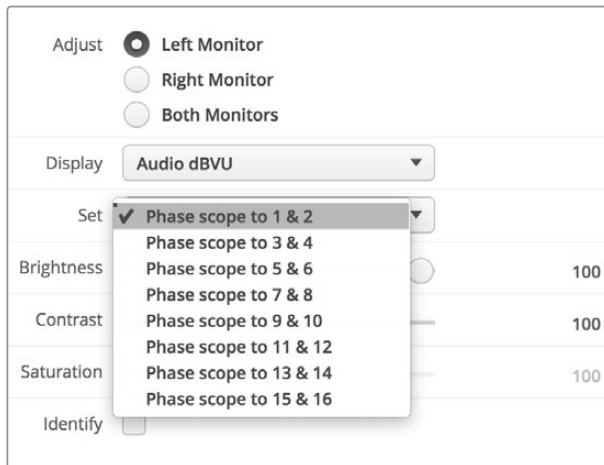

En el menú **Set**, seleccione el par de canales que desea monitorizar.

Conexión a redes

Al conectar un monitor SmartView o SmartScope a una red, es posible realizar ajustes en varias unidades remotamente.

Aunque no es necesario configurar los dispositivos para ver una señal en la pantalla, es preciso verificar los ajustes de la red en forma previa. Esto solo es posible mediante una conexión USB directa al equipo informático.

Conexión Ethernet directa

El monitor puede configurarse remotamente mediante una conexión Ethernet directa al equipo informático. No es necesario utilizar un conmutador de red, lo cual permite instalar el dispositivo rápidamente. Cabe destacar además que es posible conectar varias unidades en serie mediante el puerto Ethernet de cada una. Nótese que todas ellas deberán contar con suministro eléctrico.

En caso de no disponer de una red, o para utilizar varias unidades sin direcciones IP, conéctelas directamente al puerto Ethernet del equipo informático. Esto ofrece una manera rápida de conectar unidades SmartView y SmartScope, dado que no es necesario emplear cables adicionales ni un conmutador de red.

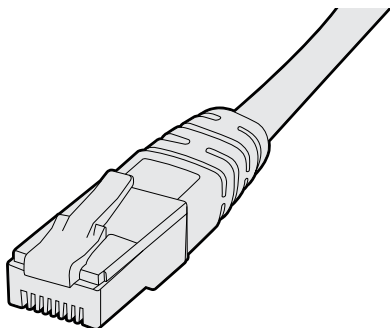

Conector Ethernet

Conmutador de red

Para utilizar varias unidades en una misma red, es suficiente con conectar un monitor SmartView o SmartScope al conmutador de red. El resto puede conectarse en serie mediante el puerto Ethernet de cada unidad, a fin de ocupar solo una conexión en el conmutador. De esta forma, es posible prescindir del uso de cables adicionales. Nótese que todas las unidades deberán contar con suministro eléctrico.

Un conmutador facilita la configuración de las unidades desde cualquier equipo informático conectado a la red. Asimismo, si esta incluye un punto de acceso inalámbrico, es posible lograr este cometido desde cualquier equipo Mac o Windows.

Siga los pasos descritos a continuación para conectar un monitor SmartView o SmartScope a una red IP local.

- 1 Conecte la fuente de alimentación de la unidad y enciéndala.
- 2 Conecte la unidad a un conmutador de red o directamente a un equipo informático mediante un cable RJ-45.

Diagrama de conexión

Es posible conectar el puerto Ethernet de una unidad directamente al equipo informático sin un conmutador de red. Las unidades restantes pueden conectarse en serie, lo cual permite prescindir del uso de cables adicionales. Nótese que todas ellas deberán contar con suministro eléctrico.



Diagrama de conexión con un conmutador de red

Para utilizar varias unidades en una misma red, es suficiente con conectar solo una de ellas al conmutador. Las restantes pueden conectarse en serie, lo cual permite prescindir del uso de cables adicionales. Nótese que todas ellas deberán contar con suministro eléctrico.

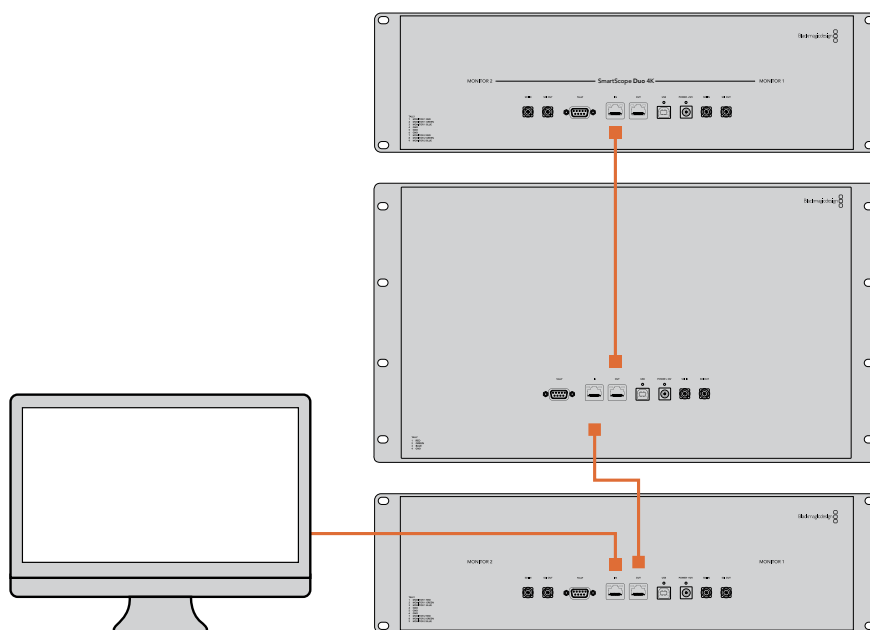
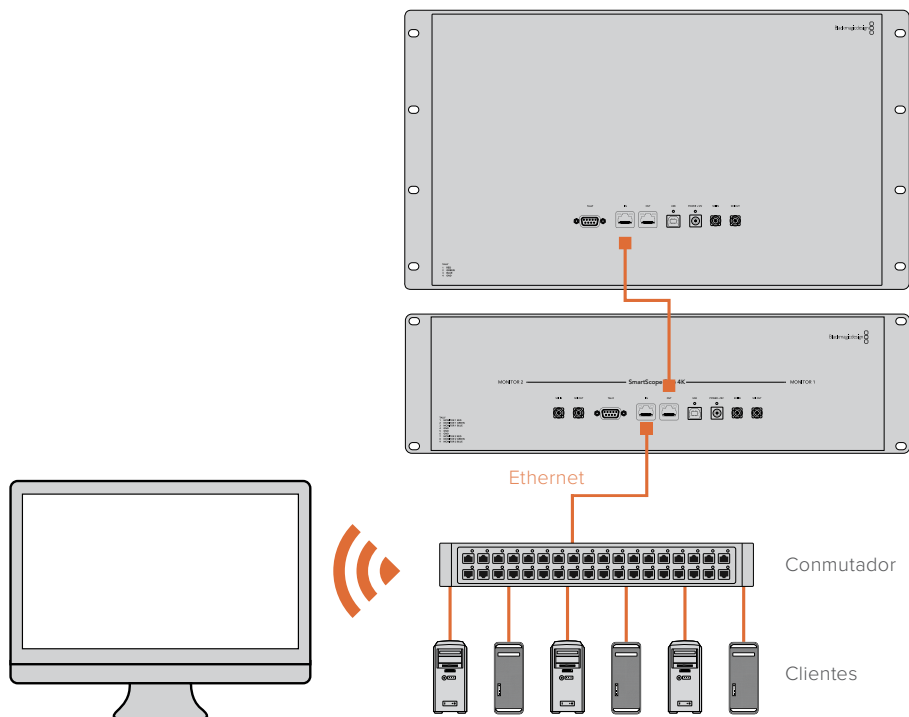

Ajustes de red

Configuración de la red

Nombre del dispositivo

Es recomendable cambiar el nombre de cada monitor a fin de facilitar la identificación de las unidades en la red.

Para ello, compruebe que el monitor esté conectado mediante un puerto USB o Ethernet. Ejecute el programa SmartView Setup y haga clic en el ícono de configuración debajo del nombre del monitor. En la pestaña **Configure**, haga clic sobre el nombre del monitor en el panel **Details** para cambiarlo. Si el nombre no es válido, aparecerá un ícono de advertencia. De lo contrario, verá un visto verde junto al mismo. Presione la tecla de retorno en el equipo informático para confirmar el cambio.

Configuración de la red

Para cambiar la configuración de red, el monitor debe estar conectado al equipo informático. Cabe destacar que no es posible llevar a cabo este procedimiento mediante una conexión Ethernet.

De forma predeterminada, los dispositivos SmartView y SmartScope obtienen una dirección IP automáticamente a través de la red, por medio del protocolo DHCP.

Si no cuenta con este protocolo, active la función **Compartir Internet** en macOS o **Conexión compartida a Internet** (ICS) en Windows 8.1 o Windows 10 para asignar direcciones DHCP a las unidades conectadas. De este modo, no será necesario asignar una dirección IP fija a cada una de ellas. Dicha función permite asignar direcciones IP incluso si el equipo informático no está conectado a Internet. Consulte la documentación relativa a los sistemas operativos mencionados para obtener más información al respecto.

Si no es posible emplear un protocolo DHCP para la configuración, utilice direcciones IP fijas. Solicite una al administrador del sistema para evitar conflictos en la red. Cabe señalar que es preciso indicar una dirección IP única para cada SmartView y SmartScope, así como una máscara de subred común. No es necesario cambiar los valores del campo **Gateway**, a menos que se proponga conectar las unidades a una puerta de enlace.

Si no se detecta ningún dispositivo en la red, es posible que las unidades no hayan recibido una dirección IP mediante el protocolo DHCP, en cuyo caso será necesario configurar los ajustes correspondientes en cada una de ellas.

- 1 Conecte el monitor al equipo informático mediante un cable USB y ejecute el programa SmartView Setup.
- 2 La ventana principal del programa mostrará el dispositivo conectado y el ícono de la conexión USB junto a su nombre.
- 3 Cambie la configuración de la red.
- 4 Repita este procedimiento para las restantes unidades que no hayan recibido una dirección IP mediante el protocolo DHCP.

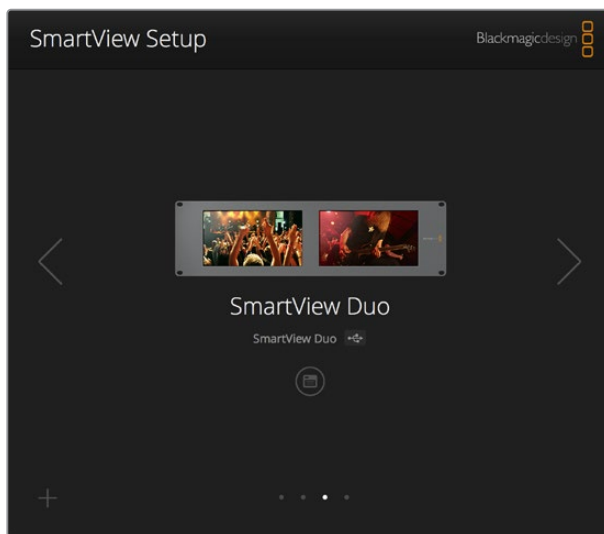

El ícono junto al nombre del dispositivo indica que está conectado al equipo informático a través del puerto USB. Esto es necesario para poder cambiar la configuración de red.

The screenshot shows a configuration window for a monitor named 'SmartView Duo'. The window is divided into sections: 'Details' and 'Network Settings'. Under 'Details', the name is 'SmartView Duo' and the software version is '4.0.1'. Under 'Network Settings', the IP setting is set to 'Static IP' (indicated by a selected radio button). The IP address is '192.168.10.42', the subnet mask is '255.255.255.0', and the gateway is '192.168.10.1'. A green checkmark is visible next to the IP address field. At the bottom of the window are 'Cancel' and 'Save' buttons.

Al configurar la red, es posible utilizar el protocolo DHCP o direcciones IP fijas. Nótese que los ajustes solo se pueden modificar a través de la conexión USB.

Agregar monitores a la red

Si conoce la dirección IP del monitor, es posible agregarlo a la red manualmente en caso de que no aparezca en la ventana principal del programa SmartView Setup. Para ello, siga los pasos descritos a continuación.

- 1 Compruebe que el monitor esté conectado mediante el puerto Ethernet. Haga clic en el símbolo + situado en la esquina inferior izquierda de la interfaz para abrir la ventana que permite añadir unidades.
- 2 Escriba la dirección IP del monitor y haga clic en el botón **Add**.
- 3 El programa verificará la presencia del monitor y lo agregará a la lista de unidades conectadas. Haga clic sobre la flecha derecha para ver el monitor agregado.

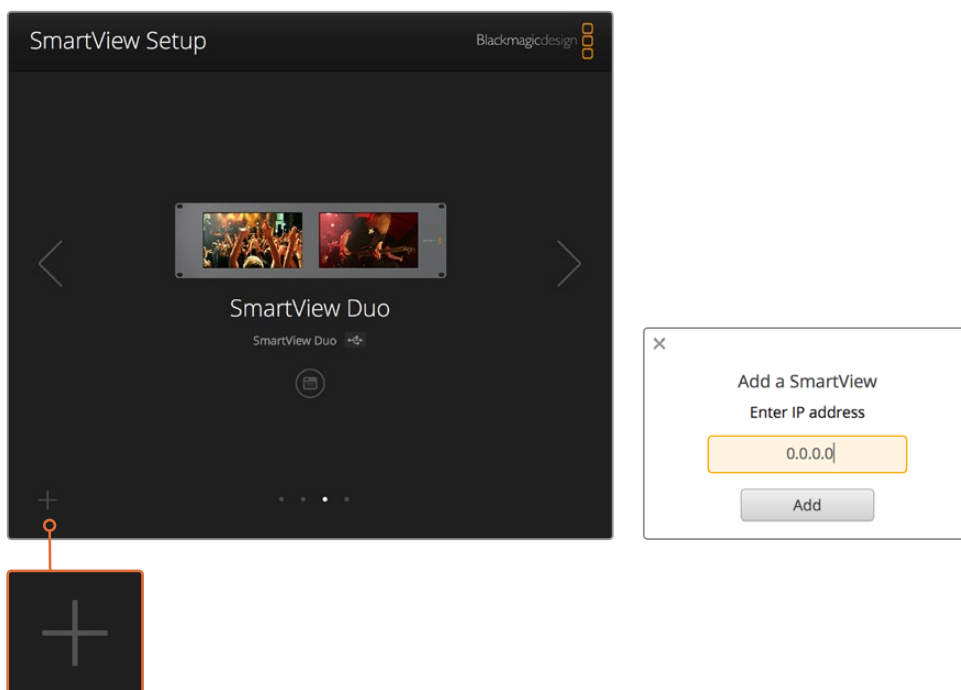

Es posible agregar un monitor a la lista de unidades conectadas haciendo clic en el símbolo + para introducir su dirección IP.

Sistemas de señalización

Conexión

No es necesario conectar la salida **TALLY** de los monitores ni leer este apartado si no pretende utilizar esta función.

Cada dispositivo indica el estado de la señal al aire mediante un borde rojo, verde o azul alrededor de la pantalla.

La conexión D de nueve pines admite señales provenientes de mezcladores y sistemas de automatización. Consulte el diagrama ilustrado a continuación para obtener más información al respecto.

El diagrama de conexión está impreso en la parte posterior de la unidad y describe cada uno de los contactos que permiten utilizar el sistema de señalización.

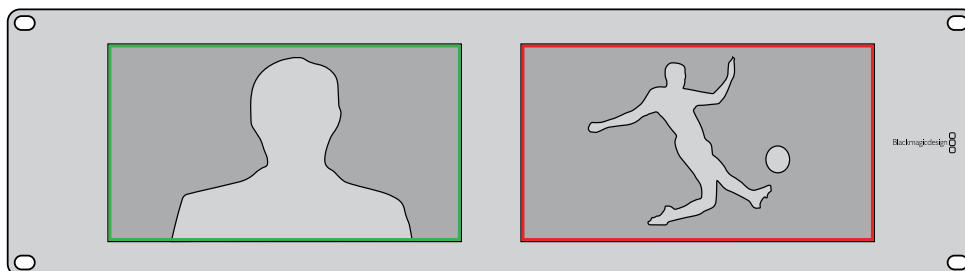

Modelo SmartView Duo con bordes indicadores alrededor de cada pantalla

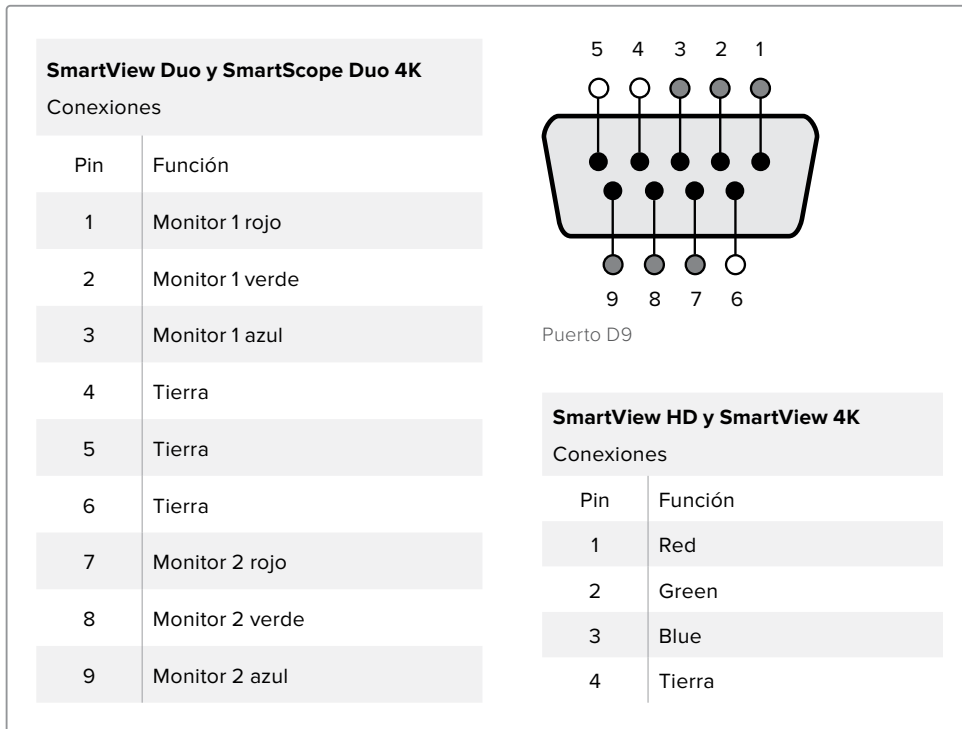

Mejora del ángulo de visión

Cuando el monitor se instala en la parte superior de un bastidor, es posible invertir la pantalla para mejorar el ángulo de visión. En este caso, las imágenes se ajustarán automáticamente según la orientación del dispositivo. Es necesario contar con un destornillador Pozidriv 02 para desmontar y volver a colocar la parte frontal de la unidad. Este es un procedimiento sumamente sencillo que no requiere la apertura de la parte trasera.

A continuación se describe la forma de invertir la unidad manteniendo a su vez el logotipo de Blackmagic en la posición correcta. Nótese que es necesario contar con un destornillador Pozidriv 02.

- 1 Quite los tornillos situados en la parte superior, inferior, izquierda y derecha de la testera. Los modelos SmartView Duo y SmartScope Duo 4K incluyen 10 tornillos, y la versión SmartView HD tiene 18.
- 2 Separe la testera de la parte trasera de la unidad, como se ilustra en la figura.
- 3 Gire la parte trasera de la unidad.
- 4 Instale nuevamente la testera.
- 5 Coloque los tornillos nuevamente y apriételes.

El dispositivo está listo para montarse en la parte superior de un bastidor. Una vez instalado, continuará mostrando el ángulo de visión más adecuado, ya que no dispone de mandos o controles externos que puedan desajustarse accidentalmente.



Es recomendable verificar que la imagen se vea correctamente antes de instalar la unidad en el bastidor.

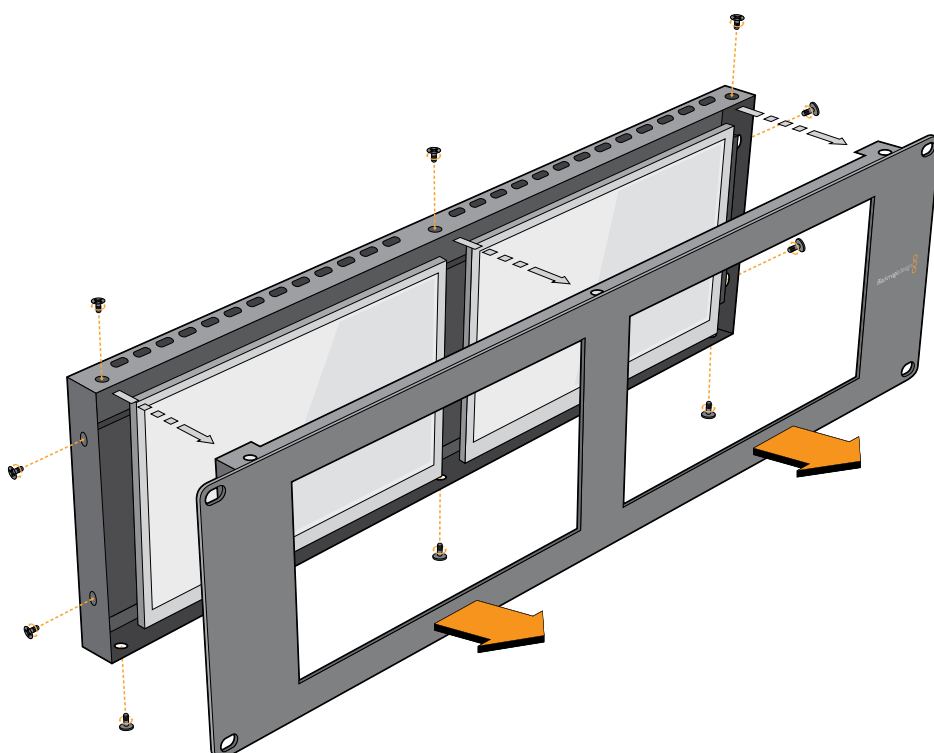

Quite todos los tornillos para separar la testera de la parte trasera de la unidad.

Información para desarrolladores

Desarrollo de aplicaciones personalizadas con productos de Blackmagic Design

El protocolo de Ethernet desarrollado por Blackmagic permite controlar remotamente los dispositivos SmartView y SmartScope mediante aplicaciones informáticas personalizadas. Cabe destacar que se trata de un protocolo basado en texto.

Cómo obtener el protocolo de Ethernet

El protocolo es gratis. Puede descargarse desde la página de soporte técnico de Blackmagic Design y sus funciones principales se describen en este manual.

Lista de desarrolladores de Blackmagic Design

Esta lista de distribución ha sido creada para ayudar a responder dudas técnicas relativas a las diversas tecnologías empleadas por Blackmagic Design. Constituye un foro donde los desarrolladores pueden discutir diferentes ideas con otros colegas y resolver problemas. Cualquier persona suscrita puede intervenir en las distintas discusiones, así como los ingenieros de Blackmagic Design cuando resulte apropiado. Para suscribirse, visite la siguiente página: <http://lists.blackmagicdesign.com/mailman/listinfo/bmd-developer>

En algunos casos, solicitamos que se proporcione una breve descripción de la aplicación si el tipo de software desarrollado no resulta evidente a partir del nombre de dominio. Solo lo hacemos para evitar mensajes no deseados o preguntas de usuarios finales referidas a otras cuestiones, o que la lista se vea afectada por un virus. Conviene subrayar que es una plataforma solo para desarrolladores.

Cómo obtener asistencia

Por otras cuestiones relativas al desarrollo de aplicaciones, o si desea realizar preguntas fuera de la lista, puede escribirnos a la siguiente dirección: developer@blackmagicdesign.com



Formato 2K de Blackmagic – Información general

Los productos de Blackmagic Design permiten procesar señales SDI 3G, las cuales brindan la posibilidad de transmitir datos al doble de velocidad que una señal en alta definición. Pensamos que sería una buena idea que también fueran compatibles con imágenes en resolución 2K, a fin de simplificar las dinámicas de trabajo en la industria cinematográfica. Gracias a la popularidad de los sistemas de edición de Blackmagic Design, ahora miles de personas pueden sacar provecho de las prestaciones que estos ofrecen.

A continuación se proporciona toda la información necesaria para desarrollar equipos compatibles con señales SDI en resolución 2K. Dado que todos nuestros productos pueden actualizarse, también podemos ofrecer compatibilidad con otros formatos que la industria cinematográfica adopte en el futuro.

Estructura de cuadros

- Transmisión a 23.98, 24 o 25 cuadros por segundo en formato PSF.
- Imagen activa: 2048 píxeles x 1556 líneas.
- Total de líneas por cuadro: 1650
- Palabras activas por línea: 1535. Una palabra consta de una muestra de 10 bits para cada uno de los cuatro flujos de datos, es decir, 40 bits en total. Consulte la tabla que figura en la siguiente página.
- Total de líneas activas: 1556
- Total de palabras por línea: 1875 para 23.98/24Hz, y 1800 para 25Hz.
- Campos por cuadro: 2 de 825 líneas cada uno.
- Líneas activas: 16-793 (campo 1) y 841-1618 (campo 2).

Estructura de transporte

- Basada en distribución de señales SMPTE 372M mediante dos enlaces y compatibilidad con el estándar SMPTE 425M-B para transmitir señales SMPTE 372M mediante un enlace 3 Gb/s.
- Señales de referencia, número de línea e inserción CRC, según se describió anteriormente.
- Durante una señal activa, los datos de 10 bits relativos a los colores rojo, verde y azul se envían en la siguiente secuencia:
- Los datos auxiliares opcionales se insertan en ambas interfaces virtuales.
- Actualmente, solo se incluye información relativa al audio. Según la norma SMPTE S299M, los paquetes de audio se transmiten mediante el flujo 2, mientras que los paquetes de control se envían a través del flujo 1.
 - Flujo de datos 1: Green_1, Green_2, Green_3, Green_5... Green_2047
 - Flujo de datos 2: Blue_1, Blue_2, Green_4, Blue_5... Green_2048
 - Flujo de datos 3: Red_1, Blue_3, Blue_4, Red_5... Blue_2048
 - Flujo de datos 4: Red_2, Red_3, Red_4, Red_6... Red_2048

Formato 2K de Blackmagic – Referencia de temporización vertical

El siguiente diagrama brinda información sobre la temporización vertical con los números de línea y los bits relativos al campo, el intervalo vertical y el intervalo horizontal para los códigos de la señal de referencia.

		Campo 1					Activo					
F	1	0	0	0	0	0	0	0	0	0	0	0
V	1	1	1	1	1	1	0	0	0	0	1	1
LÍNEA	1650	1	2	...	14	15	16	...	792	793	...	825

		Campo 2					Activo					
F	0	1	1	1	1	1	1	1	1	1	1	1
V	1	1	1	1	1	1	0	0	0	0	1	1
LÍNEA	825	826	827	...	839	840	841	...	1617	1618	...	1650

Formato 2K de Blackmagic – Transmisión de datos

El siguiente diagrama indica los formatos de los flujos de datos en torno al intervalo de la línea horizontal para datos auxiliares opcionales. Nótese que cada pixel activo ocupa tres muestras.

Word# 25 PsF	Word# 23.98/24 PsF	Data Stream 4	Data Stream 3	Data Stream 2	Data Stream 1
1795	1870	R2042	R2041	B2041	G2041
1796	1871	R2043	B2043	B2042	G2042
1797	1872	R2044	B2044	G2044	G2043
1798	1873	R2046	R2045	B2045	G2045
1799	1874	R2047	B2047	B2046	G2046
1800	1875	R2048	B2048	G2048	G2047
1	1	EAV(3FFh)	EAV(3FFh)	EAV(3FFh)	EAV(3FFh)
2	2	EAV(000h)	EAV(000h)	EAV(000h)	EAV(000h)
3	3	EAV(000h)	EAV(000h)	EAV(000h)	EAV(000h)
4	4	EAV(XYZh)	EAV(XYZh)	EAV(XYZh)	EAV(XYZh)
5	5	LN0	LN0	LN0	LN0
6	6	LN1	LN1	LN1	LN1
7	7	CRC0	CRC0	CRC0	CRC0
8	8	CRC1	CRC1	CRC1	CRC1
9	9	200	040	ANC/Audio Data	ANC/Audio Data
...		
260	335	200	040		
261	336	SAV(3FFh)	SAV(3FFh)	SAV(3FFh)	SAV(3FFh)
262	337	SAV(000h)	SAV(000h)	SAV(000h)	SAV(000h)
263	338	SAV(000h)	SAV(000h)	SAV(000h)	SAV(000h)
264	339	SAV(XYZh)	SAV(XYZh)	SAV(XYZh)	SAV(XYZh)
265	340	R2	R1	B1	G1
266	341	R3	B3	B2	G2
267	342	R4	B4	G4	G3
268	343	R6	R5	B5	G5

Protocolo de Ethernet Blackmagic SmartView v1.3

Resumen

Este protocolo de control basado en texto es muy similar, en cuanto a su estructura, al protocolo para productos Videohub, y se evalúa conectándose al puerto TC 9992 en un dispositivo SmartView o SmartScope.

Una vez conectado, el dispositivo transmite un volcado inicial completo con información sobre su estado. Luego del mismo, los cambios de estado se envían de forma asincrónica.

El dispositivo transmite la información en bloques con un encabezado identificatorio seguido de dos puntos. Cada uno de ellos puede abarcar varias líneas y finaliza con una línea en blanco.

A fin de evitar posibles problemas que pudiesen surgir debido a futuras modificaciones en el protocolo, el cliente deberá ignorar los bloques no reconocidos que figuren antes de la línea en blanco final. Asimismo, es preciso ignorar las líneas que no es posible identificar en cada bloque.

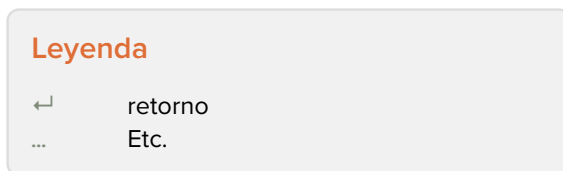

La versión 1.3 de este protocolo se publicó junto con el programa SmartView 1.3.

Preámbulo

El primer bloque que el dispositivo transmite es el preámbulo del protocolo.

```
PROTOCOL PREAMBLE:←  
Version: 1.3 ←  
←
```

El número indica la versión del protocolo. Cuando se efectúan cambios compatibles, el dígito secundario se actualiza. De ser incompatibles, cambia el dígito principal.

Información del dispositivo

El siguiente bloque contiene información sobre el dispositivo conectado.

```
SMARTVIEW DEVICE:←  
Model: SmartView Duo←  
Hostname: stagefront.studio.example.com←  
Name: StageFront←  
Monitors: 2←  
Inverted: false←  
←
```

Este ejemplo hace referencia a un dispositivo SmartView Duo con dos pantallas. El término **Inverted** indica si el monitor se ha girado al montarlo en un bastidor para optimizar el ángulo de visión de la pantalla.

Configuración de red

El siguiente bloque muestra la configuración de la red TCP/IP:

```
NETWORK:↵
Dynamic IP: true↵
Static address: 192.168.2.2↵
Static netmask: 255.255.255.0↵
Static gateway: 192.168.2.1↵
Current address: 192.168.1.101↵
Current netmask: 255.255.255.0↵
Current gateway: 192.168.1.1↵
↵
```

Los ajustes que contienen la palabra **Current** indican la configuración actual de la red y no pueden modificarse. Asimismo, reflejan el uso del protocolo DHCP o de direcciones IP fijas, según el parámetro **Dynamic IP**.

Modificación de los ajustes de red

La red puede configurarse mediante direcciones IP fijas o el protocolo DHCP. Para activar dicho protocolo:

```
NETWORK:↵
Dynamic IP: true↵
↵
```

En el caso de una dirección IP fija, deberá proporcionar todos los parámetros:

```
NETWORK:↵
Dynamic IP: false↵
Static address: 192.168.2.2↵
Static netmask: 255.255.255.0↵
Static gateway: 192.168.2.1↵
↵
```

Los ajustes que contienen la palabra **Current** indican la configuración actual de la red, independientemente del uso de direcciones dinámicas o fijas, y no pueden modificarse.

La conexión se interrumpirá si se cambia el nombre del dispositivo o cualquier otro parámetro de la red. El dispositivo restablecerá la conexión y mostrará el nombre nuevo.

Cambio de los ajustes del monitor

Los ajustes para cada pantalla se especifican individualmente. Es posible modificar uno o varios valores en forma simultánea, así como incluir múltiples parámetros en un mismo bloque.

El rango permitido para valores numéricos es 0-255. El contraste y la saturación se centran en torno al 0, de manera que el valor normal es 127. En este caso, la imagen mostrada es igual a la original. Al incrementar dicho valor, aumentará el contraste o la saturación, y viceversa.

Por ejemplo, para ajustar el brillo a 50 % y desaturar la imagen:

```
MONITOR A:↵
Brightness: 127↵
Saturation: 0↵
↵
```

Visualización de imágenes SD en formato 16:9

El siguiente formato permite ver imágenes en definición estándar con una relación de aspecto de 16:9.

```
MONITOR A:↵  
WidescreenSD: ON↵
```

Visualización de imágenes SD en formato 4:3

El siguiente formato permite ver imágenes en definición estándar con una relación de aspecto de 4:3.

```
MONITOR A:↵  
WidescreenSD: OFF↵
```

Identificación y señalización

La opción **Identify** es transitoria y permite ver un borde blanco en torno a la imagen durante 15 segundos. Su función principal es la de identificar el monitor cuyos ajustes se están modificando cuando hay varias unidades instaladas en un bastidor. Para activarla:

```
MONITOR A:↵  
Identify: true↵  
↵
```

Conviene subrayar que se cancelará cualquier otro parámetro activo correspondiente al borde.

El parámetro **BORDER** puede emplearse a fin de seleccionar un color primario para los bordes identificatorios. Las opciones disponibles son rojo, verde, azul o ninguno. Esta función quedará invalidada por las señales eléctricas recibidas a través de la entrada DB-9 del dispositivo. Por ejemplo, para seleccionar el color verde:

```
MONITOR B:↵  
Border: green↵  
↵
```

Nótese que siempre prevalecerán las señales transmitidas por cable. El informe de estado indica el parámetro válido actual.

Ajustes del modelo SmartScope

En el modelo SmartScope Duo 4K, es posible configurar cada pantalla de forma independiente. A continuación se describen los comandos para activar opciones específicas.

AudioDbfs
AudioDbvu
Histogram
ParadeRGB
ParadeYUV
Picture (corresponde a la imagen principal)
Vector100
Vector75
WaveformLuma

```
MONITOR A:↵  
ScopeMode: Picture↵  
↵
```

En este ejemplo, se ha configurado el monitor A para que muestre la imagen principal.

Visualización de imágenes SD en formato 16:9

Para ver la imagen en definición estándar con una relación de aspecto de 16:9:

```
MONITOR A:↵  
ScopeMode: Picture↵  
WidescreenSD: ON↵
```

Visualización de imágenes SD en formato 4:3

Para ver la imagen en definición estándar con una relación de aspecto de 4:3:

```
MONITOR A:↵  
ScopeMode: Picture↵  
WidescreenSD: OFF↵
```

Al configurar una de las pantallas del modelo SmartScope Duo para mostrar los vúmetros, también es posible seleccionar los canales. A continuación se indican los valores correspondientes.

- 0: Canales 1 y 2
- 1: Canales 3 y 4
- 2: Canales 5 y 6
- 3: Canales 7 y 8
- 4: Canales 9 y 10
- 5: Canales 11 y 12
- 6: Canales 13 y 14
- 7: Canales 15 y 16

```
MONITOR B:↵  
ScopeMode: AudioDbvu↵  
AudioChannel: 0↵  
↵
```

En este ejemplo, se ha configurado el monitor B para que muestre el vúmetro (dbVU) y se han seleccionado los canales 1 y 2 para el medidor de fases.

Selección de tablas de conversión en el modelo SmartView 4K

Para seleccionar una tabla de conversión tridimensional:

```
MONITOR A:↵  
LUT: 0          LUT 1  
      1          LUT 2  
      NONE      DISABLE  
↵  
↵
```

Ayuda

Cómo obtener ayuda

Existen cuatro maneras de obtener ayuda:

- 1** Visite la página de soporte técnico de Blackmagic Design para obtener el material de apoyo más reciente.
- 2** Póngase en contacto con su distribuidor de productos Blackmagic.
- 3** El distribuidor cuenta con las últimas actualizaciones para los productos de la empresa y podrá brindarle asistencia inmediatamente. Asimismo, recomendamos obtener información sobre las distintas opciones que este ofrece para su dinámica de trabajo en particular.
- 4** Otra opción es enviarnos un correo electrónico mediante el botón correspondiente en nuestra página de soporte técnico.
- 5** Comuníquese telefónicamente con una oficina de Blackmagic Design. Para encontrar el centro de atención más cercano, haga clic en el botón **Soporte técnico local**, ubicado en la parte inferior de nuestra página de soporte técnico.

No olvide brindarnos la mayor cantidad de información posible sobre el problema técnico y las especificaciones del sistema para que podamos responderle rápidamente.

Normativas

Tratamiento de residuos de equipos eléctricos y electrónicos en la Unión Europea:



Este símbolo indica que el dispositivo no debe desecharse junto con otros residuos domésticos. A tales efectos, es preciso llevarlo a un centro de recolección para su posterior reciclaje. Esto ayuda a preservar los recursos naturales y garantiza que dicho procedimiento se realice protegiendo la salud y el medioambiente. Para obtener más información al respecto, comuníquese con el distribuidor o el centro de reciclaje más cercano.



Según las pruebas realizadas, este equipo cumple con los límites indicados para dispositivos digitales Clase A, en conformidad con la sección 15 de las normas establecidas por la Comisión Federal de Comunicaciones. Esto permite proporcionar una protección razonable contra interferencias nocivas al operar el dispositivo en un entorno comercial. Este equipo usa, genera y puede irradiar energía de radiofrecuencia, y si no se instala o utiliza de acuerdo con el manual de instrucciones, podría ocasionar interferencias nocivas para las comunicaciones radiales. El funcionamiento de este equipo en una zona residencial podría ocasionar interferencias nocivas, en cuyo caso el usuario deberá solucionar dicho inconveniente por cuenta propia.

El funcionamiento de este equipo está sujeto a las siguientes condiciones:

- 1 El dispositivo no debe causar interferencias nocivas.
- 2 El dispositivo debe admitir cualquier interferencia recibida, incluidas aquellas que pudieran provocar un funcionamiento incorrecto del mismo.



MSIP-REM-BMD-201410001
MSIP-REM-BMD-20150327
MSIP-REM-BMD-201702004
MSIP-REM-BMD-201702005

Declaración ISED (Canadá)

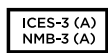

Este dispositivo cumple con las normas del gobierno de Canadá relativas a equipos digitales clase A.

Cualquier modificación o uso indebido del mismo podría acarrear un incumplimiento de dichas normas.

Las conexiones a interfaces HDMI deberán realizarse mediante cables blindados.

HDMI cables.

Este equipo cumple con las normas descritas anteriormente al emplearse en entornos comerciales. If the equipment is used in a domestic environment,

Nótese que podría ocasionar interferencia radial al utilizarlo en ambientes domésticos.

Seguridad

Para evitar el riesgo de descarga eléctrica, este equipo debe enchufarse a una toma de corriente que disponga de un cable a tierra. Ante cualquier duda, póngase en contacto con un electricista capacitado.

A fin de reducir el riesgo de descarga eléctrica, evite exponer el equipo a goteras o salpicaduras.

Este equipo puede utilizarse en climas tropicales, a una temperatura ambiente máxima de 40 °C.

Compruebe que haya suficiente ventilación en torno a la unidad.

Al instalar el equipo en un bastidor, verifique que el dispositivo contiguo no impida la ventilación.

La reparación de los componentes internos del equipo no debe ser llevada a cabo por el usuario. Comuníquese con nuestro centro de atención más cercano para obtener información al respecto.

service center.

Algunos productos pueden conectarse fácilmente a un transceptor óptico SFP. En tal sentido, conviene subrayar que solo es compatible con módulos láser clase 1.

Blackmagic Design recomienda los siguientes modelos:

- **SDI 3G:** PL-4F20-311C
- **SDI 6G:** PL-8F10-311C
- **SDI 12G:** PL-TG10-311C



Evite utilizar el equipo a una altura mayor de 2000 metros.

Declaración del Estado de California

Las partes plásticas de este producto pueden contener trazas de compuestos químicos, tales como polibromobifenilos (PBB), que el Estado de California reconoce como causantes de cáncer, anomalías congénitas o daños reproductivos.

Consulte la página www.P65Warnings.ca.gov para obtener más información al respecto.

Garantía

12 meses de garantía limitada

Blackmagic Design garantiza que el producto adquirido no presentará defectos en los materiales o en su fabricación por un período de 12 meses a partir de la fecha de compra. Si un producto resulta defectuoso durante el período de validez de la garantía, Blackmagic Design podrá optar por reemplazarlo o repararlo sin cargo alguno por concepto de piezas y/o mano de obra.

Para acceder al servicio proporcionado de acuerdo con los términos de esta garantía, el Cliente deberá dar aviso del defecto a Blackmagic Design antes del vencimiento del período de garantía y encargarse de los arreglos necesarios para la prestación del mismo. El Cliente será responsable del empaque y el envío del producto defectuoso al centro de servicio técnico designado por Blackmagic Design, y deberá abonar las tarifas postales por adelantado. El Cliente será responsable de todos los gastos de envío, seguros, aranceles, impuestos y cualquier otro importe que surja con relación a la devolución de productos por cualquier motivo.

Esta garantía carecerá de validez ante defectos o daños causados por un uso indebido del producto, o por falta de cuidado y mantenimiento. Blackmagic Design no tendrá obligación de prestar el servicio estipulado en esta garantía para (a) reparar daños provocados por intentos de personal ajeno a Blackmagic Design de instalar el producto, repararlo o realizar un mantenimiento del mismo; (b) reparar daños resultantes del uso de equipos incompatibles o conexiones a los mismos; (c) reparar cualquier daño o mal funcionamiento provocado por el uso de piezas o repuestos no suministrados por Blackmagic Design; o (d) brindar servicio técnico a un producto que haya sido modificado o integrado con otros productos, cuando dicha modificación o integración tenga como resultado un aumento de la dificultad o el tiempo necesario para reparar el producto. ESTA GARANTÍA OFRECIDA POR BLACKMAGIC DESIGN REEMPLAZA CUALQUIER OTRA GARANTÍA, EXPRESA O IMPLÍCITA. POR MEDIO DE LA PRESENTE, BLACKMAGIC DESIGN Y SUS DISTRIBUIDORES RECHAZAN CUALQUIER GARANTÍA IMPLÍCITA DE COMERCIALIZACIÓN O IDONEIDAD PARA UN PROPÓSITO PARTICULAR. LA RESPONSABILIDAD DE BLACKMAGIC DESIGN EN CUANTO A LA REPARACIÓN O SUSTITUCIÓN DE PRODUCTOS DEFECTUOSOS CONSTITUYE UNA COMPENSACIÓN COMPLETA Y EXCLUSIVA PROPORCIONADA AL CLIENTE POR CUALQUIER DAÑO INDIRECTO, ESPECIAL, FORTUITO O EMERGENTE, AL MARGEN DE QUE BLACKMAGIC DESIGN O SUS DISTRIBUIDORES HAYAN SIDO ADVERTIDOS CON ANTERIORIDAD SOBRE LA POSIBILIDAD DE TALES DAÑOS. BLACKMAGIC DESIGN NO SE HACE RESPONSABLE POR EL USO ILEGAL DE EQUIPOS POR PARTE DEL CLIENTE. BLACKMAGIC DESIGN NO SE HACE RESPONSABLE POR DAÑOS CAUSADOS POR EL USO DE ESTE PRODUCTO. EL USUARIO UTILIZA EL PRODUCTO BAJO SU PROPIA RESPONSABILIDAD.

© Copyright 2020 Blackmagic Design. Todos los derechos reservados. Blackmagic Design, DeckLink, HDLink, Videohub Workgroup, Multibridge Pro, Multibridge Extreme, Intensity y «Leading the creative video revolution» son marcas registradas en Estados Unidos y otros países. Todos los demás nombres de compañías y productos pueden ser marcas comerciales de las respectivas empresas a las que estén asociados.



安装操作手册

SmartView和 SmartScope

2020年9月

中文



欢迎辞

我们的梦想是希望人人都能拥有最优质的视频设备,从而使电视业成为真正充满创意的行业。

视频监看是一件不可缺少的设备。SmartView 4K配有原生4K LCD屏幕,让您能以全分辨率监看Ultra HD视频。此外,它的6RU精致机身还配备控制面板,能让您快速更改各项设置。SmartView HD配备一块17英寸的LCD大屏幕,以及厚度不到一英寸的6RU机身。SmartView Duo则配备两个完全独立的8英寸LCD屏幕,其3RU机身厚度也不到一英寸。SmartScope Duo 4K则拥有两块独立的8英寸LCD屏幕,可进行波形监看,让您能在繁忙工作时监看视频各项指标。所有SmartView监视器都配备3G-SDI接口,并支持SD、HD,以及2K视频。SmartScope Duo 4K和SmartView 4K还分别配备6G-SDI和12G-SDI接口,因此还能支持Ultra HD 4K影像!

视频监看设备的设计十分简洁,开箱即可投入使用。我们的Blackmagic SmartView Setup软件也可为用户们提供简单直观的配置工具。

本操作手册应涵盖您安装SmartView或SmartScope所需的一切信息。如果不明确IP地址或不熟悉计算机网络设置,请向技术人员咨询相关事宜。SmartView和SmartScope安装步骤简单,安装完成后您只需设置几项技术偏好即可。

完成安装大约需要5分钟。请登录我公司网站www.blackmagicdesign.com/cn,点击支持页面下载SmartView软件以及本手册最新升级资料。最后,请您在下载软件更新时完成设备注册,以便我们在发布新软件时能第一时间通知您。我们不断致力于产品的功能开发和改进,因此我们热忱期待您的意见和建议!

A stylized, handwritten signature in black ink that reads "Grant Petty".

Grant Petty

Blackmagic Design首席执行官

目录

SmartView和SmartScope

入门	205
SmartView和SmartScope产品简介	205
连接视频源	206
连接到计算机	206
安装Blackmagic SmartView Setup	207
使用Blackmagic SmartView Setup	208
软件更新	208
调整监视器设置	208
启用Tally边框	211
使用SmartView 4K	211
Blackmagic SmartView 4K简介	211
控制面板按钮	212
使用Blackmagic SmartView Setup加载3D LUT	214
使用SmartScope Duo 4K	215
什么是Blackmagic SmartScope?	215
视频监看显示	216
波形显示	217
矢量示波器	218
分量示波器	219
直方图显示	221
音频表显示	222
连接到网络	223
直接连接以太网	223
以太网交换机	223
调整网络设置	225
网络设置	225
添加一台Blackmagic监视器	227
使用Tally	228
Tally端口引脚连接	228
调整最佳监看角度	229
Developer Information	231
Blackmagic 2K Format — Overview	231
Blackmagic 2K Format — Vertical Timing Reference	232
Blackmagic 2K Format — Data Stream Format	233
Blackmagic SmartView Ethernet Protocol v1.3	234
帮助	238
监管声明	239
安全信息	240
保修	241

入门

SmartView和SmartScope产品简介

SmartView监视器可完美纳入各类机架式监看设备中。只需通过简单步骤连接电源和SDI视频源便可开始监看工作!

SmartView 4K配有一块15.6英寸4K LCD显示屏,能以原生3840x2160像素分辨率监看SD、HD或Ultra HD视频。此外,它还设有前面板控制按钮,能轻松选择输入,调节屏幕亮度、检查蓝色通道噪点,查看消隐信息,以及应用3D LUT等多项功能。

SmartView HD配有一块17英寸LCD显示屏,能以全分辨率提供精准的HD监看。

SmartView Duo配有两块监视屏,可同时显示不同视频信号。例如,一块显示屏可显示YUV 4:2:2信号,而另一块则可接收RGB 4:4:4信号。或者一块显示NTSC制式,另一块显示PAL制式。各款设备可有各种不同组合,但都只需要单根SDI线缆分别连接各监视器即可!

SmartScope Duo 4K和SmartView Duo功能一样,但是前者还可实时显示波形、矢量图及其他常见波形,用于监测视音频的各项指标。此外,它还全面支持Ultra HD 4K!

SmartView和SmartScope监视器上的所有SDI输入接口都支持自动检测SD、HD或3G-SDI,包括2K视频。SmartView 4K还可检测包括通过12G-SDI输入的2160p60等Ultra HD信号。SmartScope Duo 4K则可通过其6G-SDI接口自动检测Ultra HD 4K视频。

如果需要从计算机远程调整多台SmartView和SmartScope的各项设置,只需将设备连接到以太网即可。这意味着您无需亲自带着电脑和USB连接线反复去到机房将它们逐个进行调整了。

准备完毕后便可开始工作了! 有关如何连接SmartView和SmartScope、如何通过Blackmagic SmartView Setup软件配置监视器设置以及如何连接网络的具体信息,请继续阅读接下来的章节。



SmartView 4K



SmartView HD



SmartView Duo



SmartScope Duo 4K

连接视频源

SmartView和SmartScope监视器都配有BNC接口，可连接的SDI设备包括各类切换台、摄影机、采集卡、录机以及硬盘录机等。

获取画面

显示视频非常简单，只需开启设备，并将视频源连接到SDI输入接口即可。开启并连接到设备后，视频应可立即显示。SDI输入和环通输出接口可自动检测SD、HD以及2K信号。SmartView 4K和SmartScope Duo 4K还可检测Ultra HD 4K信号。

当设备未接收到任何视频信号时，背光灯会关闭以节省电源，等接收到下一个信号时再次亮起。

菊链式连接监视器

每台SmartView和SmartScope监视器都具备其独立的SDI输入及环通输出，以便您通过菊链式将多台监视器连接在一起，显示相同输入信号：

- 1 开启1号设备。将视频源连接到SDI输入接口。视频应立即显示。
- 2 开启2号设备。用SDI连接线从1号设备的环通输出接口连接到2号设备的SDI输入接口。

连接的设备数量并无限制。

使用SmartScope Duo 4K监看波形时，您可能需要将1号监视器环通输出到2号监视器，以便两台显示器都可以使用同一个输入信号。

视频显示后，您可以调整监视器设置，或使用Blackmagic SmartView Setup软件选择需要在SmartScope Duo 4K上显示的波形，该软件还可将3D LUT加载到Blackmagic SmartView 4K上。



连接到计算机

通过USB连接到您的计算机并安装Blackmagic SmartView Setup软件后即可为SmartView或SmartScope监视器配置各项设置。

USB接口还可用于执行内部软件更新（软件可从Blackmagic Design网站下载）。软件更新后可获得更多新增功能、更大的硬件兼容力和更多格式支持。Blackmagic SmartView Setup软件支持macOS和Windows计算机。

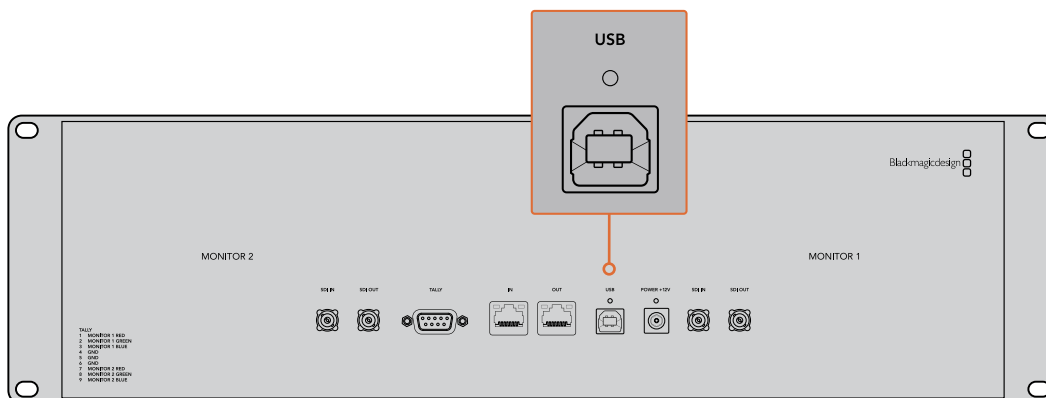

安装Blackmagic SmartView Setup

Blackmagic SmartView Setup可在最新的Sierra和High Sierra版本macOS, 以及安装了最新升级服务包的64位版本Windows 8.1和10系统上运行。如有需要, Blackmagic SmartView Setup可安装在多台联网计算机上。

SmartView自带附有安装程序的SD卡, 同时, 我们仍推荐您访问公司网站 www.blackmagicdesign.com/cn/support 以确保您安装的是最新版本。

在macOS系统下安装:

打开自带的SD卡后者下载的磁盘图像, 然后双击安装SmartView图标。系统会在您的“应用程序”文件夹下创建一个名为“Smartview”的文件夹, 当中含有SmartView Setup软件, 一个卸载程序 (更新时用于移除旧版本), 以及一个含有本操作手册以及SmartView其他信息的文档文件夹。

在Windows系统下安装:

在Windows系统下, 打开内附SD卡或点击下载后的压缩文件, 然后双击SmartView安装程序。请根据屏幕提示完成软件安装。

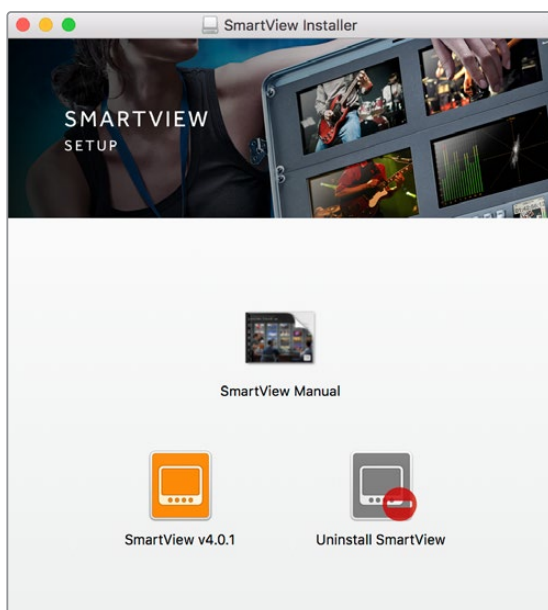

如果在macOS系统下安装, 请运行内附SD卡或下载文件夹中的 SmartView.dmg文件, 然后双击SmartView安装图标

使用Blackmagic SmartView Setup

软件更新

安装并运行Blackmagic SmartView Setup后, 点击监视器名称下方的设置图标。该软件可能会提示您更新SmartView或SmartScope的内部软件。具体操作步骤如下:

- 1 通过USB接口或以太网将SmartView或SmartScope和计算机连接, 然后运行Blackmagic SmartView Setup。
- 2 弹出对话框之后, 点击“Update” (更新)。更新过程可能需要5分钟左右。
- 3 更新完成后会弹出“**This SmartView has been updated**” (SmartView已完成更新) 消息, 提示您更新已完成。
- 4 点击“Close” (关闭)。

如果无需升级内部软件, Blackmagic SmartView Setup会打开监视器设置页面。

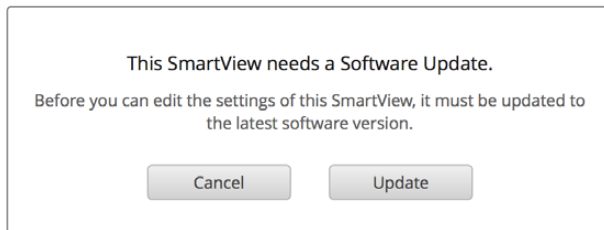

运行SmartViewSetup并打开所连接SmartView或SmartScope的设置图标时, 如果需要进行内部软件更新, 系统会弹出以上信息。

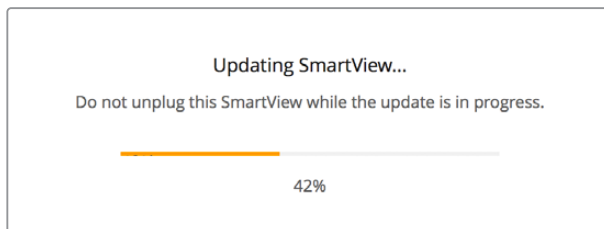

更新过程可能需要5分钟左右。

调整监视器设置

Blackmagic SmartView Setup打开时会立即搜索任何通过USB或者以太网连接的SmartView或SmartScope设备, 并在SmartView Setup软件主页上显示。如果您的网络中连接了多台Blackmagic监视器, 请点击主页两侧的左右箭头图标选择需要调整的监视器。如果您的Blackmagic监视器是通过USB连接, 那么监视器名称边上会显示一个USB图标。

调整设置时, 请选择通过以太网或USB连接的监视器, 然后点击监视器名称下方的设置图标。该操作将会打开您所选监视器的设置页面。设置妥善后, 请点击“Save”按钮来保存您的设置并回到SmartView Setup主页。

更多关于Blackmagic监视器的可用设置及其应用的内容, 请参考下文。更多关于使用Blackmagic SmartView Setup配置网络设置的内容, 请参考“调整网络设置”章节。

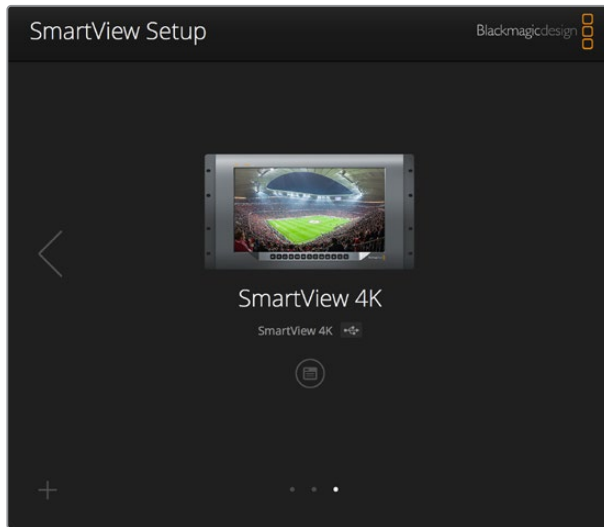

Blackmagic SmartView Setup会自动搜索通过USB或网络获得本地连接的SmartView和SmartScope设备。为您的监视器更新内部软件时, 请确保监视器通过USB或以太网连接。监视器名称一旁会出现USB图标。

监视屏设置

要为每台监视器调整设置和显示, 请务必通过以太网或USB连接设备。点击SmartView Setup主页左右两侧的箭头图标来选择您想要设置的监视器, 然后点击监视器名称下方的设置图标。设置页面将自动进行自定义调整, 以便与您所选Blackmagic监视器所支持的功能相配套。

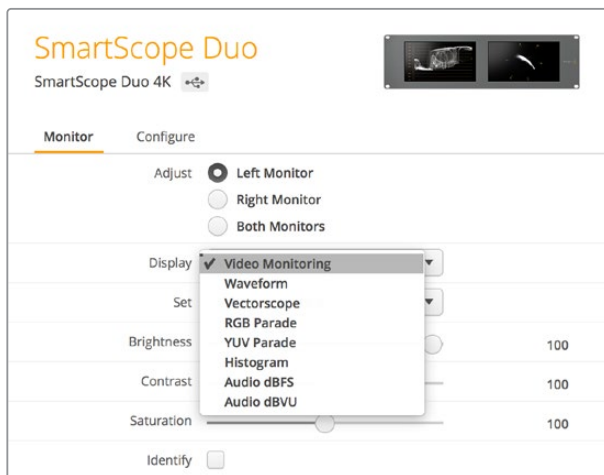

如使用SmartScope, 您可以选择不同波形以及从“Display” (显示) 下拉菜单中选择需要监看的视频。

Adjust (调整)

使用SmartScope或SmartView Duo时, 请根据情况勾选“Left Monitor” (左侧监视屏)、“Right Monitor” (右侧监视屏) 以及可进行同时调整的“Both Monitors” (两侧监视屏) 选项来选择想要调整的监视屏。启用“Both Monitors”设置之后, 所有针对亮度、对比度以及饱和度所应用的调整会对SmartView Duo和SmartScope监视器同时生效。

Display (显示)

使用SmartScope时, “Display” (显示) 下拉菜单可提供不同波形供您选择。如要监看视频画面, 请选择“Video Monitoring” (视频监看)。

Set (设置)

使用SmartScope监看标清视频时, “Set” (设置) 下拉菜单可用来选择4:3或16:9宽高比用于视频监看显示。“Set”下拉菜单可为选中显示器提供更多选项, 如矢量图、音频dBFS以及音频dBVU等。

- **Video Monitoring (视频监看)** : 视频画面监看可在4:3或16:9宽高比之间选择。
当监看宽屏变形标清视频时, 请选择16:9宽高比。当监看传统4:3标清视频时, 请选择4:3宽高比。
- **Vectorscope (矢量示波器)** : 请为您的输入选择100%或75%彩条测试信号。
- **Audio dBFS (音频dBFS)** : 选择一对音频通道来监看相位。
- **Audio dBVU (音频dBVU)** : 选择一对音频通道来监看相位。

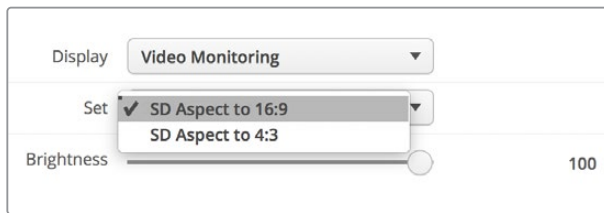

监看变形标清视频时, 请设置为“SD Aspect to 16:9”。

亮度、对比度以及饱和度

调节滑块可应用不同的Brightness (亮度)、Contrast (对比度) 及Saturation (饱和度) 设置。具体可用设置视SmartView和SmartScope型号而定。

识别监视器

启用“Identify” (识别) 复选框时, Blackmagic SmartView Setup中的所有选定监视器均会显示白色边框。通过网络连接多台SmartView和SmartScope设备时, 使用这一设置后所选监视器可一目了然。

如果使用这一设置的同时结合使用“Both Monitors” (两侧监视屏) 选项, 那么SmartView Duo或SmartScope Duo 4K的两块监视屏上会同时显示白色边框。

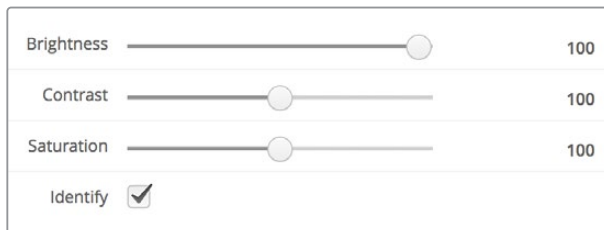

左右拖动滑块调节亮度、对比度以及饱和度设置。
检查“Identify” (识别) 设置, 以便清楚查看到您所选择的监视器。

启用Tally边框

勾选“Enable Tally Override”（启用Tally边框）选项可在Blackmagic SmartView 4K上启用Tally边框。该功能兼容Blackmagic URSA Mini Pro 4.6K和Blackmagic URSA Broadcast摄影机。

将摄影机的SDI输出连接到SmartView 4K的输入A或者输入B上。

将ATEM切换台的节目输出连接到摄影机的SDI输入上。

此时，当ATEM切换台将摄影机画面切换到节目输出时，SmartView 4K上就会出现红色Tally边框，当摄影机画面切换到预览输出时，Tally边框就会变成绿色。

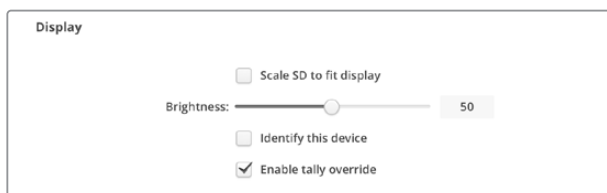

点击“Enable Tally Override”复选框后，当连接Blackmagic URSA Mini Pro或URSA Broadcast摄影机时，SmartView 4K会显示Tally边框

使用SmartView 4K

Blackmagic SmartView 4K简介

SmartView 4K是一款6RU大小的Ultra HD 12G-SDI广播级监视器，可显示SD和HD影像，并可查看高达2160p60的Ultra HD视频。这款监视器拥有明亮的显示屏和超宽可视角度，画面生动清晰，能为您带来准确对焦和色彩监看，并支持几乎任何视频格式。

SmartView 4K专为演播厅和户外播出环境设计，使用极其便捷。它的两侧设有众多接口，并支持VESA安装标准，可安装在狭小空间，或固定于墙面以及显示器支架上。SmartView 4K可通过其内置的控制面板进行操作，当您无法触及前面板时，它也可通过以太网实现远程控制。

它设有两个多速率12G-SDI输入，可选择两个SDI信号源；一个SMPTE兼容SFP模块槽，可用于添加光纤SDI模块从而通过光纤连接视频；一路12G-SDI输出，以便将视频信号连接到其他设备上；两个以太网接口，用于网络连接、远程控制以及和其他监视器通过菊链式连接在一起实现环通输出。其他接口还包括用于现场制作的Tally输入接口，以及用于内部软件更新的USB端口。

您甚至可以使用Blackmagic SmartView Setup软件来加载带有.cube扩展名的行业标准3D LUT或DaVinci Resolve生成的LUT！有了3D LUT，您就可以将您的SmartView 4K直接连接到摄影机上，以尽可能接近调色成品的画面查看拍摄片段。SmartView 4K拥有两个级别的峰值对焦设置，可确保您的拍摄镜头完美对焦。此外，它同时支持AC和DC电源，可提供不同电源连接选择，让您直接连接主电源，或连接外部电池，在工作现场获得便携方案。

SmartView 4K是便携式以及演播室播出制作的完美监看方案,能以原生3840x2160像素分辨率显示SD、HDI以及Ultra HD视频。



备注: 如果通过DC电源输入连接了外部电源,请确保您的外部电源输出可提供24瓦12伏电源。

控制面板按钮

SmartView 4K的控制面板配有一排按钮,可快速调整监视器的设置。

Input (输入)

按此按钮可逐个浏览所有连接到SmartView 4K两路12G-SDI输入接口以及选配光纤SFP模块输入接口上的视频信号。如果某路输入接口上未连接任何视频, SmartView 4K将为该路输入显示为黑屏。在各路输入间切换时,所连接的输入信号格式信息将短暂显示在监视屏左上角。

DISP (显示)

“DISP”按钮可用来调整SmartView 4K监视器LCD屏幕的亮度设置。按向上和向下箭头按钮可调整亮度。再次按下“DISP”按钮可关闭该设置。

H/V DELAY (水平/垂直延迟)

按下“H/V DELAY”按钮可快速确认您的SDI视频信号中嵌入的辅助数据。举例说明,按“H/V DELAY”按钮一次可查看水平辅助数据。再次按下“H/V DELAY”按钮可查看垂直辅助数据,该数据常用于隐藏式字幕等数据。

BLUE ONLY (纯蓝模式)

如果数字视频信号中出现噪点,蓝色通道可显著体现出这一信息。您可以按下“BLUE ONLY”按钮通过蓝色通道来轻松检查噪点情况。这一模式可仅显示纯蓝通道,并以黑白图像的形式表现。这一黑白图像还可在检查摄影机对焦时起到辅助作用。

ZOOM (缩放)

使用“ZOOM”按钮可令摄影机获得清晰对焦。按此按钮一次可放大图像，以便清晰查看拍摄主体是否精准对焦。再次按下该按钮可回到正常查看大小。

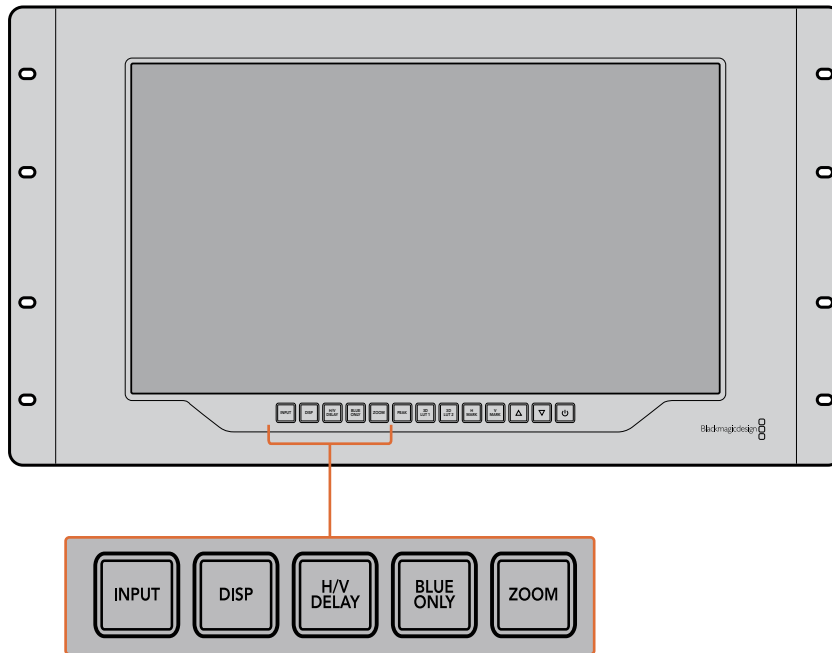

PEAK (峰值)

按“PEAK”按钮可启用峰值对焦功能，轻松检查摄影机对焦。该功能可在画面中锐度最高的部分显示明亮的绿色边缘。峰值对焦强度共有两个级别，您可以连续按下“PEAK”按钮加以切换。当绿色边缘采用最强级别时，您可以确保摄影机对焦。

3D LUT 1和3D LUT 2

这两个LUT按钮可使用Blackmagic DaVinci Resolve生成的自定义3D LUT或者行业标准.cube LUT查看画面。按其中一个LUT按钮一次可启用该LUT。再次按下该按钮可禁用该LUT。更多关于如何在SmartView 4K上使用3D LUT的信息，请查阅“使用Blackmagic SmartView Setup加载3D LUT”部分的内容。

H MARK (水平标记线) 和V MARK (垂直标记线)

您可以使用“H MARK”和“V MARK”按钮来查看并编辑帧导栏。帧导栏能帮助您进行镜头取景和构图，还能将重要信息或图文保持在屏幕安全区。由于不同型号的电视机会显示更多或更少的视频信号边缘，因此查看安全区是一项非常有用的功能。安全区指的是不论使用何种型号的电视机或监视器，其屏幕中都能始终查看到的画面区域。

要查看水平和垂直帧导栏，可分别按“H MARK”和“V MARK”按钮。要编辑帧导栏，请再次按下相应的按钮使该帧导栏高亮显示即可。这样您就能使用上下箭头来编辑每个帧导栏标记的位置了。连续按下每个相应按钮将确认您编辑的新位置。再次按下相应按钮可关闭帧导栏标记。

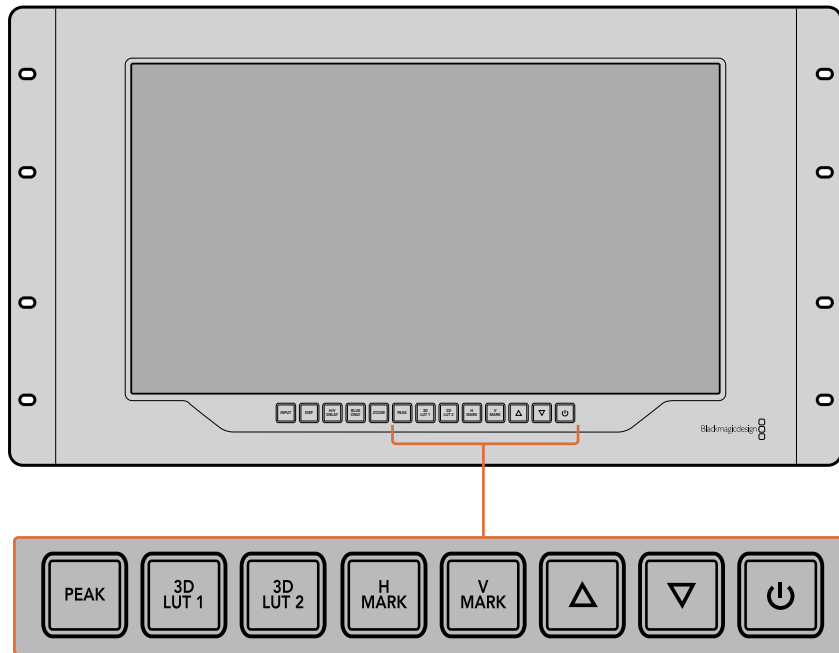

上下箭头按钮

当您编辑某项设置，例如调整显示器亮度或编辑帧导栏位置时，可使用上下箭头按钮。

功耗

按电源按钮一次可开启SmartView 4K。再次按下可关闭设备。

使用Blackmagic SmartView Setup加载3D LUT

SmartView 4K可使用3D LUT来监看您的视频。这样能便于您使用专业的校准LUT来校准您的SmartView 4K，或者以尽可能接近最终调色成品的画面来查看您的视频。您还能使用3D LUT来尝试不同画面风格。LUT可通过Blackmagic SmartView Setup软件加载到SmartView 4K上。此外，由于SmartView 4K支持以.cube作为文件扩展名的行业标准LUT文件，您甚至还能加载由Blackmagic DaVinci Resolve生成的自定义LUT。更多关于生成LUT文件的信息，请查阅DaVinci Resolve操作手册。

将一个3D LUT加载到3D LUT 1:

- 1 运行Blackmagic SmartView Setup。
- 2 按“Load LUT 1”加载按钮。系统将弹出窗口询问您想要加载的LUT文件的位置。选择相应的.cube LUT文件，然后按“Open”（打开）按钮。
- 3 要查看您刚才加载的LUT，可按SmartView 4K控制面板上的“3D LUT 1”按钮。再次按下该按钮可关闭相应LUT。

请使用相同步骤将一个LUT文件加载到3D LUT 2中。

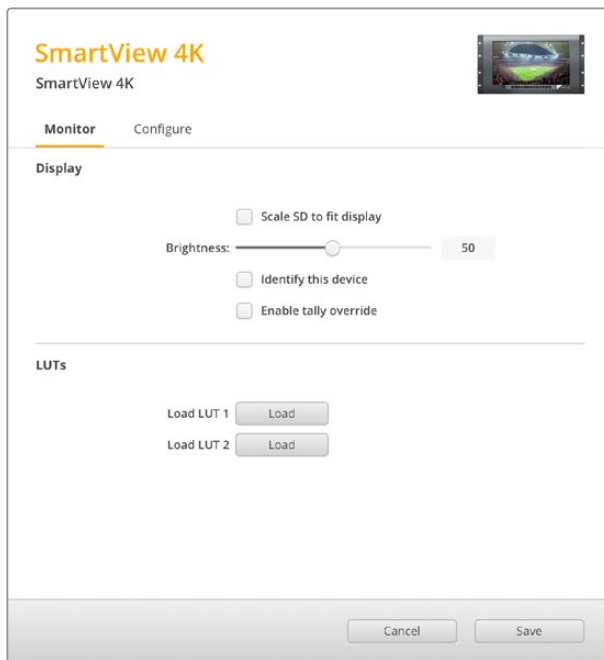

使用Blackmagic SmartView Setup在SmartView 4K上加载3D LUT

使用SmartScope Duo 4K

什么是Blackmagic SmartScope?

以前，广播级电视机和后期制作示波器都是非常昂贵的自定义方案，而且它们一次只能监看一种波形，屏幕也十分狭小。有些示波器外形欠佳，无法向客户展示。

有了SmartScope Duo 4K，您可以再获得额外的波形监视器，通过两块监视屏实时监看视频信号的各类指标。您在Blackmagic SmartView Setup中对输入信号所做的任何调整都能立即通过SmartScope Duo 4K查看到。此外，每路输入信号都可经由SDI环通输出到任意一个监视屏上，也就是说，您可以使用左边的监视屏接收信号，使用右边的监视屏显示该信号的波形。

SmartScope Duo 4K所显示的波形可通过Blackmagic SmartView Setup软件选择。从“Display”（显示）下拉菜单中选择需要监看的波形。

接下来的几页中，本手册会向您介绍各类波形的含义及用途，以便您进一步了解并对其加以充分利用。

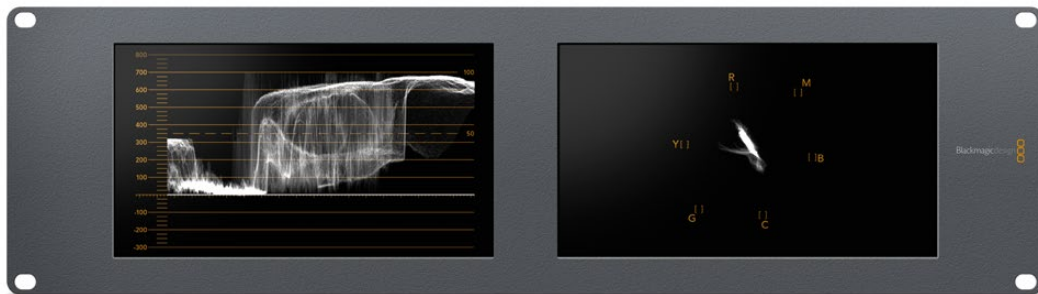

使用Blackmagic SmartView Setup软件可简单地将您的Blackmagic SmartScope Duo 4K设置成在每块显示屏上显示不同波形。

视频监看显示

Video Monitoring (视频监看) 显示具有准确和便捷的特点, 您可以监看到SmartScope接收到的视频。

如果输入信号是SD, 那么在“Set” (设置) 下拉菜单中有“4:3 Pillarbox”或“16:9”两种显示模式可以选择。您对LCD屏幕的“Brightness” (亮度)、“Contrast” (对比度) 或“Saturation” (饱和度) 所做的任何更改都会立即体现在画面上。请注意, 这些设置改动只对监视屏有效, 并不会影响视频信号。因此各类波形也不会因为改变了饱和度或亮度等而受到影响。

您还能将其中一个监视屏设置成“Video Monitoring” (视频监看), 而另一个监视屏用于监看波形。要进行这一操作, 请使用一根短连接线将“MONITOR 1”这一侧的SDI OUT环通输出口连接“MONITOR 2”这一侧的SDI IN输入接口。

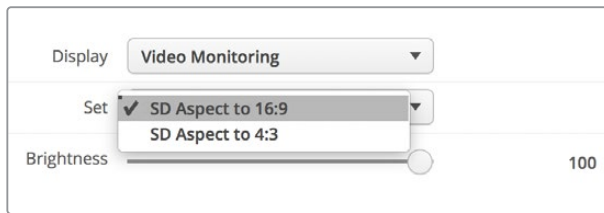

您可以在Blackmagic SmartView Setup软件的“Set”选项中进行选择, 从而以4:3左右加黑边或16:9宽屏模式来查看SD视频。监看变形标清视频时, 请设置为“SD Aspect to 16:9”。



“Video Monitoring” (视频监看) 显示设置能呈现电视机或监视器屏幕所显示的视频信号。

波形显示

“Waveform”（波形）显示可提供和传统亮度波形监视器类似的数字编码波形，可用于监看和调整视频信号的亮度电平指标。

传统的亮度波形监视器只支持复合模拟标清视频。但是，SmartScope Duo 4K显示的波形视图支持Ultra HD、HD和SD，因此即使您在监看高清数字视频格式时也可以轻松调整亮度电平从而确保一致。

从Blackmagic SmartView Setup软件的“Display”（显示）下拉菜单中选择波形。请务必确保波形中的黑色部分不低于0%，白色部分不高于100%，否则会存在非法亮度值。

波形监视器可将画面信息以图形的方式呈现出来，显示画面中相同位置所对应的亮度值。举例说明，如果图像中的天空部分出现过曝现象，那么波形图中的相同水平位置会相应体现出来。

不同的视频素材，其波形显示各有不同。如果您监看的视频具有高对比度，那么波形图中可能不会显示任何中灰色数值。下图所示的是曝光均匀的图像波形，该图左侧有一小块黑色区域，而较为明亮的部分则分布在画面中部到右部。

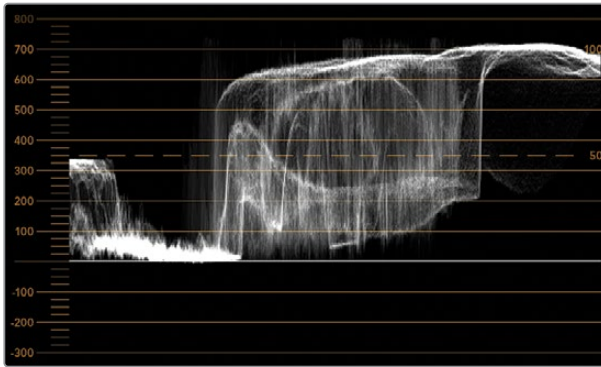

波形视图可反映出亮度值

Adjust	<input checked="" type="radio"/> Left Monitor
	<input type="radio"/> Right Monitor
	<input type="radio"/> Both Monitors
Display	Waveform ▼
Set	No Options ▼

在Blackmagic SmartView Setup的“Display”（显示）设置中选择“Waveform”（波形）选项来查看您视频信号中的亮度值信息。

矢量示波器

“Vectorscope”（矢量）示波器以矢量视图方式体现视频信号中的不同颜色。请根据设备所使用的彩条测试信号标准，从Blackmagic SmartView Setup的“Set”（设置）下拉菜单中相应选择100%或75%。

有些使用者认为矢量示波器可用来检查非法电平，这一认识是错误的。非法色彩需使用分量RGB波形显示才能检查。因为您需要同时有色度和亮度两种信息才能检查非法电平，所以矢量示波器并不适用。例如，视频中接近黑场和白色的颜色饱和度没有浓艳的色彩饱和度高，这些色彩可在中性灰中使用。由于Vectorscope（矢量示波器）只显示颜色，并非亮度数值，因此无法用于专门检查非法色彩。

矢量示波器显示最适合用来检查老式模拟录像带中的色彩电平，以帮助您调整色度电平。请先播放录像带中彩条的部分，然后调整色度和色相设置，将视频的各个色彩限定在刻度线内的方格中。

此外，矢量示波器还十分适合进行调色时使用，因为它能直观地告诉您视频的白平衡设置是否正确，以及是否出现偏色。如果视频存在偏色现象，矢量示波器显示会从中间向外偏移，您可能会见到两个中心点。通常情况下，消隐的视频信号会在矢量示波器中心形成一个点，这是因为消隐的视频是不带任何色彩黑场视频。消隐可提供十分有用的参照点，有助于识别出无任何色彩信息的黑场视频区域。

如果您的视频存在偏色问题，就会发现矢量示波器中的暗部会偏离色彩并偏离中心。偏离的程度代表了视频中偏色的程度，您可以看到视频中亮部和暗部细节部分的偏离情况。因此Vectorscope（矢量示波器）显示能移除偏色并重新得到恰当的白平衡值。

矢量示波器能让您使视频中的颜色看起来尽可能艳丽，但不会不小心在暗部和亮部造成不必要的偏色。虽然色彩平衡可通过RGB分量显示以及矢量示波器显示监看，但是通常后者较易发现色彩平衡问题。

当为素材中的肤色部分，尤其是人物面部进行调色时，请尽量将矢量示波器中的暖色调饱和度线条与指向十点钟方向的轴线对齐。这条轴线俗称“Fleshtone Line”（肤色轴线），它是以皮肤表层下的血色为基准的。因此，肤色轴线可用于针对肤色瑕疵的校准，让演员的拥有自然肤色。

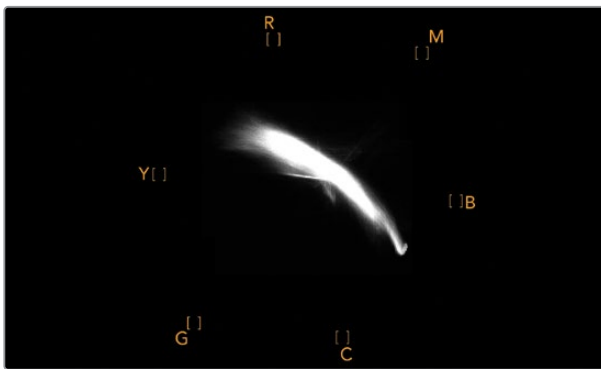

图中的矢量示波器显示出指向十点钟方向的“肤色轴线”。

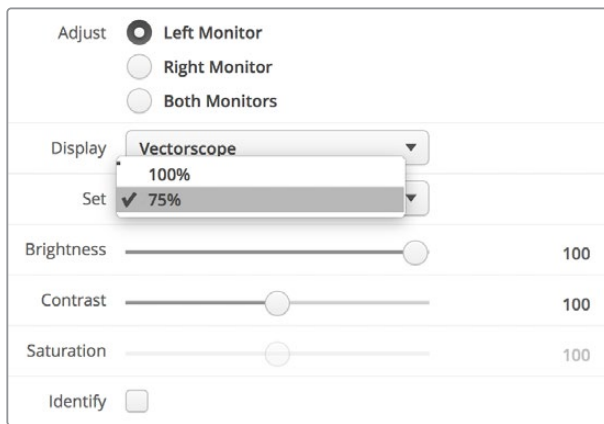

将“Vectorscope”（矢量示波器）设置为100%或75%彩条测试信号。

分量示波器

RGB和YUV分量显示十分适合调色、检查非法色彩以及检查电平时使用。

调色时，从Blackmagic SmartView Setup的“Display”（显示）下拉菜单中选择“RGB Parade”（RGB分量）。RGB Parade（RGB分量）视图将单独显示红、绿、蓝色彩通道的全高图。能对每个通道进行单独查看使得调色变得简单直接，而且也能更容易检查视频信号中暗部、中间调以及亮部的平衡。RGB Parade（RGB分量）能让您注意到红、绿、蓝色彩通道中常见的各个细节，从而更好地控制色彩平衡并移除偏色。

调色的时候有一点很重要，就是要确保视频的电平达到饱满但不出现限幅现象。如果您想要提高视频电平，请务必确保其不超过RGB限度，否则会产生非法电平。虽然有些设备不允许生成非法的100%RGB电平，但是还是有设备会依然允许生成非法电平的。SmartScope Duo 4K能在产生非法电平时予以即时反馈。

黑电平和白电平都有可能出现非法视频。有些调色系统可以把黑电平降低到0%黑场以下。如果发现非法黑电平，只需调高“Lift”或“Gain”即可消除非法黑电平，同时请检查100%刻度，以确保整体视频信号的亮部未超标并产生非法色彩。

若要检查YUV电平，请在“Display”（显示）下拉菜单中选择“YUV Parade”（YUV分量）。这一视图非常有用，因为它把Luma（亮度值）和Chroma（色度值）分开了，这正是电视播出机构视频信号的格式。左边的波形表示亮度信息，第二个和第三个波形显示色度信息。YUV分量视图很适合将视频信号的色度值和彩条测试图案进行校准，从而确保色彩准确性，以便让播出信号可以在电视机上显示。

调色是不断调整颜色达到最佳图像效果，并保证不出现非法电平的过程。

调色术语

暗部 — 视频信号中的黑电平

中间调 — 视频信号中的中灰电平

亮部 — 视频信号中的白电平

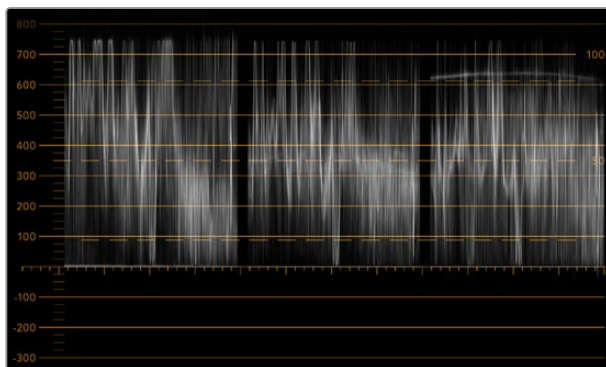

RGB分量视图

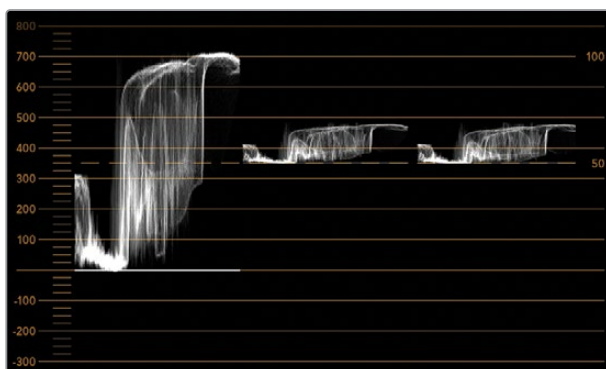

YUV分量视图

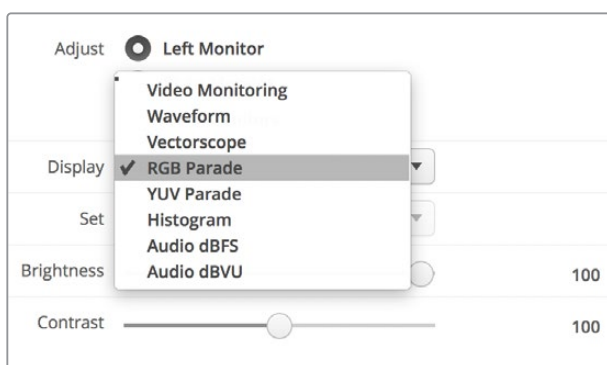

从Blackmagic SmartView Setup的“Display”（显示）下拉菜单中选择“RGB Parade”（RGB分量示波器）或“YUV Parade”（YUV分量示波器）。

直方图显示

“Histogram”（直方图）显示对于平面设计师以及摄影师来说并不陌生。直方图反映的是亮部和暗部信息的分布，让您能监看到视频中亮部和暗部细节接近被限幅的程度。直方图能让您直观地监测到视频中Gamma值的变化所产生的影响。

视频暗部显示在屏幕左侧，亮部显示在右侧。视频在直方图中的波形一般都介于0%到100%区间。视频的波形低于0%或超过100%的部分都会被限幅。拍摄时应尽量避免出现视频限幅，因为如果您之后需要进行较好的调色，那么画面中暗部和亮部的细节必须要同时保留。拍摄时，将视频波形控制在黑场裁切以上，白场裁切以下，这样才能在之后的调色环节获得最大限度的还原力，避免出现暗部和亮部模糊以及细节丢失的问题。

调色时，您可能需要对视频进行限幅，此时直方图可反映视频限幅后的效果及限幅的幅度。您甚至可使用Gamma曲线来达到类似效果，减少限幅的同时保留更多细节。

虽然直方图可用来观察暗部和亮部的非法信息，但是它不能用于监看非法电平。直方图并不显示颜色，因此即使您的视频中存在非法色彩，它也只显示合法电平。RGB Parade (RGB分量示波器) 才是最适合监看非法色彩电平的波形显示，因为它能反映视频信号中的色彩和亮度两种元素。

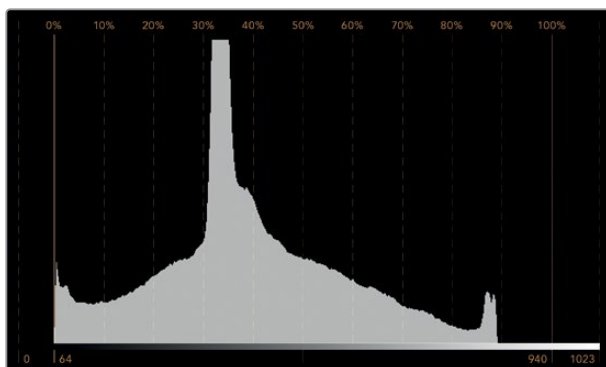

“Histogram”（直方图）设置可显示视频中亮部到暗部的信息分布。

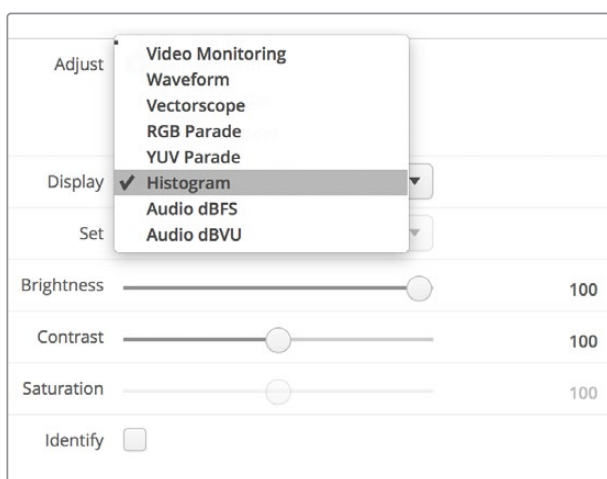

从Blackmagic SmartView Setup软件的“Display”（显示）下拉菜单中选择“Histogram”（直方图）显示。

音频表显示

“Audio”音频表显示可以告诉您SDI视频信号中嵌入音频的电平。共有多达16组嵌入式音频可被解嵌，并能以dBVU或dBFS格式显示。

VU表可显示平均信号电平，它使用方便，在老式设备中也较为常用。VU表依照SMPTE（电影电视工程师协会）建议的基准电平，将1kHz的声音测试信号校准为-20 dBFS。

dBFS是衡量数字音频信号整体情况的必要工具，它在如今的数字设备中十分常见。

右侧的音频示波器可监看两个声道，您可通过“Set”下拉菜单中选择例如1号和2号声道、3号和4号声道等。音频示波器使用X-Y轴视图来表示，这样您便能清楚查看音频平衡、异相情况以及音频轨道是单声道还是立体声等。单声道音频表现为一条垂直的“in phase”（同相）直线。如果该直线显示为横向，这就表示您的音频出现“out of phase”（异相），并有可能在发送到下游设备时出现音频抵消（即音频缺失）。音频相位问题在大型设备中经常出现，通常由错误连接线缆导致。

监测立体声信号时，右侧音频示波器线条会以扇形展开显示左右音频通道不同之处。音频轨道中含有的立体声越丰富，该线条的展开幅度就越趋向圆形。如果音频中包含的立体声内容为最小值，那么该示波器线条便会集中在纵坐标附近。

对话音频通常表现为一条竖线，而含有大量立体声的音乐音频会在音频表显示中呈现出扩张的形状。这是因为单声道音频是L+R，显示在纵坐标上，而立体声内容为L-R，显示在横坐标上，从而加以区分。

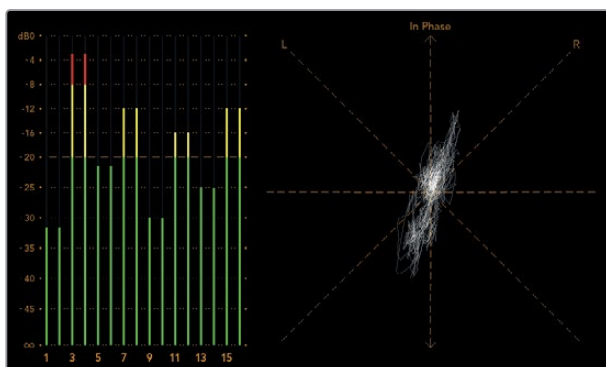

音频表显示的峰值电平和音频平衡。

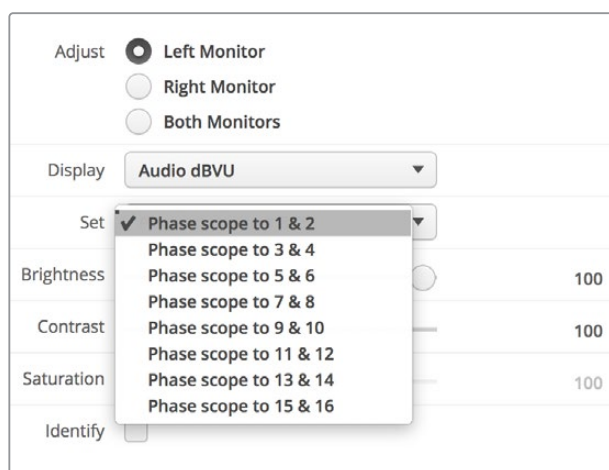

使用“Set”下拉菜单来选择需要监听的某一对音频通道。

连接到网络

将SmartView或SmartScope联网后, 您可以遥控调整多台设备的监视器设置。

SmartView和SmartScope的监视器无需配置即可显示视频, 但需要在部署之前调整好网络设置。网络设置只能通过USB接口连接计算机才能配置。

直接连接以太网

将计算机直接连接到以太网之后便可远程控制监视器配置。进行这一配置无需网络切换, 因此十分适合您进行快速安装和设置准备。如要连接更多设备, 只需将各设备环通输出Ethernet OUT (以太网输出接口) 以菊链式连接即可。请为联网的所有设备连接电源。

如果您想连接多台设备, 但是不想使用现成的工作室网络IP地址, 或者您没有现成的网络, 只需将它们直接连接到计算机上的以太网端口即可。这也是将SmartView和SmartScope设备连接到以太网的最快方法, 因为您不需要在网络交换机之间部署任何线缆。

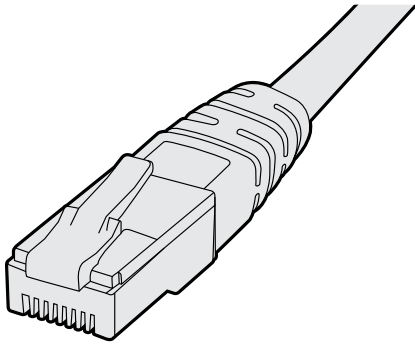

以太网接头

以太网交换机

如果您想要在工作室网络上连接多台设备, 那么只需将一台SmartView或SmartScope连接至网络交换机, 然后其余设备可通过开启的环通以太网输出端口相互菊链式连接, 这样只需占用交换机上的一个端口, 也无需在网络交换机上连接多条线缆了。请为所有设备连接电源, 以便菊链正常运行。

连接至网络交换机的方式可让您在网络上任意一台计算机上对设备设置进行更改。如果您的网络设有无线连接, 那么任意一台Mac或Windows笔记本电脑也都可通过WiFi无线网络来更改设置。

按照以下步骤可将SmartView或SmartScope连接至IP局域网:

- 1 确保设备连接电源并打开设备电源开关。
- 2 通过标准RJ45以太网连接线将设备连接至网络交换机, 或直接连至计算机。

直接连接以太网示意图

您可以无需经由网络交换机, 直接将设备连接至计算机的以太网端口。其余设备可通过菊链式相连, 因此无需在交换机上连接多条线缆。请务必为所有设备连接电源。

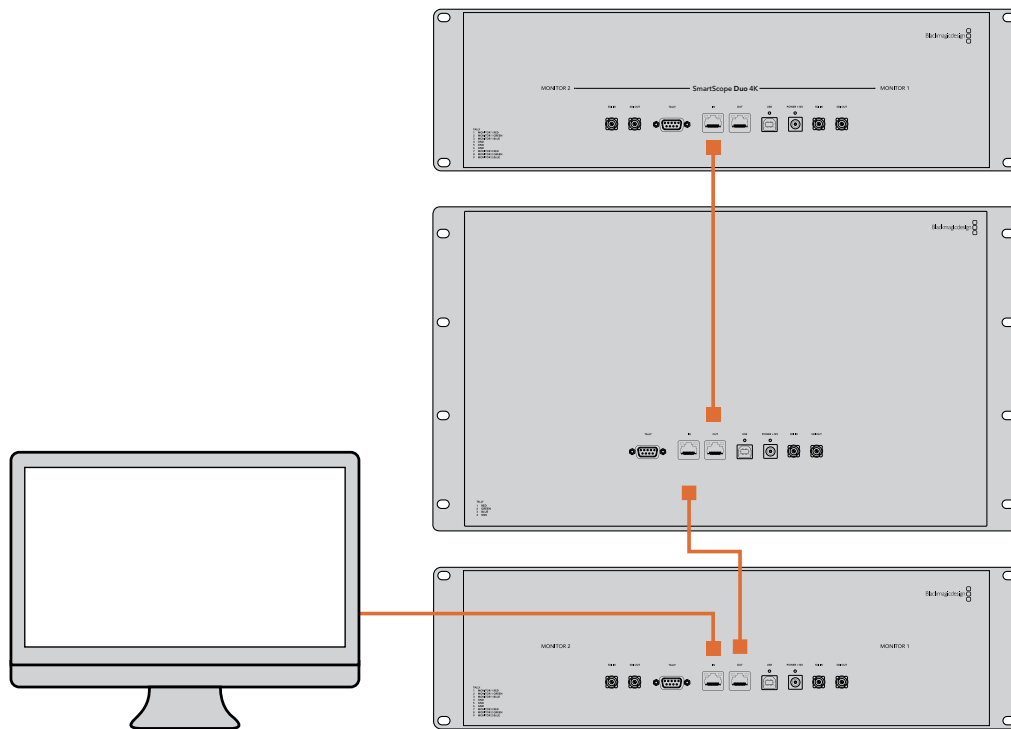

以太网交换机连接示意图

如果您想要将多台设备连接到现有的工作室网络中, 仅需要将一台设备连接到网络交换机即可。其余设备可通过菊链式相连, 因此无需在交换机上连接多条线缆。请务必为所有设备连接电源。

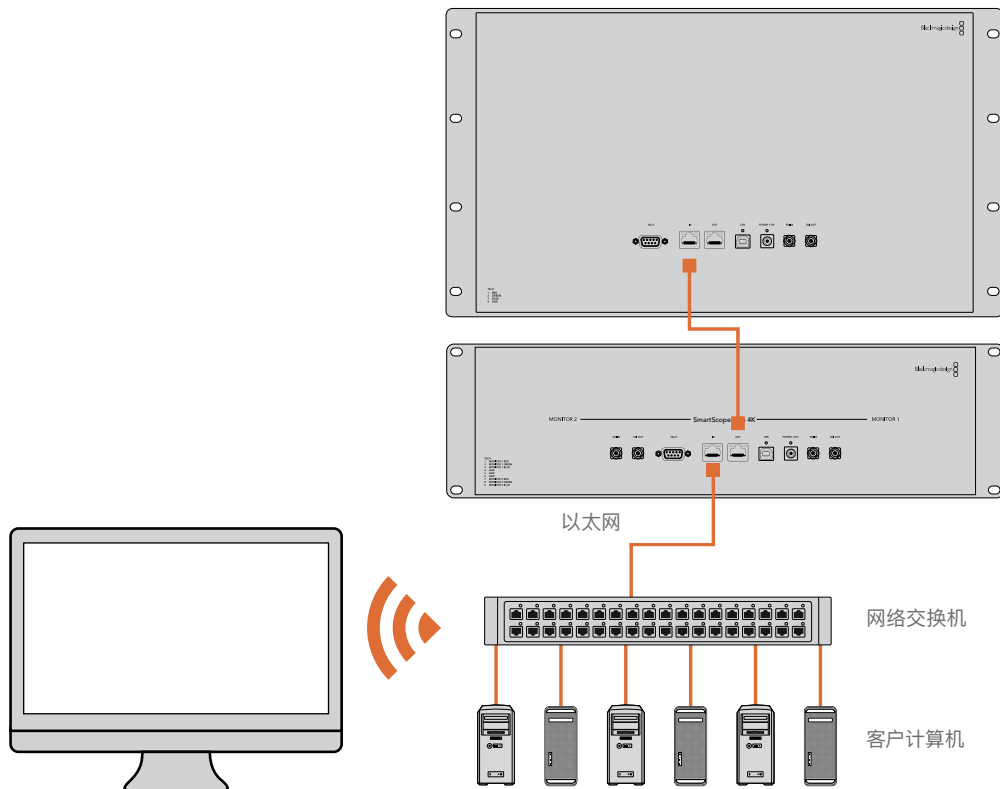

调整网络设置

网络设置

设备名称

建议您为监视器更改名称，这样能便于区分网络中的各台SmartView或SmartScope，例如：“现场摄影机1和2”、“Multi-View输出”、“4K信号”等等。

请确保监视器已通过以太网或USB连接，这样才能更改监视器名称。运行Blackmagic SmartView Setup软件，并点击监视器名称下方的设置图标。在设置页面中，点击“Network Settings”（网络设置），在“Details”（详细信息）部分编辑您的监视器名称。若软件检测到名称无效，您正在输入的名称旁边将出现警告图标。若名称有效，将出现一个绿色的勾。在您的计算机键盘上按回车键以确定名称更改。

网络设置

您的Blackmagic监视器必须通过USB连接至计算机，才能在Blackmagic SmartView Setup中更改网络设置。网络设置不能通过以太网连接进行更改。

默认设置下，SmartView和SmartScope使用DHCP可自动从网络中获取IP地址。

没有DHCP服务器时，您可以开启macOS系统的“互联网共享”功能，或Windows 8.1或Windows 10系统的“Internet连接共享”（ICS）功能，从而为任意一台直接连接的设备提供DHCP地址。这样可以避免为每台设备手动指派静态IP地址的步骤。您甚至可以在计算机没有网络连接的情况下，使用此方法来为设备提供DHCP地址。请阅读macOS、Windows 8.1和10的帮助信息获取有关网络共享的详细信息。

如配置中无法使用DHCP，请使用“Static IP”（静态IP）配置其地址。请询问您的系统管理员获取一个空余IP地址，从而避免网络中的IP地址冲突。您需要为每台SmartView和SmartScope设定一个特有的IP地址，以及常用的子网掩码。除非您是有意将互联网路由器等设备连接至网络网关，否则无需更改“Gateway”（网关）栏中的默认值。

如果网络中无法找到SmartView或SmartScope监视器,可能是设备没有通过DHCP接收到IP地址,此时您需要为每个设备手动配置合适的网络设置,步骤如下:

- 1 通过USB将Blackmagic SmartView或SmartScope连接至您的计算机,运行Blackmagic SmartView Setup软件。
- 2 您所连接的监视器将自动显示在SmartView Setup软件主页中,其名称旁边将显示一个USB图标。
- 3 调整您的监视器网络设置。
- 4 为其余未通过DHCP接收到IP地址的所有设备重复以上步骤。

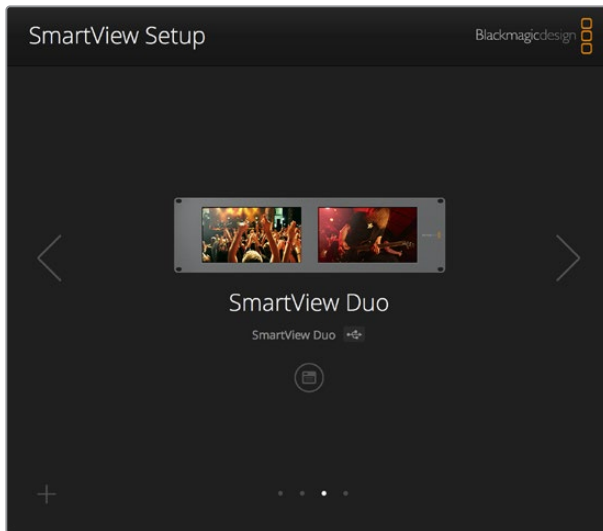

监视器名称旁边的USB图标代表了此监视器是通过USB连接至您的计算机。您的Blackmagic监视器需要通过USB连接才可调整网络设置。

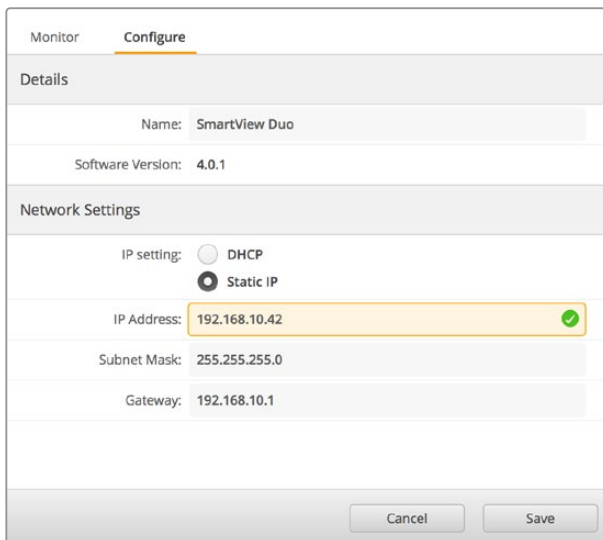

网络设置可使用DHCP或静态IP地址设置,且仅可通过USB连接进行更改。

添加一台Blackmagic监视器

如果您已知道SmartView或SmartScope Duo 4K的IP地址, 但该地址未能自动显示在Blackmagic SmartView Setup软件的主页时, 就需要手动添加监视器。具体操作步骤如下:

- 1 请确保您的Blackmagic监视器通过以太网连接。在左下角点击“+”图标, 打开“Add a Blackmagic Monitor” (添加Blackmagic监视器) 窗口。
- 2 键入监视器的IP地址并点击“Add” (添加)。
- 3 软件将验证添加设备, 并将其添加到SmartView Setup主页所包含的Blackmagic监视器中。点击向右箭头图标可看到您最新添加的监视器。

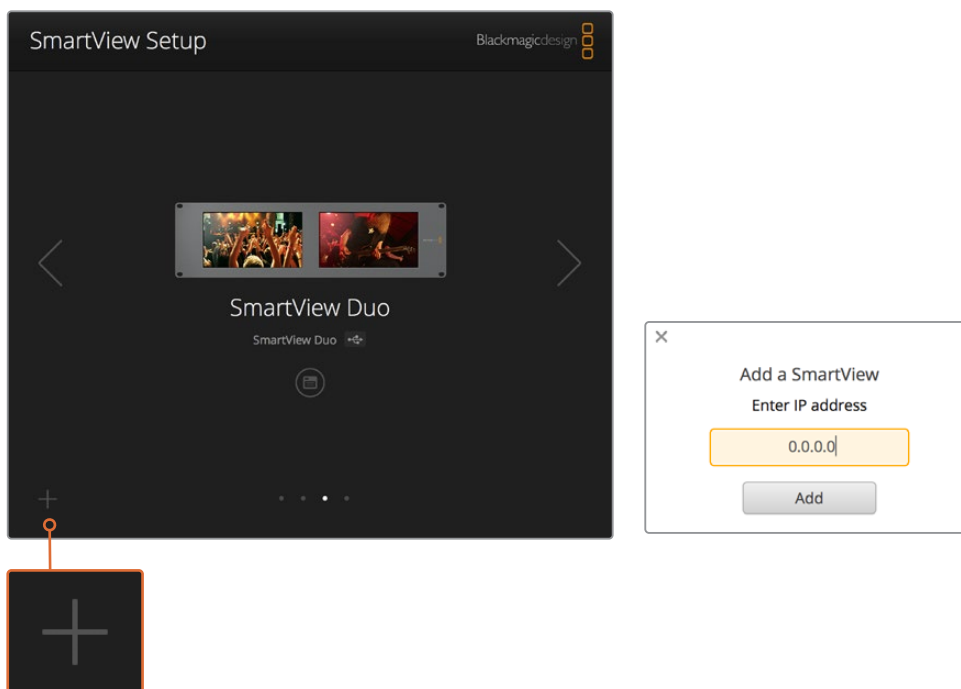

您可以点击“+”图标并键入该监视器的IP地址, 从而手动将SmartView或SmartScope监视器添加到所连接监视器列表中。

使用Tally

Tally端口引脚连接

如果您不打算使用Tally功能, 那就无需连接SmartView或SmartScope的Tally端口, 因此可以跳过这部分内容。

每台SmartView和SmartScope的监视屏都可独立显示Tally边框, 可显示红色、绿色或是蓝色, 分别用来指示视频信号正在播出、预览或是记录的状态。

9针D-sub Tally端口允许来自切换台和自动系统的触点闭合信号。使用您的切换台或自动系统时, 请参考所附的Tally引脚连接图所提供的Tally端口配线图信息。

9针D端口配线信息印于设备的后侧, 提供在每个独立监视屏上显示为红色、绿色或是蓝色Tally边框的触点闭合信息。

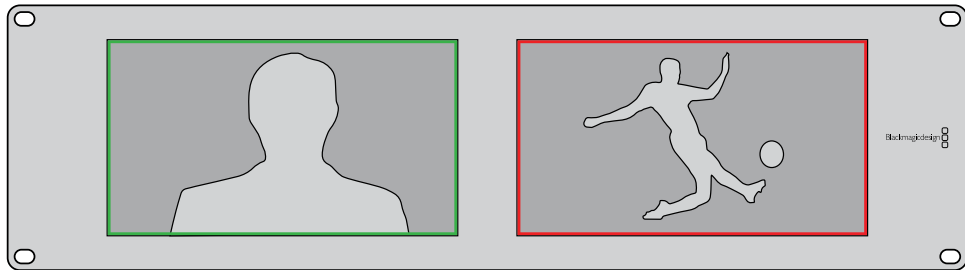

显示有绿色和红色Tally边框的SmartView Duo。

SmartView Duo和SmartScope Duo 4K Tally引脚连接图	
引脚	功能
1	监视屏1 红色
2	监视屏1 绿色
3	监视屏1 蓝色
4	接地
5	接地
6	接地
7	监视屏2 红色
8	监视屏2 绿色
9	监视屏2 蓝色

SmartView Tally端口

SmartView HD和SmartView 4K Tally引脚连接图	
引脚	功能
1	红
2	绿色
3	蓝色
4	接地

调整最佳监看角度

如果在设备机架的高处安装SmartView Duo、SmartView HD或是SmartScope监视器, 那么您可能想要反转LCD屏幕从而获得最佳的监看角度。当检测到屏幕翻转时, LCD屏幕上的图像将自动反转到正确的角度。将设备前面板与后半部分分离并重新安装回原位, 需要用到Pozidriv 2号螺丝刀。这一步骤非常简单, 不用打开设备后半部分的组装。

以下步骤介绍了设备如何反转安装设备, 并同时让前面板上的Blackmagic Design商标保持正确位置。此处需要用到Pozidriv 2号螺丝刀。

- 1 卸下前面板顶部、底部、左侧以及右侧的螺丝。SmartView Duo和SmartScope Duo 4K设有10枚螺丝, SmartView HD设有18枚螺丝。
- 2 如图所示, 将前面板提起, 使其与后半部分分离。
- 3 将后半部分反转。
- 4 将前面板安装到已反转的后半部分设备上。
- 5 重新将螺丝固定到机身。

您的SmartView或SmartScope已准备就绪, 可以安装到机架高处了。当安装到机架后, 即使有任何颠簸, SmartView都可继续以最佳可视角度显示, 因为没有任何可能导致出错或松动的外部旋钮或调整。



将设备安装在机架高处之前, 请先进行一个反转测试来检查最佳可视角度。

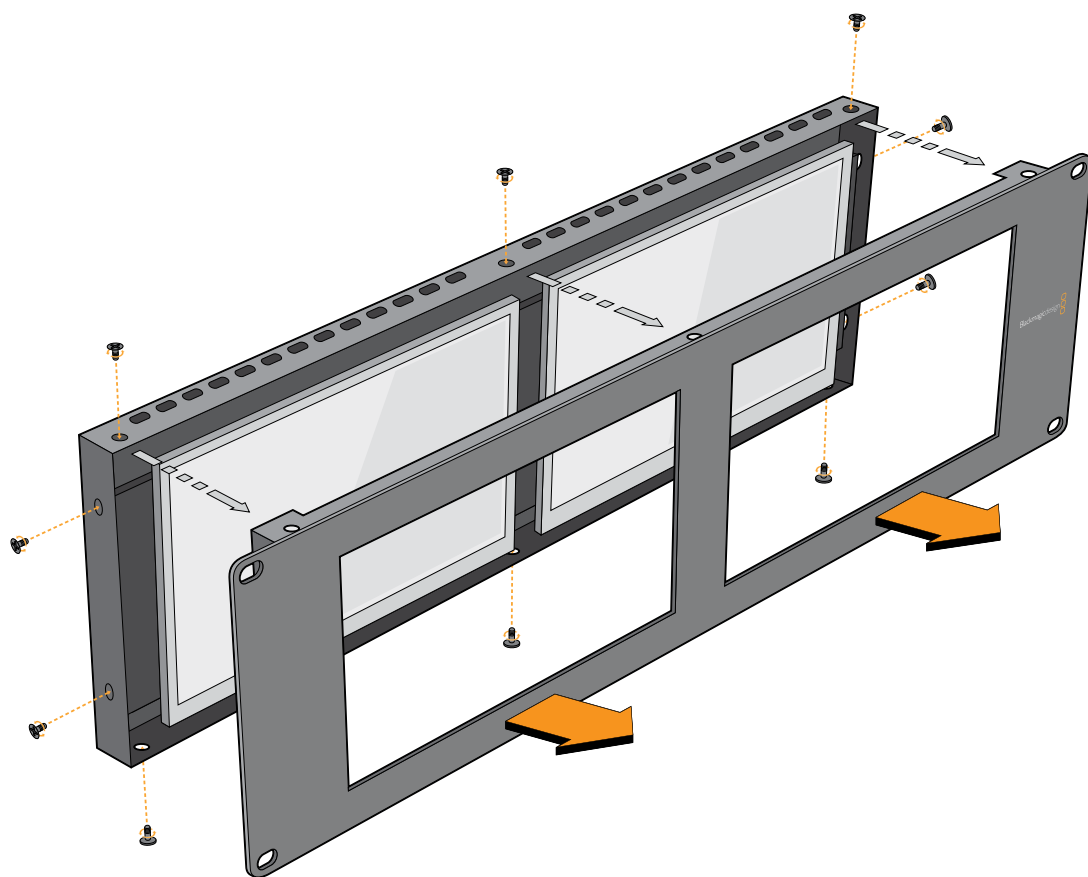

卸下所有螺丝, 将前面板与设备后半部分分离。

Developer Information

Developing Custom Software Using Blackmagic Design Hardware

The Blackmagic SmartView Ethernet Protocol allows developers to remotely control Blackmagic SmartView and SmartScope hardware with their own custom software. The Blackmagic SmartView Ethernet Protocol is a text-based status and control protocol.

Downloading the Free SmartView Ethernet Protocol

The Blackmagic SmartView Ethernet Protocol is free. It is included in this SmartView & SmartScope manual and can be downloaded from www.blackmagicdesign.com/cn/support

Joining the Blackmagic Design Developer List

The Blackmagic Developer mailing list is designed for technical questions regarding technologies used by Blackmagic Design, e.g., QuickTime, Core Media, DirectShow, codecs, APIs, SDKs, etc. The free mailing list is a forum where developers can discuss ideas and problems with other developers. Any subscriber may reply and the Blackmagic Design engineers may also respond when appropriate. You can subscribe to the mailing list at: <http://lists.blackmagicdesign.com/mailman/listinfo/bmd-developer>

In some cases, we might request a brief outline of the software you are developing if it is not immediately obvious from your domain name that your organization develops video software. Please don't take offence as we're simply trying to keep the list free of spam and viruses as well as end-user customers asking non-development questions, employment agents or sales people trying to promote products on the list. The list is just for developers.

Contacting Blackmagic Design Developer Assistance

You can also contact us via developer@blackmagicdesign.com if you have any developer related questions or wish to ask questions off the list.



Blackmagic 2K Format – Overview

Blackmagic Design products support 3G-SDI video, which allows twice the data rate of traditional HD-SDI video. We thought it would be a really nice idea to add 2K film support, via 3G-SDI technology, so we could simplify feature film workflows. With the popularity of Blackmagic Design editing systems worldwide, now thousands of people can benefit from a feature film workflow revolution.

This information includes everything product developers need to know for building native 2K SDI equipment. Of course, all Blackmagic products can be updated, so if the television industry adopts an alternative SDI-based film standard, we can add support for that too!

Frame Structure

- Transmitted at 23.98, 24 or 25 frames per second as a Progressive Segmented Frame.
- Active video is 2048 pixels wide by 1556 lines deep.
- Total lines per frame : 1650
- Active words per line are 1535. One word consists of a 10-bit sample for each of the four data streams, i.e., a total of 40 bits. See the diagram named Blackmagic 2K Format – Data Stream Format.
- Total active lines : 1556
- Total words per line : 1875 for 23.98/24Hz and 1800 for 25Hz.
- Fields per frame : 2, 825 lines each
- Active lines located on lines 16–793 (field 1) and 841–1618 (field 2).

Transport Structure

- Based on SMPTE 372M Dual Link mapping and SMPTE 425M–B support for mapping SMPTE 372M into a single 3 Gb/s link.
- Timing reference signals, line number and line CRC insertion is the same as above.
- During active video, 10-bit Red, Green and Blue data is sent in the following sequence:
- Optional ancillary data is inserted into both virtual interfaces.
- At present, only audio data is included: as per standard HD audio insertion (SMPTE S299M) the audio data packets are carried on data stream two and audio control packets are carried on data stream one.
 - Data stream 1: Green_1, Green_2, Green_3, Green_5...Green_2047
 - Data stream 2: Blue_1, Blue_2, Green_4, Blue_5...Green_2048.
 - Data stream 3: Red_1, Blue_3, Blue_4, Red_5...Blue_2048.
 - Data stream 4: Red_2, Red_3, Red_4, Red_6...Red_2048.

Blackmagic 2K Format – Vertical Timing Reference

This diagram shows the vertical timing details with line numbers and Field, Vertical and Horizontal bits for the Timing Reference Signal codes.

		Field 1					Active					
F	1	0	0	0	0	0	0	0	0	0	0	0
V	1	1	1	1	1	1	0	0	0	0	1	1
LINE #	1650	1	2	...	14	15	16	...	792	793	...	825

		Field 2					Active					
F	0	1	1	1	1	1	1	1	1	1	1	1
V	1	1	1	1	1	1	0	0	0	0	1	1
LINE #	825	826	827	...	839	840	841	...	1617	1618	...	1650

Blackmagic 2K Format – Data Stream Format

This diagram shows the data stream formats around the optional ancillary data section of the horizontal line. Note that each active pixel takes up three samples.

Word# 25 PsF	Word# 23.98/24 PsF	Data Stream 4	Data Stream 3	Data Stream 2	Data Stream 1
1795	1870	R2042	R2041	B2041	G2041
1796	1871	R2043	B2043	B2042	G2042
1797	1872	R2044	B2044	G2044	G2043
1798	1873	R2046	R2045	B2045	G2045
1799	1874	R2047	B2047	B2046	G2046
1800	1875	R2048	B2048	G2048	G2047
1	1	EAV(3FFh)	EAV(3FFh)	EAV(3FFh)	EAV(3FFh)
2	2	EAV(000h)	EAV(000h)	EAV(000h)	EAV(000h)
3	3	EAV(000h)	EAV(000h)	EAV(000h)	EAV(000h)
4	4	EAV(XYZh)	EAV(XYZh)	EAV(XYZh)	EAV(XYZh)
5	5	LN0	LN0	LN0	LN0
6	6	LN1	LN1	LN1	LN1
7	7	CRC0	CRC0	CRC0	CRC0
8	8	CRC1	CRC1	CRC1	CRC1
9	9	200	040	ANC/Audio Data	ANC/Audio Data
...		
260	335	200	040		
261	336	SAV(3FFh)	SAV(3FFh)	SAV(3FFh)	SAV(3FFh)
262	337	SAV(000h)	SAV(000h)	SAV(000h)	SAV(000h)
263	338	SAV(000h)	SAV(000h)	SAV(000h)	SAV(000h)
264	339	SAV(XYZh)	SAV(XYZh)	SAV(XYZh)	SAV(XYZh)
265	340	R2	R1	B1	G1
266	341	R3	B3	B2	G2
267	342	R4	B4	G4	G3
268	343	R6	R5	B5	G5

Blackmagic SmartView Ethernet Protocol v1.3

Summary

The Blackmagic SmartView Ethernet Protocol is a text-based status and control protocol, very similar in structure to the Videohub protocol, that is accessed by connecting to TCP port 9992 on a SmartView or SmartScope device.

Upon connection, the SmartView or SmartScope device sends a complete dump of the state of the device. After the initial dump, state changes are sent asynchronously.

The device sends information in blocks which have an identifying header, followed by a colon. A block can span multiple lines and is terminated by a blank line.

To be resilient to future protocol changes, clients should ignore blocks they do not recognize, up to the trailing blank line. Within recognized blocks, clients should ignore lines they do not recognize.

Legend

↵ carriage return
... and so on

Version 1.3 of the Blackmagic SmartView Ethernet Protocol was released with SmartView 1.3 software.

Protocol Preamble

The first block sent by the SmartView Server is always the protocol preamble:

```
PROTOCOL PREAMBLE:↵  
Version: 1.3 ↵  
↵
```

The version field indicates the protocol version. When the protocol is changed in a compatible way, the minor version number will be updated. If incompatible changes are made, the major version number will be updated.

Device Information

The next block contains general information about the connected SmartView or SmartScope device.

```
SMARTVIEW DEVICE:↵  
Model: SmartView Duo↵  
Hostname: stagefront.studio.example.com↵  
Name: StageFront↵  
Monitors: 2↵  
Inverted: false↵  
↵
```

This example shows the output for a SmartView Duo device, which has two LCDs. The INVERTED flag indicates whether the device has detected that it has been mounted in an inverted configuration to optimize LCD viewing angle.

Network Configuration

The next block shows the TCP/IP networking configuration:

```
NETWORK:↵
Dynamic IP: true↵
Static address: 192.168.2.2↵
Static netmask: 255.255.255.0↵
Static gateway: 192.168.2.1↵
Current address: 192.168.1.101↵
Current netmask: 255.255.255.0↵
Current gateway: 192.168.1.1↵
↵
```

The network settings prefixed with CURRENT show the active TCP/IP settings, and are read-only. The CURRENT settings reflect either the DHCP or Static configuration, depending on the DYNAMIC IP flag.

Changing Networking Settings

The network can be configured to use either DHCP or a static configuration. To enable DHCP:

```
NETWORK:↵
Dynamic IP: true↵
↵
```

To set a fixed IP address, supply all static parameters, thus:

```
NETWORK:↵
Dynamic IP: false↵
Static address: 192.168.2.2↵
Static netmask: 255.255.255.0↵
Static gateway: 192.168.2.1↵
↵
```

The parameters with the CURRENT prefix are read-only, and show the active configuration, regardless of the static or dynamic setting.

Changing the device name, or any network settings, will cause the IP connection to be dropped. The device will restart its networking and advertise its new name on the network.

Changing Monitor Settings

The display settings for each monitor are specified individually. One or more parameters can be modified at the same time and multiple settings can be supplied in one block.

The valid range for numeric values is 0–255. The CONTRAST and SATURATION properties are zero-centered, so the normal value is 127, such that the displayed picture is the same as the original. A value greater than 127 in either channel will cause the contrast or saturation to be increased, and similarly a value less than 127 will cause a decrease.

For example, to set the brightness to 50% and desaturate the image to Black & White:

```
MONITOR A:↵
Brightness: 127↵
Saturation: 0↵
↵
```

Displaying SD in 16:9

The following command sets standard definition video to display in 16:9:

```
MONITOR A:↵  
WidescreenSD: ON↵
```

Displaying SD in 4:3

The following command sets standard definition video to display in 4:3:

```
MONITOR A:↵  
WidescreenSD: OFF↵
```

Identification and Tally Settings

The Identify flag is transient, and will cause a white border to be displayed around the entire picture for a duration of 15 seconds, after which it will be reset. This feature is primarily aimed at identifying which monitor is currently being configured when it is mounted in a rack comprising multiple units. To turn on:

```
MONITOR A:↵  
Identify: true↵  
↵
```

The IDENTIFY border will temporarily override any other border setting in effect.

The BORDER property can be used to programmatically set the soft Tally colored borders to one of the primary colors: RED, GREEN, BLUE, WHITE or NONE. This setting can be overridden by the electrical Tally signals at the DB-9 input on the device itself. For example, to set the soft Tally to green:

```
MONITOR B:↵  
Border: green↵  
↵
```

The hard wired tally will always override the soft tally. The full state report will always show the current valid border.

SmartScope Settings

On SmartScope Duo 4K, each monitor can be set to display a different scope. The values for activating specific scopes are mapped as follows:

- AudioDbfs
- AudioDbvu
- Histogram
- ParadeRGB
- ParadeYUV
- Picture (This is the same as Video Monitor)
- Vector100
- Vector75
- WaveformLuma

```
MONITOR A:↵  
ScopeMode: Picture↵  
↵
```

In the example above, Monitor A has been set as a video monitor.

Displaying SD in 16:9

The set Video Monitor mode to display standard definition video in 16:9:

```
MONITOR A:↵  
ScopeMode: Picture↵  
WidescreenSD: ON↵
```

Displaying SD in 4:3

To set Video Monitor mode to display standard definition video in 4:3:

```
MONITOR A:↵  
ScopeMode: Picture↵  
WidescreenSD: OFF↵
```

When setting one of SmartScope Duo 4K's monitors to audio metering, you can also select which channels to show. The values for selecting which audio channels are mapped in the following way:

- 0: Channels 1 and 2
- 1: Channels 3 and 4
- 2: Channels 5 and 6
- 3: Channels 7 and 8
- 4: Channels 9 and 10
- 5: Channels 11 and 12
- 6: Channels 13 and 14
- 7: Channels 15 and 16

```
MONITOR B:↵  
ScopeMode: AudioDbvu↵  
AudioChannel: 0↵  
↵
```

In the example above, Monitor B has been selected to display Audio Metering in Dbvu with audio channels 1 and 2 selected for the phase meter.

Selecting LUTs for SmartView 4K

To select 3D LUTs using SmartView 4K:

```
MONITOR A:↵  
LUT: 0          LUT 1  
      1          LUT 2  
      NONE      DISABLE  
↵  
↵
```

帮助

获得帮助

获得帮助的渠道有以下四种：

- 1 查看Blackmagic Design支持中心网址www.blackmagicdesign.com/cn/support获得致电Blackmagic Design经销商。
- 2 您所在地区的经销商拥有Blackmagic Design的最新技术信息，并能立即为您提供帮助。
- 3 我们同时建议您查看经销商所提供的支持选择，因为他们可以根据您的工作流程需要安排不同的支持计划。
- 4 您还可以通过www.blackmagicdesign.com/cn/support网站里的“给我们发送电子邮件”按钮通过电子邮件向我们询问问题。
- 5 致电Blackmagic Design支持中心。您可以点击支持页面下方的“查找您所在地区的支持团队”按钮，找到距离您最近的支持中心获得帮助。

请尽可能详尽描述您所遇到的技术问题和系统规格，以便我们能尽快解答您的疑问。

监管声明

在欧盟范围内处置电子垃圾和电子设备的注意事项。



根据产品所附的提示标志, 本设备不得与其它废弃材料共同处置。处置废弃设备时, 必须交给指定收集点进行回收。对废弃设备进行单独收集并回收能够节省自然资源, 且回收方式不会损害环境和人体健康。获取更多关于废弃设备回收点的信息, 请联系您所在城市的回收站, 或当时购买设备的经销商。



本设备经过测试, 符合FCC规则的第15部分对A类数字设备的限制。这些限制旨在为运行于商业环境中的设备提供合理保护, 使其免受有害干扰的影响。本设备可生成、使用且辐射射频能量, 如果未按照安装手册来安装和使用本设备, 则可能导致对无线电通信的有害干扰。在住宅区运行本产品可能会产生有害干扰, 在这种情况下将由用户自行承担消除干扰的费用。

必须满足以下条件后方可操作:

- 1 设备不会造成有害干扰。
- 2 设备必须能够承受任何干扰, 包括可能导致意外操作的干扰。

—



MSIP-REM-BMD-201410001
MSIP-REM-BMD-20150327
MSIP-REM-BMD-201702004
MSIP-REM-BMD-201702005

加拿大ISED认证声明

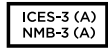

本设备符合加拿大A类数码产品的相关标准。

任何对本产品的改装或预期用途之外的使用均可能导致相关标准认证无效。

必须使用有高品质屏蔽的HDMI电缆连接HDMI接口。

本设备经检测符合商业环境使用要求。在家用环境中, 本设备可能会造成无线电干扰。

安全信息

为避免触电，设备必须连接在配有保护地线的电源插座。如有疑问，请与具有相关资质的电工进行确认。

为了降低触电风险，请勿将设备放在会滴水或溅水的地方。

本产品适合在环境温度低于40°C的热带地区使用。

确保设备四周留有足够的空间，不受阻碍。

安装在机架上时，确保相邻设备不会影响通风。

设备内部没有操作人员可维护的零件。如需维修，请联系当地Blackmagic Design服务中心。

一些产品具有连接小型收发器 (SFP) 光纤模块的功能。仅使用Laser Class 1光纤SFP模块。

建议使用的Blackmagic Design SFP模块：

- **3G-SDI** PL-4F20-311C
- **6G-SDI** PL-8F10-311C
- **12G-SDI** PL-TG10-311C



请在海拔高度2000米以下的地区使用。

加利福尼亚安全声明

该产品可能会让您暴露在塑料部件中所含的微量多溴化联苯等化学物质下，此类物质已被加州政府认定为可能导致癌症、先天畸形或其他遗传危害的物质。

详情请访问网址：www.P65Warnings.ca.gov

保修

12个月有限保修

Blackmagic Design保证本产品自购买之日起12个月内不会有材料和工艺上的缺陷。若本产品在其保修期内出现质量问题, Blackmagic Design可选择为产品提供免费修理或更换零部件, 或者更换缺陷产品。

为确保消费者有权享受本保修条款中的服务, 如遇产品质量问题请务必在保修期内联系Blackmagic Design并妥善安排保修事宜。消费者应将缺陷产品包装并运送到Blackmagic Design的指定服务中心进行维修, 运费由消费者承担并预先支付。若消费者因任何原因退货, 所有运费、保险费、关税等各项税务以及其他费用均由消费者承担。

本保修条款不适用于任何因使用、维护不当或保养不周造成的缺陷、故障或损坏。根据本保修服务, Blackmagic Design的保修服务范围不包括以下内容: 1. 对由非Blackmagic Design专门人员进行的安装、维修或保养所造成的损坏进行维修, 2. 对因使用不当或连接到不兼容设备所造成的损坏进行维修, 3. 对因使用了非Blackmagic Design生产的零部件所导致的损坏或故障进行维修, 及 4. 对经过改装或其他产品进行组装的产品进行保养维修 (因为产品经改装或组装后会增加保养维修所需时间或保养难度)。本保修条款由BLACKMAGIC DESIGN提供, 它可取代所有其他明示或隐含的保修。BLACKMAGIC DESIGN及其供应商对任何有关适用性及就特定用途的适用性等隐含保证不作任何担保。BLACKMAGIC DESIGN负责为消费者提供缺陷产品的维修或更换服务是完整和排他性补救措施, 不论BLACKMAGIC DESIGN或其供应商是否事先获悉发生间接、特殊、偶然或必然损坏等损坏的可能性。若消费者对本设备进行非法使用, BLACKMAGIC DESIGN概不负责。对因使用本产品造成的损失, BLACKMAGIC DESIGN概不负责。本产品的操作风险由用户自行承担。

© Copyright 2020 Blackmagic Design 保留一切权利。“Blackmagic Design”、“DeckLink”、“HDLink”、“Workgroup Videohub”、“Multibrige Pro”、“Multibrige Extreme”、“Intensity”以及“Leading the creative video revolution”均为美国及其他国家的注册商标。所有其他公司名称及产品名称可能是其他所有者的注册商标。



설치 및 사용 설명서

SmartView & SmartScope

2020년9월

한국어



환영합니다.

모두가 고품질의 비디오를 사용할 수 있도록 하여 TV 산업을 진정한 창조 산업으로 발전시켜 나가려는 저희의 꿈에 동참할 수 있기를 희망합니다.

비디오 모니터링은 시설 어디에서나 필요합니다. SmartView 4K는 기본 4K LCD를 탑재해 UHD 비디오를 풀 해상도로 확인할 수 있으며, 두께가 얇은 6RU 크기의 하우징에 컨트롤 패널까지 탑재해 설정을 신속하게 변경할 수 있습니다. SmartView HD는 6RU 크기의 랙 하우징에 놀라운 17인치 LCD를 탑재했으며 두께는 1인치 미만입니다. SmartView Duo는 3RU 크기의 하우징에 완전히 독립적이고 아름다운 두 개의 8인치 LCD를 탑재했으며 두께는 1인치 미만입니다. SmartScope Duo 4K는 파형 스코프 기능을 지원하는 두 개의 개별 8인치 LCD를 탑재해 비디오 레벨을 실시간으로 확인할 수 있습니다. 모든 SmartView 모니터는 3G-SDI를 통해 SD/HD/2K 비디오를 지원합니다. SmartScope Duo 4K와 SmartView 4K는 각각 6G-SDI 및 12G-SDI를 통해 UHD 4K 또한 지원합니다.

비디오 모니터링은 구입하자마자 바로 사용할 수 있으며, 사용이 쉽고 직관적인 환경 설정 도구인 Blackmagic SmartView 설치 소프트웨어까지 제공됩니다.

본 사용 설명서는 SmartView 또는 SmartScope의 설치와 관련된 모든 정보를 담고 있지만, IP 주소나 컴퓨터 네트워크에 대한 지식이 부족할 경우에는 기술 지원을 요청하는 것이 좋습니다. SmartView와 SmartScope는 설치가 간단하지만 설치를 마친 후에 몇 가지 기술적 설정 사항을 적용해야 할 수도 있습니다.

설치가 완료되기까지는 약 5분 정도의 시간이 소요됩니다. 저희 웹사이트 (www.blackmagicdesign.com/kr)에 방문하여 고객 지원 페이지에서 최신 버전의 설명서와 SmartView 소프트웨어를 다운로드하세요. 소프트웨어를 다운로드할 때 사용자 정보를 등록하시면, 새로운 소프트웨어가 출시될 때마다 업데이트 소식을 받아보실 수 있습니다. 저희는 새로운 기능과 제품 개선을 위해서 끊임없이 노력하고 있으며 항상 고객 여러분의 의견을 기다립니다!

Blackmagic Design의 CEO
그랜트 패티

목차

SmartView & SmartScope

시작하기	245
SmartView 및 SmartScope 소개	245
비디오 소스 연결하기	246
컴퓨터에 연결하기	246
Blackmagic SmartView Setup 소프트웨어 설치하기	247
Blackmagic SmartView Setup 소프트웨어 사용하기	248
소프트웨어 업데이트	248
모니터 설정 조정하기	248
탈리 오버라이드 활성화	251
SmartView 4K 사용하기	251
Blackmagic SmartView 4K 소개	251
컨트롤 패널 버튼	252
Blackmagic SmartView Setup을 사용해 3D LUT 로딩하기	254
SmartScope Duo 4K 사용하기	255
Blackmagic SmartScope이란?	255
비디오 모니터링(Video Monitoring) 디스플레이	256
파형(Waveform) 디스플레이	257
벡터 스코프(Vectorscope) 디스플레이	258
퍼레이드(Parade) 디스플레이	259
히스토그램(Histogram) 디스플레이	261
오디오 미터링 표시	262
네트워크에 연결하기	263
다이렉트 이더넷	263
이더넷 네트워크 스위치	264
네트워크 설정 조정하기	265
네트워크 설정	265
Blackmagic 모니터 추가하기	267
탈리 사용	268
탈리 포트 핀 연결	268
시야각 최적화하기	269
Developer Information	271
Blackmagic 2K Format – Overview	271
Blackmagic 2K Format – Vertical Timing Reference	272
Blackmagic 2K Format – Data Stream Format	273
Blackmagic SmartView Ethernet Protocol v1.3	274
지원	278
규제 사항	279
안전 정보	280
보증	281

시작하기

SmartView 및 SmartScope 소개

SmartView 모니터는 랙 기반의 모니터링을 필요로 하는 모든 시설에서 사용하기에 완벽합니다. 전원을 연결하여 SDI 소스를 연결해주기만 하면 곧바로 사용할 수 있습니다.

SmartView 4K는 15.6인치 4K LCD를 탑재해 SD, HD, UHD 비디오를 원본 3840x2160 픽셀 해상도로 모니터링할 수 있습니다. 전면 컨트롤 패널 버튼을 통해 입력 선택과 화면 밝기 조정, 블루 채널 노이즈 확인, 블랭킹 정보 보기, 3D LUT 적용 등의 작업을 수월하게 진행할 수 있습니다.

SmartView HD는 17인치 HD LCD 모니터를 탑재해 풀 해상도의 HD 영상을 자신감 있게 모니터링할 수 있습니다.

SmartView Duo는 서로 다른 비디오 신호를 동시에 디스플레이할 수 있는 두 개의 모니터를 탑재했습니다. 예를 들어, 한 모니터에서 RGB 4:4:4를 수신하는 동안 다른 모니터에서 YUV 4:2:2 신호를 디스플레이할 수 있습니다. 두 모니터에서 각각 NTSC와 PAL 신호를 디스플레이할 수 있습니다. 여러 가지 조합이 가능하지만 이들 모두 싱글 SDI 케이블을 각 모니터에 연결하는 것만큼이나 간단합니다.

SmartScope Duo 4K는 SmartView Duo의 모든 기능을 지원할 뿐 아니라 파형, 벡터 스코프, 인기 스코프를 디스플레이하여 비디오 및 오디오 레벨을 실시간으로 모니터링할 수 있습니다. 여기에 UHD 4K까지 완벽하게 지원합니다!

SmartView 및 SmartScope 모니터의 모든 SDI 입력 연결은 2K 비디오를 포함한 SD, HD, 3G-SDI 자동 감지 기능을 지원합니다. SmartView 4K에서는 12G-SDI를 통해 2160p60 등의 UHD 포맷 또한 감지합니다. SmartScope Duo 4K에서는 6G-SDI를 통해 UHD 4K 비디오를 자동으로 감지합니다.

한 대의 컴퓨터에서 여러 대의 SmartView 및 SmartScope 유닛의 설정을 원격으로 조절하려면 이들 모두 이더넷을 통해 연결하세요. 다시 말해, 설정을 변경할 때마다 컴퓨터 연결용 USB 케이블을 들고 각 유닛 사이를 돌아다닐 필요가 없습니다.

이제 사용 준비가 모두 완료되었습니다! 본 사용 설명서를 계속 읽으면서 SmartView 및 SmartScope 연결과 Blackmagic SmartView 설치 프로그램에서의 모니터 설정 환경 설정, 네트워크 연결에 관한 자세한 정보를 확인하세요.



SmartView 4K



SmartView HD



SmartView Duo



SmartScope Duo 4K

비디오 소스 연결하기

SmartView 및 SmartScope 모니터는 일반 BNC 커넥터를 탑재해 스위처, 카메라, 캡처 카드, 데스크, 디스크 레코더 등의 SDI 장비를 연결할 수 있습니다.

살펴보기

비디오를 쉽게 디스플레이할 수 있습니다! 유닛 전원을 켜고 비디오 소스를 SDI 입력에 연결하기만 하면 됩니다. 전원을 연결해 소스를 연결하고 나면 비디오가 나오는 것을 바로 확인할 수 있습니다. SD, HD, 2K 신호는 SDI 입력 및 루프스루 출력 연결을 통해 자동 감지됩니다. SmartView 4K와 SmartScope Duo 4K에서는 UHD 4K까지 감지합니다.

유닛에 비디오가 전송되지 않으면 유효 신호가 전송될 때까지 전원을 절약하기 위해 배면광에 불이 들어오지 않습니다.

데이지 체이닝 모니터

각 SmartView 및 SmartScope 모니터에는 루프스루 출력뿐 아니라 개별 SDI 입력이 탑재되어 있어 여러 대의 모니터를 함께 연결해 동일한 입력 신호를 디스플레이할 수 있습니다.

- 1 첫 번째 유닛의 전원을 켜세요. 비디오 소스 신호를 SDI 입력에 연결하세요. 비디오가 화면에 바로 나타납니다.
- 2 두 번째 유닛의 전원을 켜세요. SDI 케이블을 사용해 첫 번째 유닛의 루프스루 출력과 두 번째 유닛의 SDI 입력을 연결하세요.

원하는 유닛을 무제한으로 체인 연결할 수 있습니다.

SmartScope Duo 4K를 사용해 파형을 모니터링하는 경우 모니터 1 출력을 모니터 2로 루프 출력해 두 디스플레이 모두 동일한 입력 신호를 사용하게 할 수도 있습니다.

비디오가 디스플레이되면 Blackmagic SmartView 설치 프로그램을 사용해 SmartScope Duo 4K의 모니터 설정을 조정하거나 스코프를 선택할 수 있으며, Blackmagic SmartView 4K에 3D LUT을 로딩할 수도 있습니다.



SmartView 4K

SmartView HD



SmartView Duo

SmartScope Duo 4K

컴퓨터에 연결하기

USB를 통해 컴퓨터와 SmartView 또는 SmartScope를 연결한 뒤, Blackmagic SmartView Setup 소프트웨어를 설치해 모니터 설정을 조정할 수 있습니다.

USB 연결을 통해 Blackmagic Design 웹사이트에서 다운로드한 내부 소프트웨어를 업데이트할 수도 있습니다. 소프트웨어 업데이트는 새로운 기능과 새로운 하드웨어 호환성, 새로운 포맷 지원 기능 등을 제공합니다. Blackmagic SmartView Setup 소프트웨어는 macOS와 Windows를 모두 지원합니다.

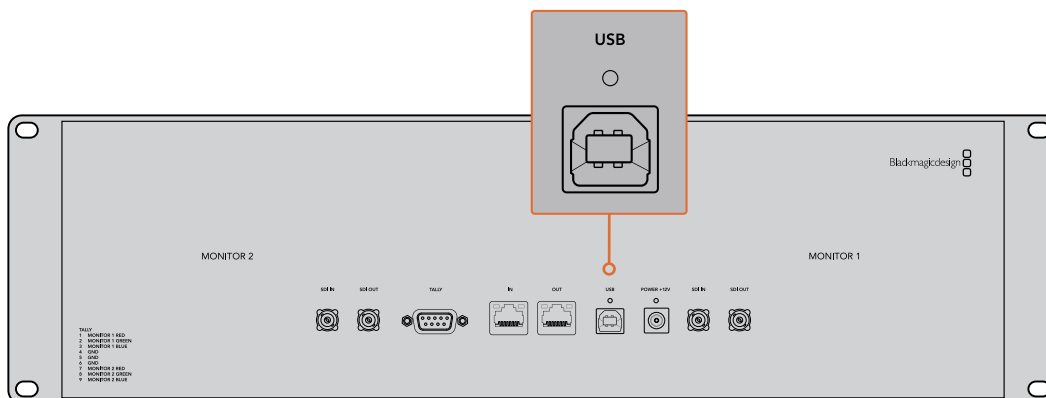

Blackmagic SmartView Setup 소프트웨어 설치하기

Blackmagic SmartView Setup 소프트웨어는 macOS 최신 버전인 Sierra 및 High Sierra와, 최신 서비스 팩이 설치된 64 비트 버전의 Windows 8.1/10에서 운용됩니다. 원할 경우, Blackmagic SmartView Setup 소프트웨어를 네트워크에 연결된 여러 대의 컴퓨터에 설치할 수 있습니다.

SmartView와 함께 제공되는 SD 카드에 소프트웨어 설치자가 포함되어 있지만 www.blackmagicdesign.com/kr/support에서 최신 버전의 소프트웨어를 다운받는 것이 좋습니다.

macOS에 설치하는 방법

제품에 포함된 SD 카드나 다운로드한 디스크 이미지를 열고, Install SmartView 아이콘을 더블 클릭하세요. 응용 프로그램 폴더에 SmartView 폴더가 생성되며, 여기엔 SmartView Setup 소프트웨어와 기존 버전 제거 프로그램, 본 사용 설명서 및 기타 SmartView 정보가 담긴 Documents 폴더가 포함되어 있습니다.

Windows에 설치하는 방법

Windows에서 제품에 포함된 SD 카드나 다운로드한 압축 파일을 열고, Install SmartView 설치 프로그램을 더블 클릭하세요. 화면에 나타나는 지시 사항에 따라 소프트웨어를 설치하세요.

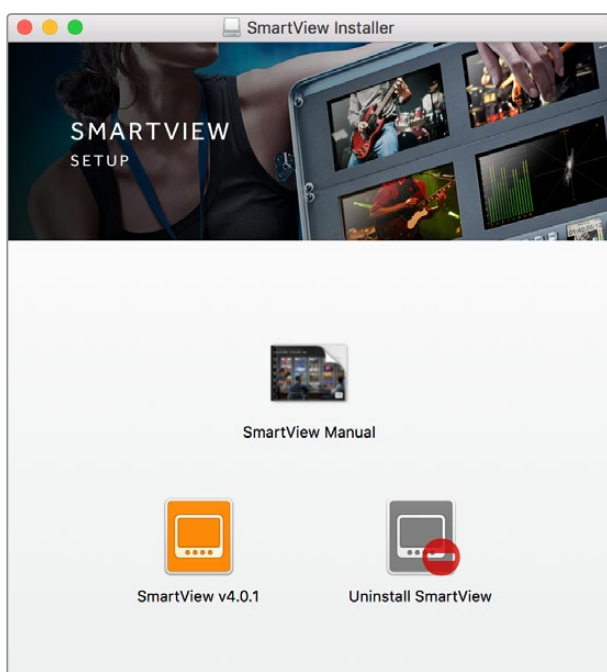

macOS에 설치하려면 제품과 함께 제공된 SD 카드나 다운로드 폴더에 있는 SmartView.dmg 파일을 실행한 뒤, Install SmartView 아이콘을 더블 클릭하세요.

Blackmagic SmartView Setup

소프트웨어 사용하기

소프트웨어 업데이트

Blackmagic SmartView Setup 소프트웨어를 설치 및 실행한 뒤, 현재 연결된 모니터 이름 아래쪽에 있는 설정 아이콘을 클릭하세요. SmartView 또는 SmartScope의 내부 소프트웨어를 업데이트하라는 메시지가 나타납니다. 다음 순서에 따라 업데이트를 진행하세요.

- 1 USB나 이더넷을 통해 SmartView 또는 SmartScope를 컴퓨터와 연결한 뒤, Blackmagic SmartView Setup 소프트웨어를 실행하세요.
- 2 메시지 창이 나타나면 간단히 Update를 클릭하세요. 업데이트가 완료되기까지 5분 정도 소요됩니다.
- 3 업데이트가 완료되면 [This SmartView has been updated]라는 메시지가 나타납니다.
- 4 [Close] 버튼을 누르세요.

내부 소프트웨어를 업데이트할 필요가 없는 경우 Blackmagic SmartView Setup 소프트웨어에서 모니터 설정 페이지가 열립니다.

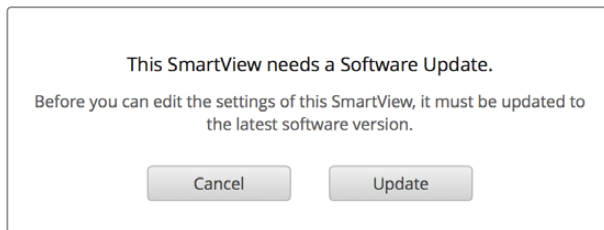

SmartView Setup 소프트웨어를 실행한 뒤 연결된 SmartView 또는 SmartScope의 설정 아이콘을 열었을 때, 내부 소프트웨어 업데이트가 필요하면 해당 메시지가 나타납니다.

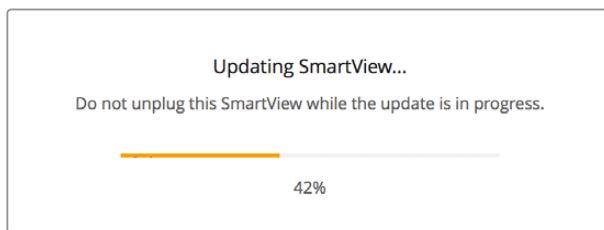

업데이트가 완료되기까지 5분 정도 소요됩니다.

모니터 설정 조정하기

Blackmagic SmartView Setup 소프트웨어를 실행하면 USB나 이더넷을 통해 연결된 모든 SmartView 또는 SmartScope를 즉각 검색한 뒤, 해당 유닛을 SmartView Setup 홈페이지에 나타냅니다. 네트워크에 연결된 Blackmagic 모니터가 한 대 이상일 경우 홈페이지 양쪽에 있는 좌/우 화살표 아이콘을 사용해 조정하고자 하는 모니터를 선택하세요. USB를 통해 Blackmagic 모니터를 연결한 경우, 모니터 이름 옆에 USB 아이콘이 나타납니다.

설정을 조정하려면 이더넷 또는 USB를 통해 연결된 모니터를 선택한 뒤, 해당 모니터 이름 아래 있는 설정 아이콘을 클릭하세요. 그러면 선택한 모니터의 설정 페이지가 열립니다. 원하는 설정으로 변경했다면 Save 버튼을 눌러 설정을 저장하고 SmartView Setup 시작 화면으로 돌아가세요.

Blackmagic 모니터에서 사용 가능한 설정과 이를 적용하는 방법에 대한 정보는 다음 섹션에서 확인하실 수 있습니다. Blackmagic SmartView Setup 소프트웨어를 사용해 네트워크 설정을 조정하는 방법에 대한 자세한 정보는 [네트워크 연결 조정하기] 부분을 참고하세요.

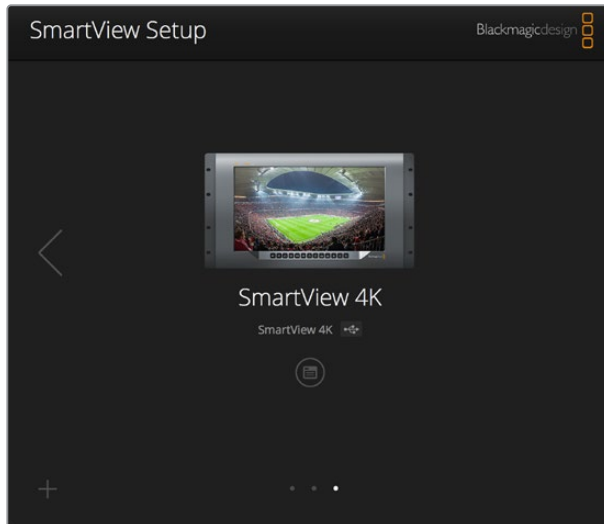

Blackmagic SmartView Setup 소프트웨어에서는 USB 또는 네트워크를 통해 연결된 모든 SmartView 및 SmartScope 유닛을 자동으로 검색합니다. 모니터의 내부 소프트웨어 업데이트 시 모니터가 USB 또는 이더넷을 통해 연결되어 있는지 반드시 확인하세요. 모니터 이름 옆에 USB 아이콘이 나타납니다.

모니터 설정

각 모니터의 설정 및 디스플레이 조정은 모니터가 USB 또는 이더넷을 통해 연결되어 있는 경우에만 가능합니다. SmartView Setup 홈페이지에 있는 좌/우 화살표 아이콘을 사용해 설정하고자 하는 모니터를 선택한 다음 모니터 이름 옆에 아래에 있는 설정 아이콘을 클릭하세요. 이 설정 페이지는 선택한 Blackmagic 모니터에서 지원하는 기능에 맞게 자동으로 커스터마이징됩니다.

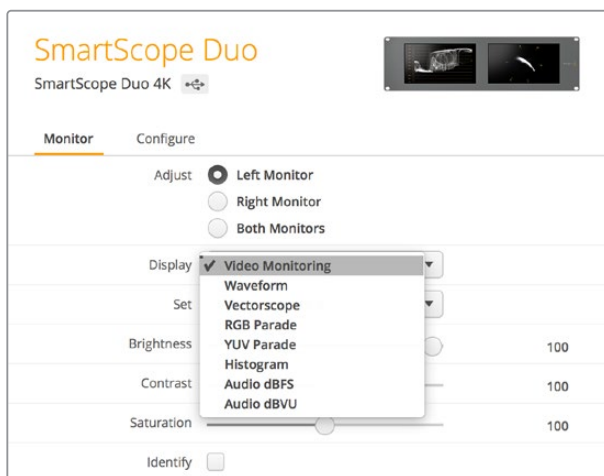

SmartScope의 경우, Display 드롭다운 메뉴에서 스코프 또는 비디오 모니터링 중 원하는 것을 선택할 수 있습니다.

조정(Adjust)

SmartScope 또는 SmartView Duo를 사용할 경우, Left Monitor/Right Monitor/Both Monitors 중 하나를 골라 조정하고자 하는 모니터를 선택하세요. 두 모니터를 동시에 조정할 수도 있습니다. Both Monitors를 선택한 다음 밝기/콘트라스트/채도를 변경할 경우, 해당 변경 사항이 SmartView Duo 및 SmartScope의 양쪽 모니터에 적용됩니다.

디스플레이(Display)

SmartScope를 사용할 경우, Display 드롭다운 메뉴에 선택 가능한 스코프 옵션이 나타납니다. 비디오 이미지를 확인하고자 할 경우엔 Video Monitoring을 선택하세요.

설정(Set)

SmartScope에서 SD 비디오를 사용할 경우, Set 드롭다운 메뉴를 통해 비디오 모니터링 디스플레이를 위한 4:3 또는 16:9 종횡비를 선택할 수 있습니다. Set 드롭다운 메뉴에서는 선택한 디스플레이를 위한 벡터 스코프, 오디오 dBFS, 오디오 dBVU 등의 추가 옵션을 제공합니다.

- **Video Monitoring:** 비디오 이미지를 4:3 또는 16:9 종횡비 보기로 선택할 수 있습니다.
- **와이드스크린 애너모픽 SD 비디오를 모니터링할 경우, 16:9 종횡비를 선택하세요.** 기존의 4:3 SD 비디오를 모니터링할 경우, 4:3 종횡비를 선택하세요.
- **Vectorscope:** 입력을 기반으로 100% 또는 75% 컬러바 테스트 신호를 선택하세요.
- **Audio dBFS:** 위상 모니터링에 사용할 오디오 채널을 선택하세요.
- **Audio dBVU:** 위상 모니터링에 사용할 오디오 채널을 선택하세요.

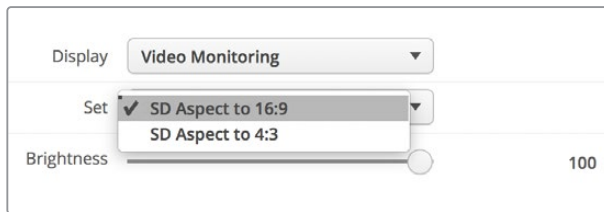

애너모픽 SD 비디오를 모니터링할 경우, [SD Aspect to 16:9]로 설정하세요.

밝기, 콘트라스트, 채도(Brightness, Contrast, Saturation)

슬라이더를 조절해 밝기, 콘트라스트, 채도 설정을 적용하세요. 사용 가능한 설정은 SmartView와 SmartScope 모델에 따라 달라집니다.

모니터 테두리 표시

Identify 확인란을 활성화하면 Blackmagic SmartView Setup에서 선택한 모든 모니터에 흰색 테두리가 나타납니다. 네트워크를 통해 여러 대의 SmartView 및 SmartScope 유닛을 연결한 경우 이 설정을 통해 선택된 모니터를 쉽게 식별할 수 있습니다.

이 설정을 Both Monitors 설정과 함께 사용할 경우 SmartView Duo 또는 SmartScope Duo 4K의 모든 모니터에 흰색 테두리가 나타납니다.

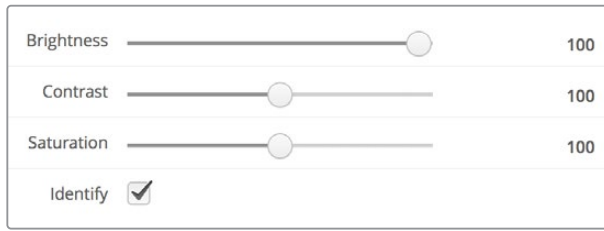

슬라이더를 좌/우로 드래그하여 대비, 채도 설정을 조절합니다. 선택한 모니터를 시각적으로 확인하려면 Identify 설정을 확인하세요.

탈리 오버라이드 활성화

'Enable tally override'를 선택하면 Blackmagic SmartView 4K의 탈리 보더가 활성화됩니다. 이 기능은 Blackmagic URSA Mini Pro 4.6K 및 Blackmagic URSA Broadcast와도 호환됩니다.

카메라의 SDI 출력을 SmartView 4K의 입력 A 또는 입력 B에 연결하세요.

ATEM 스위치의 프로그램 출력을 카메라 SDI 입력에 연결하세요.

ATEM 스위처에서 카메라 출력을 프로그램 출력으로 전환하면, SmartView 4K에 빨간색 탈리 보더가 나타납니다. 미리보기 출력으로 전환하면 초록색 탈리 보더가 나타납니다.

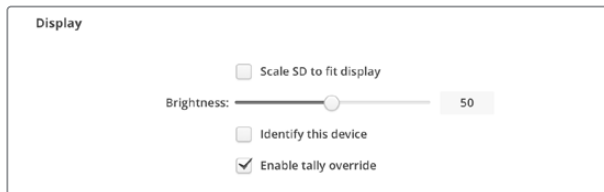

Blackmagic URSA Mini Pro 또는 URSA Broadcast 카메라와 연결된 상태에서 'Enable tally override' 확인란을 클릭하면 SmartView 4K에 탈리 보더가 나타납니다.

SmartView 4K 사용하기

Blackmagic SmartView 4K 소개

SmartView 4K는 6RU 크기의 UHD 12G-SDI 방송용 모니터로 SD, HD, 그리고 최대 2160p60의 원본 UHD 비디오를 디스플레이합니다. 밝은 디스플레이와 넓은 시야각을 제공하는 SmartView 4K는 정확한 초점 및 색상 모니터링을 위해 크리스탈처럼 선명한 영상을 지원하며 거의 모든 비디오 포맷을 지원합니다.

스튜디오 및 야외 방송 환경을 위해 제작된 SmartView 4K는 사용법이 굉장히 간단합니다. 측면에 탑재된 커넥터와 VESA 지원 기능을 통해 협소한 공간뿐 아니라 벽이나 연접식 암에 설치할 수 있습니다. SmartView 4K는 내장 컨트롤 패널에서 운영할 수 있으며 전면 패널에 접근이 불가능한 경우 이더넷 연결을 통해 원격으로 제어할 수 있습니다.

두 개의 멀티 레이트 12G-SDI 입력을 통해 두 SDI 소스 및 SMPTE 호환 SFP 모듈 소켓 중에서 선택할 수 있어, 광섬유 SDI 모듈 추가 시 광섬유로 비디오를 연결할 수 있습니다. 12G-SDI 출력을 제공해 비디오 피드를 다른 장비에 전송할 수 있을 뿐 아니라 네트워크, 원격 제어, 루프 출력을 위한 두 개의 이더넷 커넥터를 통해 다른 모니터와 데이지 체인 방식으로 연결할 수 있습니다. 다른 커넥터로는 라이브 프로덕션용 탈리 입력과 내부 소프트웨어 업데이트용 USB 포트가 있습니다.

Blackmagic SmartView Setup 소프트웨어를 사용해 .cube 확장자 형식의 표준 3D LUT이나 DaVinci Resolve에서 생성한 LUT을 로딩할 수도 있습니다. 3D LUT을 사용해 SmartView 4K를 카메라에 직접 연결하면 최종 그레이딩 작업 결과물에 최대한 가까운 클립 영상을 확인할 수 있습니다. 2단계의 포커스 피킹을 통해 샷의 포커스가 정확한지 확인할 수 있으며, AC/DC 전원 옵션을 지원해 SmartView 4K를 주전원에 연결해 사용하거나 야외 촬영 현장에서의 휴대성을 위해 외부 배터리에 연결할 수 있습니다.

SmartView 4K는 휴대용 및 스튜디오 방송용 프로덕션 디스플레이를 위한 완벽한 모니터링 솔루션으로, 비디오 영상을 SD/HD/UHD 비디오를 원본 3840x2160 픽셀 해상도로 모니터링할 수 있습니다.



참고 DC 전원 입력을 통해 외부 전원을 연결할 경우 외부 전원이 12V의 24 와트 전력 공급을 지원하는지 확인하세요.

컨트롤 패널 버튼

SmartView 4K 컨트롤 패널에는 여러개의 버튼이 탑재되어 있어 설정을 신속하게 변경 할 수 있습니다.

INPUT

이 버튼을 눌러 SmartView 4K의 두 12G-SDI 입력에 연결된 비디오 신호와 광섬유 SFP 모듈 입력 간을 이동할 수 있습니다. 입력에 연결된 비디오가 없을 경우 해당 입력이 SmartView 4K에서 검은 화면으로 나타납니다. 입력 간을 전환할 경우 연결된 입력의 포맷에 대한 정보가 모니터 좌측 하단에 잠시 동안 표시됩니다.

DISP

DISP 버튼을 사용해 SmartView 4K의 LCD 밝기를 조정할 수 있습니다. 위/아래 화살표 버튼을 사용해 밝기를 조정하세요. DISP 버튼을 다시 누르면 설정 창이 사라집니다.

H/V DELAY

H/V DELAY 버튼을 눌러 SDI 비디오 신호에 임베드된 보조 데이터를 신속하게 확인할 수 있습니다. 예를 들어, H/V DELAY 버튼을 한 번 누르면 수평 보조 데이터를 확인할 수 있습니다. H/V DELAY 버튼을 다시 한 번 누르면 폐쇄 자막과 같은 데이터에 자주 사용되는 수직 보조 데이터를 확인할 수 있습니다.

BLUE ONLY

디지털 비디오 신호에서 발생하는 노이즈의 대부분은 블루 채널 내에서 발생합니다. BLUE ONLY 버튼을 누르면 블루 채널의 노이즈를 쉽게 검사할 수 있습니다. 그러면 블루 채널 정보만 흑백으로 나타납니다. 흑백 이미지는 카메라 초점을 확인할 시에도 사용할 수 있습니다.

ZOOM

ZOOM 버튼을 사용하면 선명한 카메라 초점을 얻을 수 있습니다. 이 버튼을 한 번 누르면 영상이 확대됩니다. 이제 피사체의 초점이 잘 맞는지 제대로 확인할 수 있습니다. ZOOM 버튼을 다시 누르면 일반 크기로 되돌아갑니다.

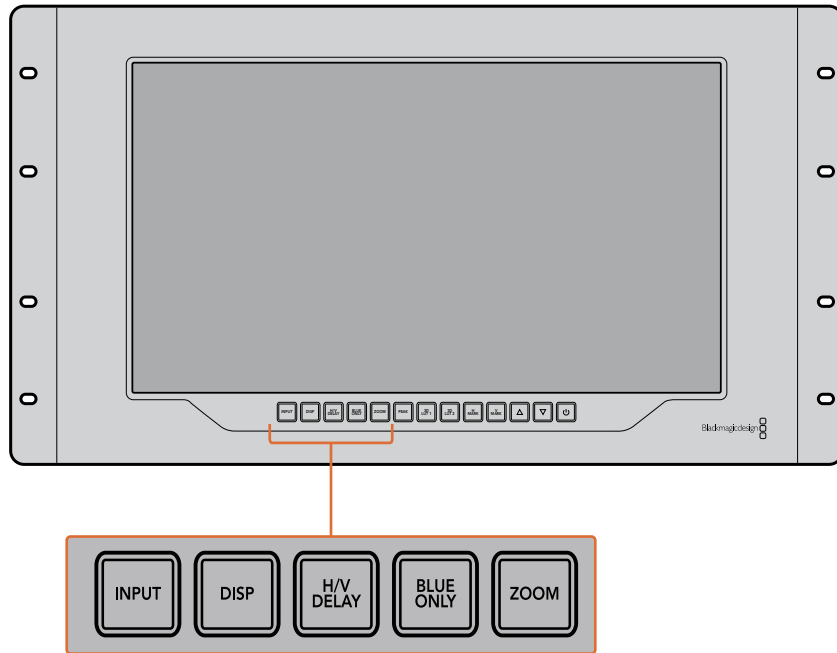

PEAK

PEAK 버튼을 눌러 포커스 피킹을 활성화하면 카메라 초점을 쉽게 확인할 수 있습니다. 이 경우 영상 속 가장 선명한 부분의 주변에 밝은 초록색 테두리가 나타납니다. PEAK 버튼을 연속해서 누르면 피킹 강도를 2단계로 조절해가며 사용할 수 있습니다. 초록색 테두리가 뚜렷하게 나타나는 것은 카메라 초점이 잘 맞춰져 있음을 뜻합니다.

3D LUT 1 및 3D LUT 2

LUT 버튼을 사용하면 Blackmagic DaVinci Resolve 또는 업계 표준 .cube LUT에서 생성된 커스텀 3D LUT 이미지를 확인할 수 있습니다. LUT을 활성화하려면 LUT 버튼을 한 번 누르세요. 버튼을 다시 한 번 누르면 LUT이 비활성화됩니다. SmartView 4K에서 3D LUT을 사용하는 방법에 대한 자세한 정보는 [Blackmagic SmartView Setup을 사용해 3D LUT 로딩하기] 섹션을 참고하세요.

H Mark 및 V Mark

H Mark 및 V Mark 버튼을 사용해 프레임 마커를 확인 및 편집할 수 있습니다. 프레임 마커를 통해 슷을 합성하거나 화면 안전 영역 내의 주요 정보 또는 그래픽을 보존할 수 있습니다. TV 모델에 따라 비디오 신호의 가장자리가 조금씩 나타나기도 하기 때문에 간편하게 안전 영역을 확인할 수 있습니다. 화면의 안전 영역은 영상 확인을 위해 사용하는 TV나 모니터 종류에 관계없이 항상 확인할 수 있는 영역입니다.

H Mark 및 V Mark 버튼을 누르면 수평 및 수직 프레임 마커가 나타납니다. 각 버튼을 다시 한 번 누르면 각 가이드에 하이라이트가 적용되어 마커를 편집할 수 있습니다. 이 경우 위/아래 화살표를 사용해 마커의 위치를 편집할 수 있습니다. 이후 각 버튼을 다시 누르면 새로운 위치 설정이 완료됩니다. 버튼을 한 번 더 누르면 마커가 사라집니다.

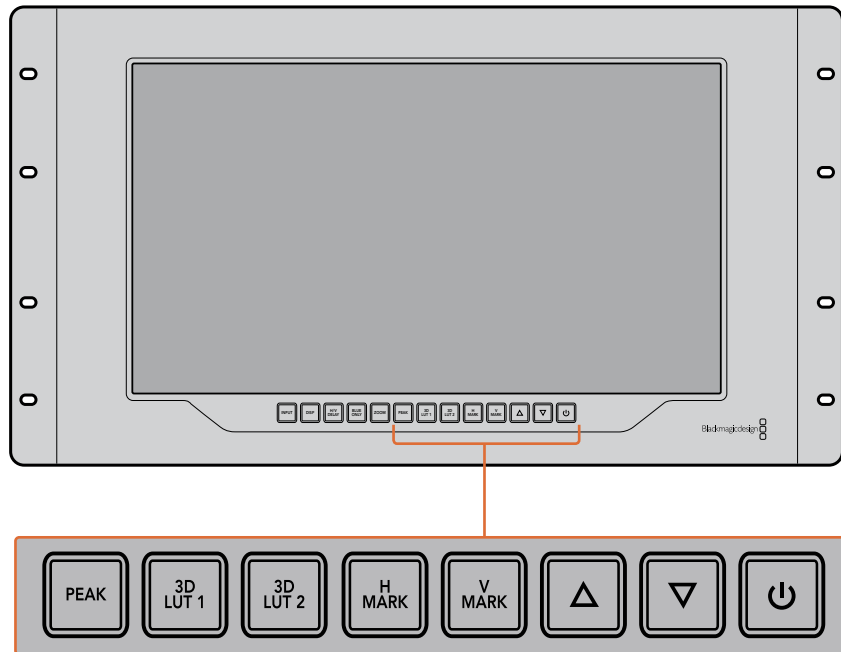

위/아래 화살표 버튼

설정 편집 시 위/아래 화살표 버튼을 사용해 디스플레이 밝기를 조정하거나 프레임 마커 위치를 편집할 수 있습니다.

전원

전원 버튼을 한 번 누르면 SmartView 4K의 전원이 켜집니다. 버튼을 한 번 더 누르면 전원이 꺼집니다.

Blackmagic SmartView Setup을 사용해 3D LUT 로딩하기

SmartView 4K에서는 3D LUT을 사용해 비디오를 모니터링할 수 있습니다. 이를 통해 전문 보정 LUT으로 SmartView 4K를 보정하거나 최종 그레이딩 작업을 마친 결과물과 가장 흡사한 영상을 확인할 수 있습니다. 3D LUT을 사용해 각기 다른 영상록을 적용해볼 수도 있습니다. Blackmagic SmartView Setup 소프트웨어를 사용해 LUT을 SmartView 4K에 로딩할 수 있습니다. SmartView 4K는 .cube 파일 확장자 형식의 업계 표준 LUT을 지원하기 때문에 Blackmagic DaVinci Resolve에서 생성된 커스텀 LUT을 로딩할 수도 있습니다. LUT 파일 생성에 관한 자세한 정보는 DaVinci Resolve 설명서를 참고하세요.

3D LUT 1에 3D LUT을 로딩하는 방법

- 1 Blackmagic SmartView Setup 소프트웨어를 실행하세요.
- 2 Load LUT 1에 있는 Load 버튼을 누르세요. 불러오려는 LUT 파일의 위치를 묻는 창이 나타납니다. 원하는 .cube LUT 파일을 선택한 뒤, Open 버튼을 누르세요.
- 3 방금 로딩한 LUT 파일을 보려면 SmartView 4K 컨트롤 패널에 있는 3D LUT 1 버튼을 누르세요. 이 버튼을 다시 누르면 LUT 기능이 해제됩니다.

같은 과정을 반복해 LUT 파일을 3D LUT 2에 로딩할 수 있습니다.

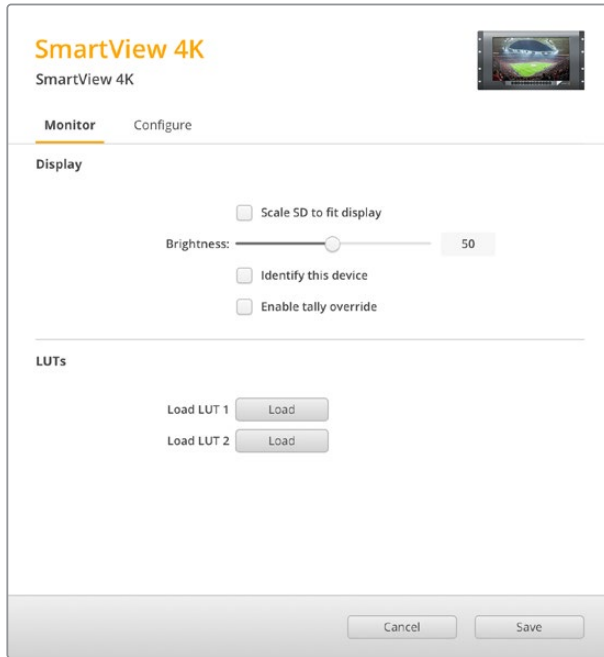

Blackmagic SmartView Setup을 사용하여 SmartView 4K에 3D LUT을 로딩하세요.

SmartScope Duo 4K 사용하기

Blackmagic SmartScope이란?

과거에는 방송 품질의 TV 스코프와 및 포스트 프로덕션 스코프는 상당히 값비싼 커스텀 솔루션이었으며 작은 스크린에서 한 번에 하나의 스코프만 볼 수 있었습니다. 일부 스코프는 미관상 보기 좋지 않아 고객에게 안 좋은 인상을 주기도 합니다.

SmartScope Duo 4K는 추가 파형 모니터를 지원해 듀얼 모니터에서 비디오 신호의 모든 부분을 실시간으로 확인할 수 있습니다. Blackmagic SmartView Setup 소프트웨어에서 입력 신호에 적용한 모든 조정 사항은 SmartScope Duo 4K에서 바로 확인할 수 있습니다. 게다가 SDI 루프 출력을 통해 각 입력 신호를 양쪽의 모니터 중 하나로 전송할 수 있습니다. 따라서 우측 모니터에는 좌측 모니터로 전송되는 신호를 위한 스코프가 나타납니다.

SmartScope Duo 4K에 나타나는 스코프는 Blackmagic SmartView Setup 소프트웨어에서 선택할 수 있습니다. Display 드롭다운 메뉴에서 스코프를 선택하세요.

아래 부분과 다음 몇 페이지에는 각 스코프 디스플레이를 사용하는 방법이 소개되어 있습니다. 이를 통해 각 디스플레이 작동법을 심도 있게 이해할 수 있습니다.



Blackmagic SmartView Setup 소프트웨어를 사용해 Blackmagic SmartScope Duo 4K의 각 모니터에 서로 다른 스코프가 나타나도록 손쉽게 설정할 수 있습니다.

비디오 모니터링(Video Monitoring) 디스플레이

비디오 모니터링(Video Monitoring) 디스플레이는 SmartScope에서 수신되는 비디오를 확인할 수 있는 간편한 컨피던스 모니터입니다.

SD 입력을 연결한 경우 Set 드롭박스 메뉴에서 종횡비를 4:3 필러박스 또는 16:9로 선택할 수 있습니다. 해당 뷰를 통해 LCD 밝기, 콘트라스트, 채도 설정에 적용된 모든 변경 사항을 바로 확인할 수 있습니다. 이러한 설정 변경은 비디오 신호가 아닌 모니터 상에서만 적용된다는 사실을 기억하세요. 따라서 채도 및 밝기 변화는 스코프에 어떠한 영향도 끼치지 않습니다.

한 모니터를 비디오 모니터링(Video Monitoring)으로, 다른 하나를 스코프 보기로 설정해 두면 아주 유용합니다. 이를 위해 짧은 케이블을 사용하여 MONITOR 1의 SD 루프 출력과 MONITOR 2의 SD 입력을 연결하세요.

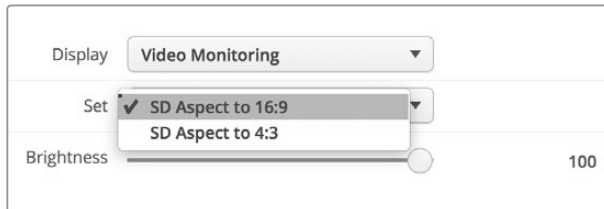

SD 비디오를 4:3 필러 박스 또는 16:9 와이드스크린으로 보려면 Blackmagic SmartView Setup 소프트웨어의 Set 항목에서 원하는 종횡비를 선택하세요. 애너모픽 SD 비디오를 모니터링할 경우 SD Aspect to 16:9로 설정하세요.

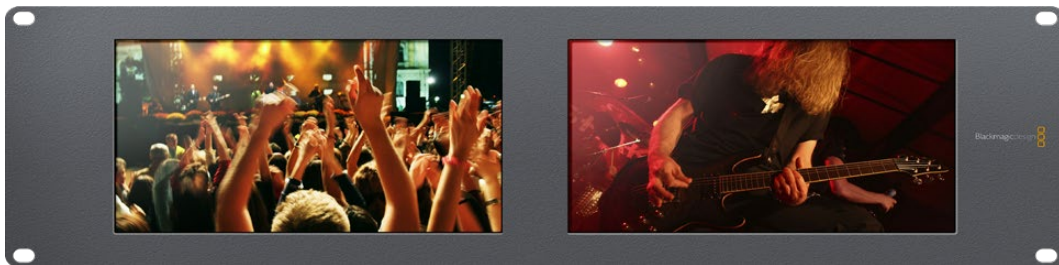

비디오 모니터링 디스플레이 설정을 통해 TV 화면이나 모니터에 나타나는 것과 동일한 비디오 신호를 볼 수 있습니다.

파형(Waveform) 디스플레이

파형 디스플레이는 일반 휘도 파형 모니터와 유사한 형태의 디지털 방식으로 인코딩된 파형을 제공합니다. 휘도 파형 모니터는 비디오 신호의 루마 또는 밝기 수준을 모니터링 및 조정하는 데 사용됩니다.

기존 휘도 파형 모니터는 콤포지트 아날로그 SD 비디오만 지원하는 반면 SmartScope Duo 4K의 파형 보기는 SD뿐만 아니라 UHD 및 HD 또한 지원하므로, HD 디지털 비디오 포맷을 모니터링할 시에도 일관된 방식으로 루마 수준을 쉽게 조절할 수 있습니다.

Blackmagic SmartView Setup 소프트웨어의 Display 드롭다운 메뉴에서 Waveform을 선택하세요. 방송 규정에 적합한 신호를 얻으려면 파형의 블랙이 0%보다 낮고 화이트가 100%를 넘지 않도록 해야 합니다.

파형 모니터는 이미지를 그래픽으로 표현한 것으로, 프레임 내의 동일 위치에 해당하는 루마 값을 시각적으로 볼 수 있습니다. 예를 들어, 영상 속 하늘의 일부가 빛에 과다 노출되면 파형 디스플레이에서 프레임의 가로 위치에 나타나는 수치를 시각적으로 확인할 수 있습니다.

파형은 영상에 따라 여러 가지 형태로 나타납니다. 콘트라스트가 높은 영상을 모니터링할 경우 미드 그레이 색상의 값이 나타나지 않을 수 있습니다. 다음 화면을 통해 빛에 고르게 노출되어 좌측의 어두운 부분과 프레임 우측의 밝은 부분이 나타난 이미지 파형을 확인할 수 있습니다.

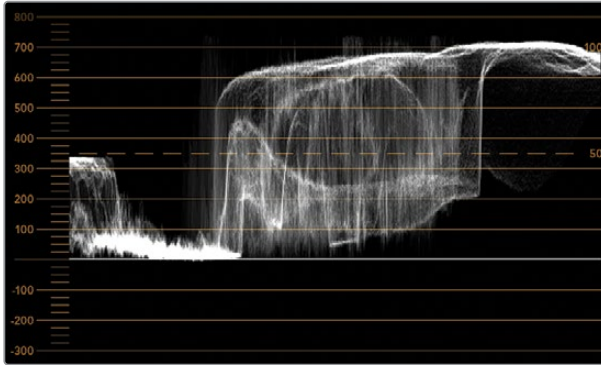

휘도 값을 보여주는 파형 디스플레이.

Adjust	<input checked="" type="radio"/> Left Monitor
	<input type="radio"/> Right Monitor
	<input type="radio"/> Both Monitors
Display	Waveform ▼
Set	No Options ▼

Blackmagic SmartView Setup 소프트웨어의 Display 항목에서 Waveform을 선택하면 비디오 신호의 루미넌스 값을 볼 수 있습니다.

벡터 스코프(Vectorscope) 디스플레이

벡터 스코프(Vectorscope) 디스플레이는 벡터 보기를 사용하여 비디오 신호의 색을 나타냅니다. 시설에서 사용하는 컬러바 테스트 신호의 표준에 따라 Blackmagic SmartView Setup 소프트웨어의 Set 드롭다운 메뉴를 100% 또는 75%로 선택하세요.

일부 사용자들은 벡터 스코프를 사용하여 방송 규정에 부적합한 수준의 색상을 확인할 수 있다고 생각하지만 이는 사실이 아닙니다. 실제로는 퍼레이드 RGB 디스플레이를 사용해 규정 색상을 확인해야 합니다. 벡터 스코프로 방송 규정에 부적합한 수준을 확인할 수 없는 이유는 크로마와 휘도값이 둘 다 필요하기 때문입니다. 예를 들어, 비디오의 색상이 화이트 및 블랙 포인트에 가깝게 나타나면 채도를 높여서 미드 그레이로 사용하는 것은 불가능합니다. 벡터 스코프 디스플레이는 휘도값을 배제한 색상만을 보여주기 때문에 이것만으로는 방송 규정 색상을 확인할 수가 없습니다.

벡터 스코프 디스플레이는 크로마 수준 조절이 필요한 구형 아날로그 비디오 테이프의 색상 수준을 확인할 때 사용하기 가장 적합한 도구입니다. 비디오 테이프의 컬러바 부분을 재생한 뒤 크로마와 휴 설정을 조절하여 눈금판에 있는 사각형 색상 상자의 비디오 색상을 설정합니다.

벡터 스코프 디스플레이는 영상의 화이트 밸런스가 정확한지 또는 색상 집중 현상이 있는지를 확인할 수 있어 컬러 그레이딩에도 적합합니다. 색상 집중 현상이 영상에서 발견되면 벡터 스코프 디스플레이는 중심에서 멀어지고 두 개의 중심점이 나타납니다. 일반적으로 비디오 신호의 블랭킹 구간은 벡터 스코프의 중심에 점으로 나타납니다. 그 이유는 비디오의 블랭킹 구간은 색상이 없는 검정 신호이기 때문입니다. 블랭킹 구간은 색상 정보가 없는 검정 신호 부분을 확인할 수 있는 기준점입니다.

비디오에 색상 집중 현상이 나타나는 경우 중심과 컬러박스에서 스코프가 멀어지는 것을 볼 수 있습니다. 중심에서 멀어진 정도가 비디오의 색상 집중 현상의 정도를 나타내어 비디오의 블랙/화이트 색상의 변화를 모두 확인할 수 있습니다. 이러한 벡터 스코프의 기능을 사용하여 색상 집중 현상을 없애고 정확한 화이트 밸런스를 유지할 수 있습니다.

벡터 스코프 디스플레이를 통해 의도하지 않은 블랙/화이트의 색상 집중 현상 없이 영상의 색상을 한계 지점까지 끌어올릴 수 있습니다. 색 균형은 RGB 퍼레이드 디스플레이와 벡터 스코프 디스플레이로 모니터링이 가능하지만 벡터 스코프 디스플레이에서 색균형의 문제점을 더욱 쉽게 확인할 수 있습니다.

특히, 얼굴 피부톤을 색보정하는 경우 따뜻한 색을 위한 채도를 유지하려면, 벡터 스코프를 10시 방향으로 조절합니다. 이러한 색은 '피부톤 라인'이라고 불리며 피부 표면에 혈색을 띠는 자연스러운 스킨 색상을 말합니다. 그러므로 피부톤 라인은 모든 피부색에 적용할 수 있으며 연기자의 피부톤을 자연스럽게 표현할 수 있는 가장 좋은 방법입니다.

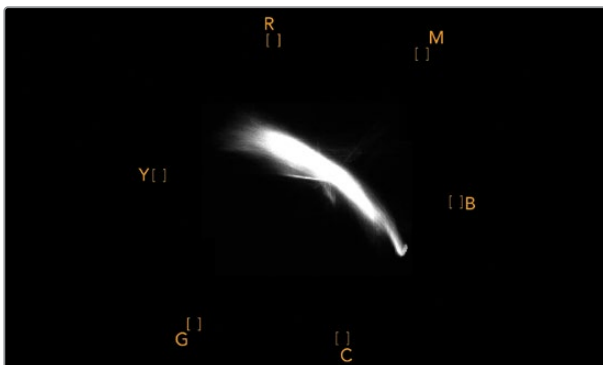

10시 방향으로 피부톤 라인을 보여주는 벡터 스코프 디스플레이.

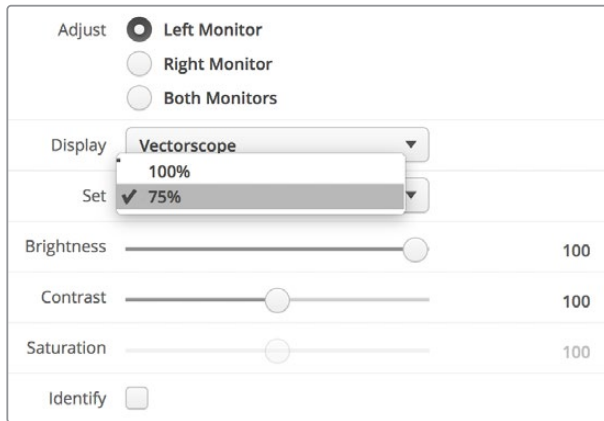

벡터 스코프를 100% 또는 75% 컬러바 테스트로 설정하세요.

퍼레이드(Parade) 디스플레이

RGB 및 YUV 퍼레이드 디스플레이는 색보정 작업과 부적절한 컬러 및 레벨 확인에 사용하기 완벽합니다.

색보정 작업 시 Blackmagic SmartView Setup 소프트웨어의 Display 드롭다운 메뉴에서 RGB Parade를 선택하세요. RGB 퍼레이드 뷰를 통해 전체 길이가 표시된 빨강, 초록, 파랑 색상의 채널이 개별적으로 표시됩니다. 각 컬러 채널의 레벨을 모니터링하여 색보정 작업을 간단히 진행할 수 있으며, 비디오의 블랙, 중간톤, 화이트 신호 색균형 또한 손쉽게 확인할 수 있습니다. RGB 퍼레이드 디스플레이를 통해 각 빨강, 초록, 파랑 채널의 디테일을 확인할 수 있어 색상 균형을 간단히 맞추고 원치 않는 색상 집중 현상을 제거할 수 있습니다.

색보정 시 비디오 레벨이 최대로 올라가되 클리핑되지 않도록 하는 것이 중요합니다. 비디오 신호 레벨을 올리고 싶은 경우 RGB 한도 범위를 넘거나 방송 규정 수준을 넘지 않도록 주의하세요. 규정 수준인 100% RGB 레벨을 넘지 않는 기기가 있지만 그렇지 않은 기기도 있습니다. SmartScope Duo 4K를 통해 방송 규정 수준을 넘을 때마다 이를 즉시 확인할 수 있습니다.

규정상 부적절한 비디오 레벨은 블랙 및 화이트 레벨에서도 나타날 수 있습니다. 일부 색보정 시스템에서는 블랙 포인트 0%이하의 블랙 레벨이 생성될 수도 있습니다. 규정상 부적절한 블랙 레벨을 발견할 시, Lift 또는 Gain의 값을 조절해 이를 제거할 수 있습니다. 이때 100% 눈금 레벨을 확인하여 전체 비디오 신호가 규정 수준을 넘거나 부적절한 화이트 신호가 발생하지 않도록 주의하세요.

YUV 레벨을 확인하려면 Display 드롭다운 메뉴에서 YUV Parade를 선택하세요. 이 뷰는 TV 방송용 비디오 신호 형식이며 루마(밝기) 값이 크로마(컬러) 값으로부터 분리되어 표시되기 때문에 유용합니다. 좌측 파형에는 루마 정보가 표시되며 두 번째 및 세 번째 파형에는 크로마 정보가 표시됩니다. YUV 퍼레이드 뷰는 비디오 신호의 크로마 값을 컬러바 테스트 패턴으로 조정하는데 유용합니다. 이를 통해 색상을 정확하게 나타낼 수 있으며 TV 세트에서 디스플레이할 수 있는 방송 신호를 얻을 수 있습니다.

색보정 작업은 방송 규정상 허용되는 범위에서 최고의 영상 이미지를 얻기 위해 영상을 지속적으로 조정하는 과정입니다.

색보정 용어

블랙 - 비디오 신호의 블랙 레벨

미드톤 - 비디오 신호의 미드 그레이 레벨

화이트 - 비디오 신호의 화이트 레벨

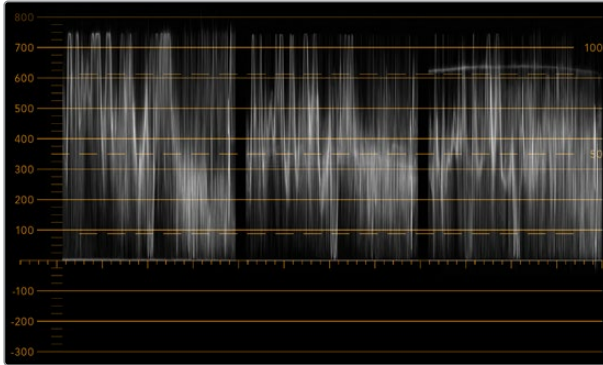

RGB 퍼레이드 뷰

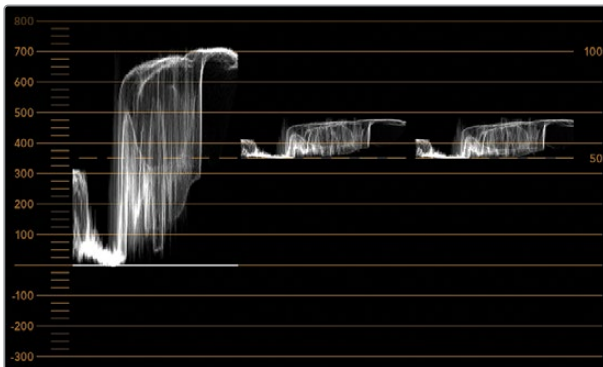

YUV 퍼레이드 뷰

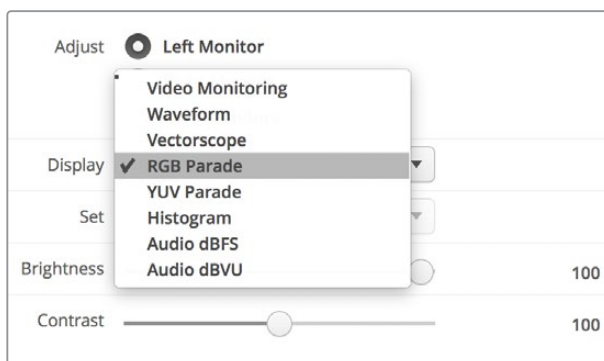

Blackmagic SmartView Setup 소프트웨어의 Display 드롭다운 메뉴에서 RGB Parade 및 YUV Parade를 선택하세요.

히스토그램(Histogram) 디스플레이

히스토그램 디스플레이는 그래픽 디자이너와 카메라 운영자에게 가장 익숙한 디스플레이입니다. 히스토그램 디스플레이는 화이트에서 블랙까지의 색상 분포 정보를 보여주며 비디오의 화이트 및 블랙 정보의 클리핑 여부를 모니터링할 수 있습니다. 히스토그램 디스플레이는 비디오에 적용된 감마 효과를 보여줍니다.

블랙 비디오는 디스플레이 왼쪽에 그리고 화이트 비디오는 오른쪽에 나타납니다. 일반적으로 모든 비디오는 히스토그램 디스플레이의 0%와 100%사이에 나타납니다. 비디오가 0%미만이거나 100%를 초과하면 클리핑된 것을 의미합니다. 촬영 중에 비디오 클리핑 현상이 발생하면 곤란할 수 있습니다. 왜냐하면, 블랙/화이트의 디테일을 보존해야 나중에 통제된 환경에서 색보정 작업을 수행할 수 있기 때문입니다. 촬영 시 비디오를 0%이상의 블랙 클리핑 범위와 화이트 클리핑 범위 안으로 제한하면 나중에 더욱 자유롭게 색조정 작업을 할 수 있습니다.

색보정 중에 비디오를 클리핑해야 하는 경우가 생길 수도 있습니다. 이러한 경우에 히스토그램 디스플레이에서 비디오의 클리핑 효과를 보고 얼마나 클리핑 되었는지를 확인할 수 있습니다. 약간의 클리핑 효과로 더 많은 디테일을 유지한 채 감마를 사용하면 비슷한 장면을 연출할 수 있습니다.

히스토그램 디스플레이를 통해 부적절한 블랙/화이트는 확인이 가능하지만, 방송 규정에 부적합한 수준을 확인할 수는 없습니다. 히스토그램 디스플레이는 색상을 나타내지 않기 때문에 비디오에 포함된 부적절한 색상도 규정 범위 내의 수준으로 나타날 수가 있습니다. RGB 퍼레이드 디스플레이는 비디오 신호의 색상과 휘도를 모두 보여주기 때문에 방송 규정 수준을 확인하기에 가장 적합합니다.

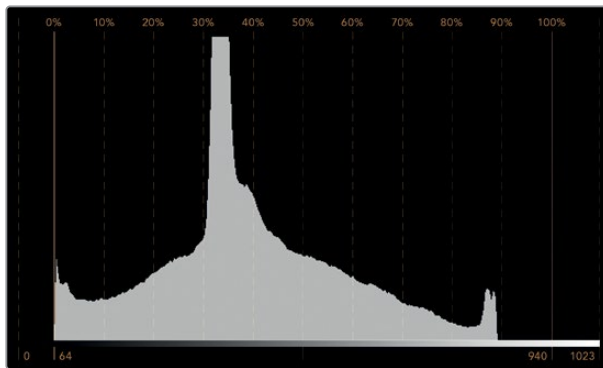

화이트 및 블랙의 분포 정도를 보여주는 히스토그램 디스플레이 설정

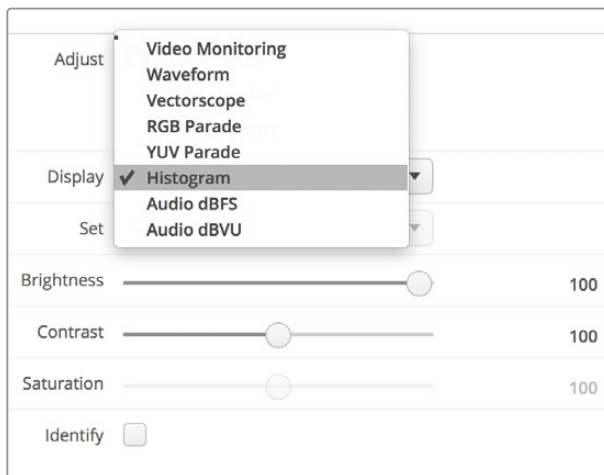

Blackmagic SmartView Setup 소프트웨어의 Display 드롭다운 메뉴에서 Histogram을 선택하세요.

오디오 미터링 표시

오디오 미터링 표시는 SDI 비디오 신호에 임베드된 오디오 수준을 나타냅니다. 최대 16채널의 임베디드 오디오가 디임베드되어 dBVU 또는 dBFS 형식으로 표시됩니다.

신호의 평균 레벨을 나타내는 VU 미터는 사용이 편리하며 오래된 장비에서 주로 사용됩니다. VU는 SMPTE 권장 신호인 -20 dBFS로 설정된 1 kHz 톤의 테스트 신호를 사용합니다.

dBFS는 본래 전체 디지털 오디오 신호를 측정하기 위한 단위로서 현대 디지털 기기에서 흔히 사용됩니다.

우측 오디오 스코프에서 2개의 오디오 채널을 모니터링할 수 있습니다. 해당 채널은 Set 드롭다운 메뉴에서 선택할 수 있습니다. 예) 채널 1 & 2 또는 채널 3 & 4 등. 오디오 스코프는 X/Y축에 오디오를 나타내므로 오디오 밸런스 문제 및 위상 상태를 확인할 수 있고 오디오 트랙이 모노인지 또는 스테레오인지를 확인할 수 있습니다. 모노 오디오인 경우 하나의 수직선 In Phase 라인으로 나타납니다. 이 라인이 수평으로 나타나면 오디오가 '위상 반전' 상태임을 나타내며, 다운스트림 장비에서 신호를 전송받을 시 오디오 손실과 같은 현상이 나타날 수 있습니다. 오디오 위상은 대형 시설에서 케이블이 제대로 연결되어 있지 않은 경우 가장 흔히 일어나는 오디오 결함 중 하나입니다.

스테레오 신호를 모니터링할 시에는 우측 오디오 스코프에서 신호 표시가 좌/우 오디오 채널의 차이에 따라 퍼져서 나타납니다. 오디오 트랙의 스테레오 사운드가 더욱 많을수록 신호 표시가 더욱 둥글게 나타납니다. 오디오에 스테레오 콘텐츠가 적게 포함되어 있을수록 신호 표시는 수직선 주위에 더욱 집중됩니다.

다이얼로그 오디오는 수직 라인으로 나타나는 경향이 있는 반면, 스테레오 콘텐츠가 많이 포함된 음악은 스코프가 불룩하게 부풀어 나타납니다. 그 이유는 모노 오디오가 L+R이고 수직축에 나타나는 반면, 스테레오 콘텐츠는 L-R이며 가로축에 나타나 스테레오 간의 차이를 보여주기 때문입니다.

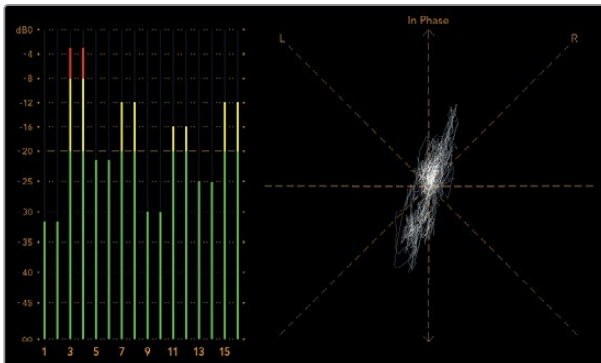

피크 레벨 및 오디오 밸런스를 보여주는 오디오 미터링 디스플레이.

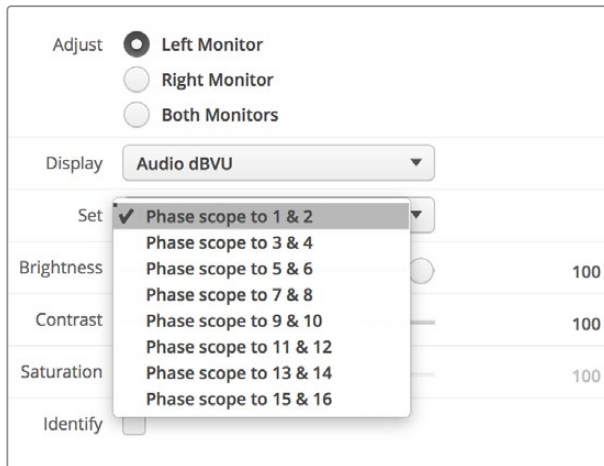

Set 드롭다운 메뉴에서 모니터링할 오디오 채널 조합을 선택하세요.

네트워크에 연결하기

SmartView 또는 SmartScope 모니터를 네트워크에 연결해 여러 유닛의 모니터 설정을 원격으로 조정할 수 있습니다.

SmartView 및 SmartScope 모니터에서는 어떠한 환경 설정 없이도 비디오를 디스플레이할 수 있지만, 유닛을 배치하기 전에 네트워크 환경을 설정해야 합니다. 네트워크 환경 설정 작업은 컴퓨터에 직접 연결된 USB를 통해서만 가능합니다.

다이렉트 이더넷

컴퓨터에 연결된 다이렉트 이더넷 연결을 통해 모니터 환경을 원격으로 설정할 수 있습니다. 해당 환경 설정엔 네트워크 스위치가 따로 필요 없기 때문에 신속한 설치 및 설정이 필요한 상황에 유용합니다. 각 유닛의 액티브 루프스루 이더넷 출력 포트를 사용해 추가 유닛을 데이지 체인 방식으로 연결할 수 있습니다. 데이지 체인 방식으로 연결된 모든 유닛의 전원을 반드시 연결하세요.

기존 스튜디오 네트워크의 IP 주소를 사용하지 않고 여러 대의 유닛을 연결하고자 하거나 기존 네트워크가 없는 경우에는 간단히 컴퓨터 이더넷 포트에 직접 연결하세요. 네트워크 스위치 연결용 케이블을 따로 사용할 필요가 없기 때문에 이더넷을 통해 SmartView 및 SmartScope 유닛을 신속하게 연결할 수 있습니다.

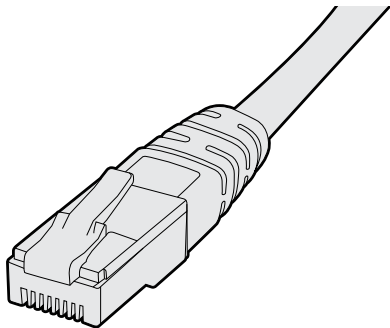

이더넷 커넥터

이더넷 네트워크 스위치

스튜디오 네트워크에 여러 대의 유닛을 연결하고자 할 경우 한 대의 SmartView 또는 SmartScope를 네트워크 스위치에 연결한 다음 각 유닛의 액티브 루프스루 이더넷 출력 포트를 통해 나머지 유닛을 데이지 체인 방식으로 간단히 연결할 수 있기 때문에 스위치에 있는 포트는 하나만 사용하면 됩니다. 덕분에 네트워크 스위치 뒷면에 여러 개의 케이블을 연결할 필요가 없습니다. 단, 데이지 체인 방식으로 연결된 모든 유닛의 전원을 연결해야 작동합니다.

네트워크 스위치에 연결하면 네트워크 상의 모든 컴퓨터를 통해 유닛 설정을 변경할 수 있습니다. 네트워크에 무선 중계 장치(AP)가 설치되어 있는 경우 모든 Mac 또는 Windows 노트북 컴퓨터에서도 WiFi 연결을 통해 설정을 변경할 수 있습니다.

SmartView 또는 SmartScope를 인근 IP 기반 네트워크에 연결하려면 다음 단계를 따르세요.

- 1 제품에 포함된 전원 공급 장치를 안전하게 연결한 다음 전원을 켜세요.
- 2 표준 RJ45 이더넷 케이블로 유닛과 스위치를 연결하거나 컴퓨터에 직접 연결합니다.

다이렉트 이더넷 연결 도면

네트워크 스위치를 사용하지 않고도 컴퓨터의 이더넷 포트를 유닛에 직접 연결할 수 있습니다. 추가 유닛을 데이지 체인 방식으로 서로 연결할 수 있어 네트워크 스위치 뒤에 여러 개의 케이블을 연결할 필요가 없습니다. 단, 모든 유닛의 전원을 반드시 연결하세요.

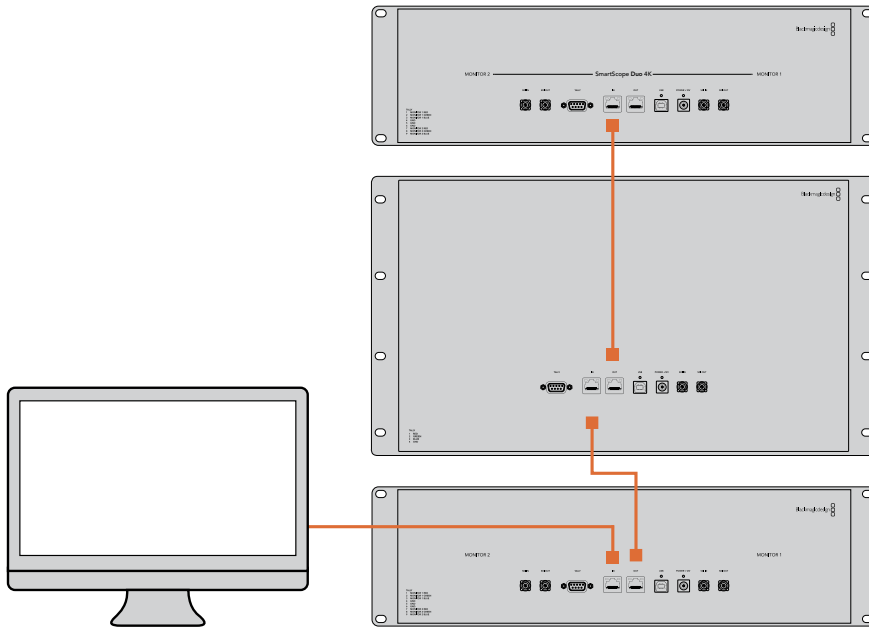

이더넷 네트워크 스위치 연결 도면

스튜디오의 기존 네트워크에 여러 대의 유닛을 연결하고자 할 경우엔 유닛 한 대만 네트워크 스위치에 연결하면 됩니다. 나머지 유닛을 데이지 체인 방식으로 서로 연결할 수 있어 네트워크 스위치 뒤에 여러 개의 케이블을 연결할 필요가 없습니다. 단, 모든 유닛의 전원을 반드시 연결하세요.

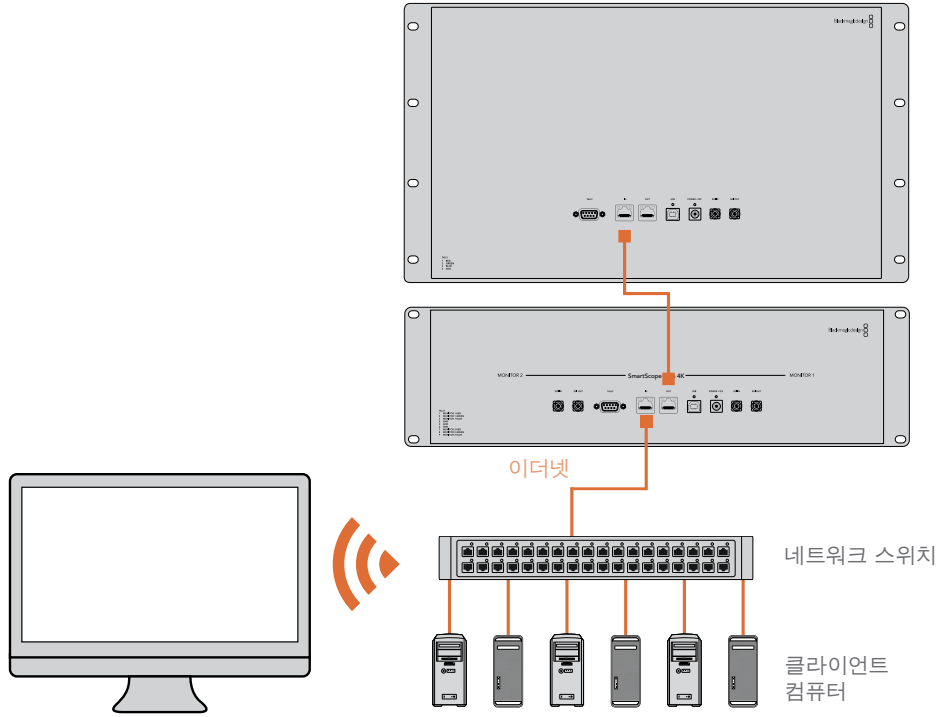

네트워크 설정 조정하기

네트워크 설정

장치명

네트워크 상에서 각 SmartView 또는 SmartScope 유닛을 쉽게 확인할 수 있도록 모니터 이름을 변경하는 것이 좋습니다. 예) Field Cameras 1 & 2, Multi-View Output, 4K feeds 등.

모니터 이름을 변경하려면 먼저 모니터가 이더넷 또는 USB를 통해 연결되어 있는지 확인하세요. Blackmagic SmartView Setup 소프트웨어를 실행한 뒤, 모니터 이름 아래쪽에 있는 설정 아이콘을 클릭하세요. 설정 페이지에서 Network를 클릭한 다음 Details 섹션에서 모니터 이름을 변경하세요. 소프트웨어에서 올바르게 입력된 이름이 감지될 경우 모니터 이름 옆에 경고 아이콘이 나타납니다. 적합한 이름일 경우 녹색 체크 표시가 나타납니다. 컴퓨터 키보드의 return 키를 누르면 이름 변경이 완료됩니다.

네트워크 설정

Blackmagic SmartView Setup 소프트웨어의 Network Settings 섹션을 변경하려면, Blackmagic 모니터와 컴퓨터를 USB로 연결해야 합니다. 이더넷 연결로는 네트워크 설정을 변경할 수 없습니다.

SmartView와 SmartScope에서는 DHCP를 사용해 네트워크에서 IP 주소를 자동으로 얻을 수 있도록 기본 설정되어 있습니다.

DHCP 서버가 없는 상황에서는 macOS의 인터넷 공유 기능이나 Windows 8.1 및 Windows 10의 인터넷 연결 공유(ICS) 기능을 활성화해 DHCP 주소를 직접 연결된 모든 유닛에 제공할 수 있습니다. 그러면 고정 IP 주소를 각 유닛마다 수동으로 지정할 필요가 없습니다. 이 기능을 사용하면 컴퓨터가 인터넷에 연결되어 있지 않은 상황에서도 DHCP 주소를 제공할 수 있습니다. 인터넷 공유에 대한 자세한 정보는 macOS와 Windows 8.1/10의 도움말 문서를 참고하세요.

환경 설정에서 DHCP를 사용할 수 없는 경우, 고정 IP를 사용해 주소를 설정할 수 있습니다. 네트워크에서 IP 충돌이 일어나지 않도록 시스템 관리자에게 다른 IP 주소를 요청세요. 일반 서브넷 마스크뿐만 아니라 각 SmartView 및 SmartScope 유닛의 고유 IP 주소를 반드시 명시해야 합니다. 유닛을 인터넷 라우터와 같은 네트워크 게이트웨이에 연결하고자 하는 경우가 아니라면 Gateway 필드에 있는 기본 설정값을 따로 변경할 필요가 없습니다.

네트워크에 SmartView 및 SmartScope 모니터가 나타나지 않는다면 이는 DHCP를 통해 유닛으로 IP 주소가 전달되지 않았기 때문일 수 있습니다. 이런 경우엔 각 유닛의 네트워크 설정을 수동으로 적절히 조정해야 합니다.

- 1 USB를 사용해 Blackmagic SmartView 또는 SmartScope 모니터와 컴퓨터를 연결한 다음 Blackmagic MultiView Setup 소프트웨어를 실행하세요.
- 2 SmartView Setup 소프트웨어 시작 화면에 연결된 모니터가 자동으로 나타나며, 장비 이름 옆에 USB 아이콘이 나타납니다.
- 3 모니터의 네트워크 설정을 조정하세요.
- 4 DHCP를 통해 IP 주소를 받지 못한 다른 유닛에서도 이 단계를 반복하세요.

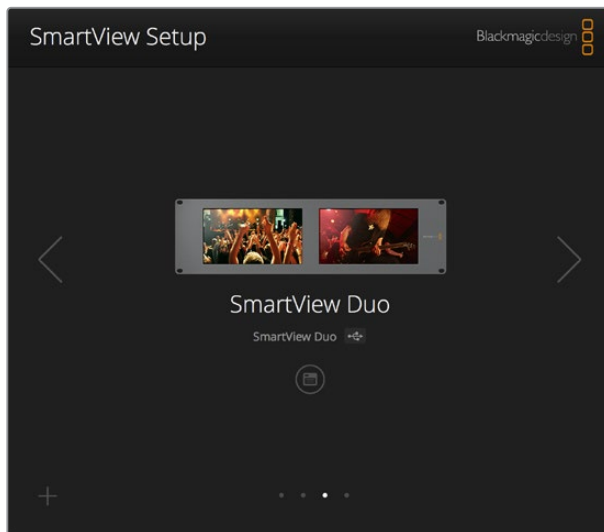

모니터 이름 옆에 나타난 USB 아이콘을 통해 모니터와 컴퓨터가 USB로 연결되었음을 확인할 수 있습니다. 네트워크 설정을 조정하려면 Blackmagic 모니터를 USB로 연결하세요.

Monitor	Configure
Details	
Name:	SmartView Duo
Software Version:	4.0.1
Network Settings	
IP setting:	<input type="radio"/> DHCP <input checked="" type="radio"/> Static IP
IP Address:	192.168.10.42 ✔
Subnet Mask:	255.255.255.0
Gateway:	192.168.10.1
<input type="button" value="Cancel"/> <input type="button" value="Save"/>	

네트워크 설정은 DHCP 또는 Static IP로 설정할 수 있으며 오직 USB를 통해서만 변경할 수 있습니다.

Blackmagic 모니터 추가하기

SmartView 또는 SmartScope Duo 4K의 IP 주소를 이미 알고 있지만 SmartView Setup 소프트웨어 시작 화면에 자동으로 나타나지 않을 경우 모니터를 수동으로 추가할 수 있습니다. 다음 순서에 따라 업데이트를 진행하세요.

- 1 Blackmagic 모니터가 이더넷을 통해 연결되어 있는지 확인하세요. 좌측 하단에 있는 + 아이콘을 클릭하면 Add a Blackmagic Monitor라는 창이 나타납니다.
- 2 모니터의 IP 주소를 입력한 뒤, Add 버튼을 클릭하세요.
- 3 소프트웨어에서 유닛을 인식하고 나면 SmartView Setup 시작 화면의 Blackmagic 모니터에 해당 유닛이 추가됩니다. 오른쪽 화살표 아이콘을 클릭하여 새롭게 추가된 모니터를 볼 수 있습니다.

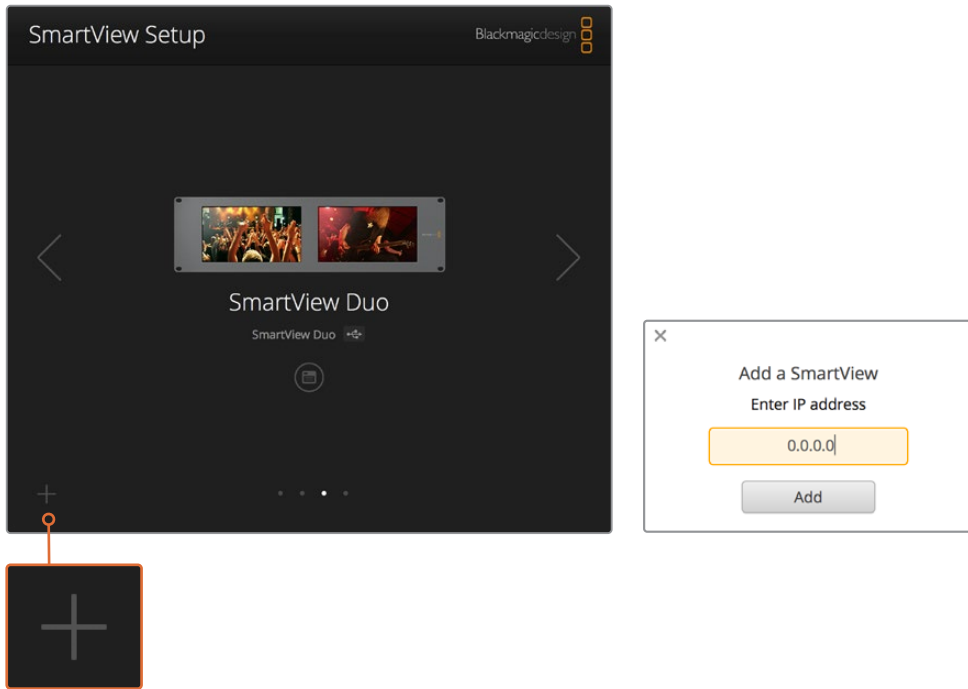

+ 아이콘을 클릭한 뒤 모니터의 IP 주소를 입력해 SmartView 또는 SmartScope 모니터를 연결된 모니터 목록에 수동으로 추가할 수 있습니다.

탈리 사용

탈리 포트 핀 연결

SmartView 또는 SmartScope의 탈리 포트를 반드시 연결할 필요는 없습니다. 탈리 기능을 사용하지 않을 경우엔 이 단계를 건너뛸 수 있습니다.

각 SmartView 또는 SmartScope 화면에는 빨간색/녹색/파란색의 개별 탈리 보더가 나타나 현재 비디오 신호가 방송 중, 미리보기, 녹화 중임을 알 수 있습니다.

9핀 D-Sub 탈리 포트를 통해 스위처 및 자동화 시스템의 접점 폐쇄 신호를 연결할 수 있습니다. 탈리 포트를 스위처 및 자동화 시스템과 함께 사용하기 위한 배선 관련 정보는 첨부된 탈리 핀 연결 배선 도면을 참고하세요.

9핀 D-Sub 포트 배선 관련 상세 정보는 제품 뒷면에 프린트되어 있습니다. 이를 통해 개별 모니터에 빨간색/녹색/파란색 탈리 보더가 나타나게 하는 접점 폐쇄 관련 정보를 확인할 수 있습니다.

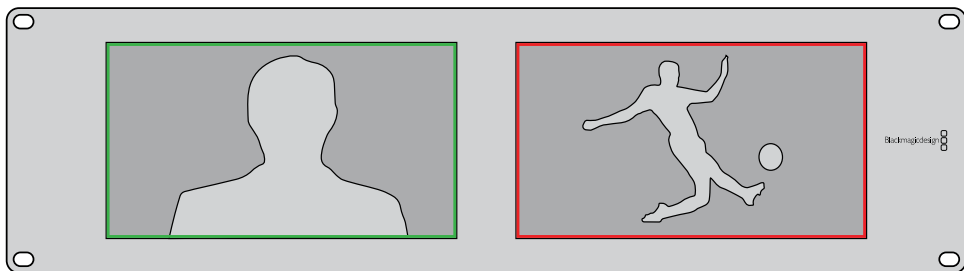

SmartView Duo에 나타난 녹색 및 빨간색 탈리 보더

SmartView Duo 및 SmartScope Duo 4K 탈리 핀 연결	
핀	기능
1	모니터 1 빨간색
2	모니터 1 녹색
3	모니터 1 파란색
4	접지
5	접지
6	접지
7	모니터 2 빨간색
8	모니터 2 녹색
9	모니터 2 파란색

SmartView 탈리 포트

SmartView HD 및 SmartView 4K 탈리 핀 연결	
핀	기능
1	빨간색
2	초록색
3	파란색
4	접지

시야각 최적화하기

SmartView Duo, SmartView HD 또는 SmartScope 모니터를 장비랙의 높은 곳에 설치해야 할 경우 최적의 시야각을 위해 LCD 화면을 거꾸로 설치할 수도 있습니다. 거꾸로 설치된 것이 감지될 경우 LCD 이미지가 자동으로 회전됩니다. 전면판을 뒤쪽 어셈블리로부터 분리하거나 재조립할 경우 02 크기의 Pozidriv 드라이버가 필요합니다. 이는 뒷면 어셈블리를 분해할 필요가 없는 아주 간단한 과정입니다.

다음은 전면판에 있는 Blackmagic Design 로고를 올바른 방향으로 유지한 채 유닛을 거꾸로 설치하는 방법에 대한 설명입니다. 02 크기의 Pozidriv 드라이버가 필요합니다.

- 1 전면판 상/하/좌/우에 있는 나사를 분리하세요. SmartView Duo와 SmartScope Duo 4K에는 10개의 나사가, SmartView HD에는 18개의 나사가 있습니다.
- 2 아래 그림에 나온 것처럼 전면판을 뒷면 어셈블리로부터 떼어냅니다.
- 3 위아래가 바뀌도록 뒷면 어셈블리를 회전시키세요.
- 4 거꾸로 뒤집은 뒷면 어셈블리에 전면판을 재조립합니다.
- 5 새시에 나사를 다시 고정하세요.

이제 SmartView 또는 SmartScope를 장비랙 높은 곳에 설치할 준비가 완료되었습니다. 장비랙에 고정하고 나면 SmartView에 충격이 가해지더라도 잘못 눌러지거나 느슨해질 만한 외부 노브 또는 조절 장치가 없기 때문에 언제나 최적의 시야각을 제공합니다.



유닛을 장비랙 높은 곳에 고정하기 전에 화면 회전 기능을 테스트해 보는 것이 좋습니다.

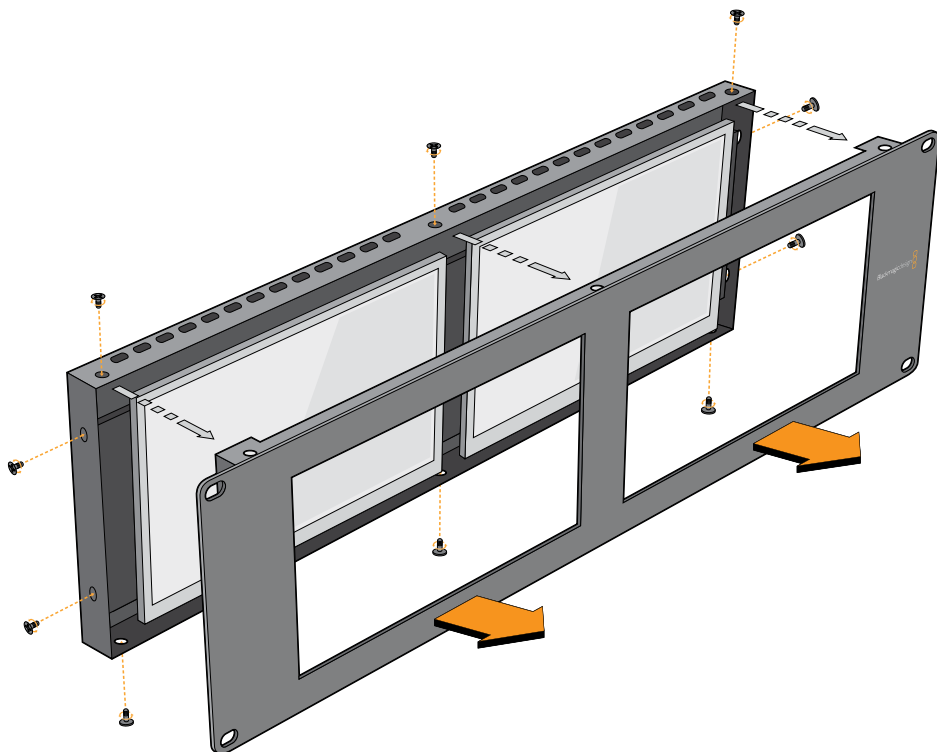

나사를 모두 제거한 다음 전면판을 뒷면 어셈블리로부터 떼어냅니다.

Developer Information

Developing Custom Software Using Blackmagic Design Hardware

The Blackmagic SmartView Ethernet Protocol allows developers to remotely control Blackmagic SmartView and SmartScope hardware with their own custom software. The Blackmagic SmartView Ethernet Protocol is a text-based status and control protocol.

Downloading the Free SmartView Ethernet Protocol

The Blackmagic SmartView Ethernet Protocol is free. It is included in this SmartView & SmartScope manual and can be downloaded from www.blackmagicdesign.com/kr/support

Joining the Blackmagic Design Developer List

The Blackmagic Developer mailing list is designed for technical questions regarding technologies used by Blackmagic Design, e.g., QuickTime, Core Media, DirectShow, codecs, APIs, SDKs, etc. The free mailing list is a forum where developers can discuss ideas and problems with other developers. Any subscriber may reply and the Blackmagic Design engineers may also respond when appropriate. You can subscribe to the mailing list at: <http://lists.blackmagicdesign.com/mailman/listinfo/bmd-developer>

In some cases, we might request a brief outline of the software you are developing if it is not immediately obvious from your domain name that your organization develops video software. Please don't take offence as we're simply trying to keep the list free of spam and viruses as well as end-user customers asking non-development questions, employment agents or sales people trying to promote products on the list. The list is just for developers.

Contacting Blackmagic Design Developer Assistance

You can also contact us via developer@blackmagicdesign.com if you have any developer related questions or wish to ask questions off the list.



Blackmagic 2K Format – Overview

Blackmagic Design products support 3G-SDI video, which allows twice the data rate of traditional HD-SDI video. We thought it would be a really nice idea to add 2K film support, via 3G-SDI technology, so we could simplify feature film workflows. With the popularity of Blackmagic Design editing systems worldwide, now thousands of people can benefit from a feature film workflow revolution.

This information includes everything product developers need to know for building native 2K SDI equipment. Of course, all Blackmagic products can be updated, so if the television industry adopts an alternative SDI-based film standard, we can add support for that too!

Frame Structure

- Transmitted at 23.98, 24 or 25 frames per second as a Progressive Segmented Frame.
- Active video is 2048 pixels wide by 1556 lines deep.
- Total lines per frame : 1650
- Active words per line are 1535. One word consists of a 10-bit sample for each of the four data streams, i.e., a total of 40 bits. See the diagram named Blackmagic 2K Format - Data Stream Format.
- Total active lines : 1556
- Total words per line : 1875 for 23.98/24Hz and 1800 for 25Hz.
- Fields per frame : 2, 825 lines each
- Active lines located on lines 16-793 (field 1) and 841-1618 (field 2).

Transport Structure

- Based on SMPTE 372M Dual Link mapping and SMPTE 425M-B support for mapping SMPTE 372M into a single 3 Gb/s link.
- Timing reference signals, line number and line CRC insertion is the same as above.
- During active video, 10-bit Red, Green and Blue data is sent in the following sequence:
- Optional ancillary data is inserted into both virtual interfaces.
- At present, only audio data is included: as per standard HD audio insertion (SMPTE S299M) the audio data packets are carried on data stream two and audio control packets are carried on data stream one.
 - Data stream 1: Green_1, Green_2, Green_3, Green_5...Green_2047
 - Data stream 2: Blue_1, Blue_2, Green_4, Blue_5...Green_2048.
 - Data stream 3: Red_1, Blue_3, Blue_4, Red_5...Blue_2048.
 - Data stream 4: Red_2, Red_3, Red_4, Red_6...Red_2048.

Blackmagic 2K Format – Vertical Timing Reference

This diagram shows the vertical timing details with line numbers and Field, Vertical and Horizontal bits for the Timing Reference Signal codes.

		Field 1					Active					
F	1	0	0	0	0	0	0	0	0	0	0	0
V	1	1	1	1	1	1	0	0	0	0	1	1
LINE #	1650	1	2	...	14	15	16	...	792	793	...	825

		Field 2					Active					
F	0	1	1	1	1	1	1	1	1	1	1	1
V	1	1	1	1	1	1	0	0	0	0	1	1
LINE #	825	826	827	...	839	840	841	...	1617	1618	...	1650

Blackmagic 2K Format – Data Stream Format

This diagram shows the data stream formats around the optional ancillary data section of the horizontal line. Note that each active pixel takes up three samples.

Word# 25 PsF	Word# 23.98/24 PsF	Data Stream 4	Data Stream 3	Data Stream 2	Data Stream 1
1795	1870	R2042	R2041	B2041	G2041
1796	1871	R2043	B2043	B2042	G2042
1797	1872	R2044	B2044	G2044	G2043
1798	1873	R2046	R2045	B2045	G2045
1799	1874	R2047	B2047	B2046	G2046
1800	1875	R2048	B2048	G2048	G2047
1	1	EAV(3FFh)	EAV(3FFh)	EAV(3FFh)	EAV(3FFh)
2	2	EAV(000h)	EAV(000h)	EAV(000h)	EAV(000h)
3	3	EAV(000h)	EAV(000h)	EAV(000h)	EAV(000h)
4	4	EAV(XYZh)	EAV(XYZh)	EAV(XYZh)	EAV(XYZh)
5	5	LN0	LN0	LN0	LN0
6	6	LN1	LN1	LN1	LN1
7	7	CRC0	CRC0	CRC0	CRC0
8	8	CRC1	CRC1	CRC1	CRC1
9	9	200	040	ANC/Audio Data	ANC/Audio Data
...		
260	335	200	040		
261	336	SAV(3FFh)	SAV(3FFh)	SAV(3FFh)	SAV(3FFh)
262	337	SAV(000h)	SAV(000h)	SAV(000h)	SAV(000h)
263	338	SAV(000h)	SAV(000h)	SAV(000h)	SAV(000h)
264	339	SAV(XYZh)	SAV(XYZh)	SAV(XYZh)	SAV(XYZh)
265	340	R2	R1	B1	G1
266	341	R3	B3	B2	G2
267	342	R4	B4	G4	G3
268	343	R6	R5	B5	G5

Blackmagic SmartView Ethernet Protocol v1.3

Summary

The Blackmagic SmartView Ethernet Protocol is a text-based status and control protocol, very similar in structure to the Videohub protocol, that is accessed by connecting to TCP port 9992 on a SmartView or SmartScope device.

Upon connection, the SmartView or SmartScope device sends a complete dump of the state of the device. After the initial dump, state changes are sent asynchronously.

The device sends information in blocks which have an identifying header, followed by a colon. A block can span multiple lines and is terminated by a blank line.

To be resilient to future protocol changes, clients should ignore blocks they do not recognize, up to the trailing blank line. Within recognized blocks, clients should ignore lines they do not recognize.

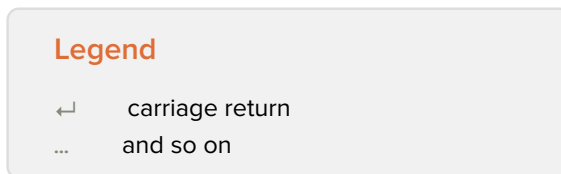

Version 1.3 of the Blackmagic SmartView Ethernet Protocol was released with SmartView 1.3 software.

Protocol Preamble

The first block sent by the SmartView Server is always the protocol preamble:

```
PROTOCOL PREAMBLE:↵
Version: 1.3 ↵
↵
```

The version field indicates the protocol version. When the protocol is changed in a compatible way, the minor version number will be updated. If incompatible changes are made, the major version number will be updated.

Device Information

The next block contains general information about the connected SmartView or SmartScope device.

```
SMARTVIEW DEVICE:↵
Model: SmartView Duo↵
Hostname: stagefront.studio.example.com↵
Name: StageFront↵
Monitors: 2↵
Inverted: false↵
↵
```

This example shows the output for a SmartView Duo device, which has two LCDs. The INVERTED flag indicates whether the device has detected that it has been mounted in an inverted configuration to optimize LCD viewing angle.

Network Configuration

The next block shows the TCP/IP networking configuration:

```
NETWORK:↵  
Dynamic IP: true↵  
Static address: 192.168.2.2↵  
Static netmask: 255.255.255.0↵  
Static gateway: 192.168.2.1↵  
Current address: 192.168.1.101↵  
Current netmask: 255.255.255.0↵  
Current gateway: 192.168.1.1↵  
↵
```

The network settings prefixed with CURRENT show the active TCP/IP settings, and are read-only. The CURRENT settings reflect either the DHCP or Static configuration, depending on the DYNAMIC IP flag.

Changing Networking Settings

The network can be configured to use either DHCP or a static configuration. To enable DHCP:

```
NETWORK:↵  
Dynamic IP: true↵  
↵
```

To set a fixed IP address, supply all static parameters, thus:

```
NETWORK:↵  
Dynamic IP: false↵  
Static address: 192.168.2.2↵  
Static netmask: 255.255.255.0↵  
Static gateway: 192.168.2.1↵  
↵
```

The parameters with the CURRENT prefix are read-only, and show the active configuration, regardless of the static or dynamic setting.

Changing the device name, or any network settings, will cause the IP connection to be dropped. The device will restart its networking and advertise its new name on the network.

Changing Monitor Settings

The display settings for each monitor are specified individually. One or more parameters can be modified at the same time and multiple settings can be supplied in one block.

The valid range for numeric values is 0-255. The CONTRAST and SATURATION properties are zero-centered, so the normal value is 127, such that the displayed picture is the same as the original. A value greater than 127 in either channel will cause the contrast or saturation to be increased, and similarly a value less than 127 will cause a decrease.

For example, to set the brightness to 50% and desaturate the image to Black & White:

```
MONITOR A:↵  
Brightness: 127↵  
Saturation: 0↵  
↵
```

Displaying SD in 16:9

The following command sets standard definition video to display in 16:9:

```
MONITOR A:↵  
WidescreenSD: ON↵
```

Displaying SD in 4:3

The following command sets standard definition video to display in 4:3:

```
MONITOR A:↵  
WidescreenSD: OFF↵
```

Identification and Tally Settings

The Identify flag is transient, and will cause a white border to be displayed around the entire picture for a duration of 15 seconds, after which it will be reset. This feature is primarily aimed at identifying which monitor is currently being configured when it is mounted in a rack comprising multiple units. To turn on:

```
MONITOR A:↵  
Identify: true↵  
↵
```

The IDENTIFY border will temporarily override any other border setting in effect.

The BORDER property can be used to programmatically set the soft Tally colored borders to one of the primary colors: RED, GREEN, BLUE, WHITE or NONE. This setting can be overridden by the electrical Tally signals at the DB-9 input on the device itself. For example, to set the soft Tally to green:

```
MONITOR B:↵  
Border: green↵  
↵
```

The hard wired tally will always override the soft tally. The full state report will always show the current valid border.

SmartScope Settings

On SmartScope Duo 4K, each monitor can be set to display a different scope. The values for activating specific scopes are mapped as follows:

- AudioDbfs
- AudioDbvu
- Histogram
- ParadeRGB
- ParadeYUV
- Picture (This is the same as Video Monitor)
- Vector100
- Vector75
- WaveformLuma

```
MONITOR A:↵  
ScopeMode: Picture↵  
↵
```

In the example above, Monitor A has been set as a video monitor.

Displaying SD in 16:9

The set Video Monitor mode to display standard definition video in 16:9:

```
MONITOR A:↵  
ScopeMode: Picture↵  
WidescreenSD: ON↵
```

Displaying SD in 4:3

To set Video Monitor mode to display standard definition video in 4:3:

```
MONITOR A:↵  
ScopeMode: Picture↵  
WidescreenSD: OFF↵
```

When setting one of SmartScope Duo 4K's monitors to audio metering, you can also select which channels to show. The values for selecting which audio channels are mapped in the following way:

- 0: Channels 1 and 2
- 1: Channels 3 and 4
- 2: Channels 5 and 6
- 3: Channels 7 and 8
- 4: Channels 9 and 10
- 5: Channels 11 and 12
- 6: Channels 13 and 14
- 7: Channels 15 and 16

```
MONITOR B:↵  
ScopeMode: AudioDbvu↵  
AudioChannel: 0↵
```

```
↵
```

In the example above, Monitor B has been selected to display Audio Metering in Dbvu with audio channels 1 and 2 selected for the phase meter.

Selecting LUTs for SmartView 4K

To select 3D LUTs using SmartView 4K:

```
MONITOR A:↵  
LUT: 0          LUT 1  
      1          LUT 2  
      NONE      DISABLE
```

```
↵
```

```
↵
```

지원

지원 받기

도움이 필요한 경우 다음 네 가지 방법을 사용하세요.

- 1 Blackmagic Design 고객 센터(www.blackmagicdesign.com/kr/support)를 방문하여 최신 지원 정보를 확인하세요.
- 2 Blackmagic Design 리셀러에게 연락하세요.
- 3 해당 지역의 리셀러로부터 Blackmagic Design의 최신 기술 업데이트를 즉각 지원받을 수 있습니다. 또한 리셀러는 워크플로에 필요한 여러 지원 방안을 제공하므로 리셀러로부터 지원받을 수 있는 부분에 관한 내용을 확인하시길 권장합니다.
- 4 또 다른 방법으로 www.blackmagicdesign.com/kr/support에 있는 '이메일 보내기' 버튼을 클릭해 문의사항을 이메일로 보내실 수 있습니다.
- 5 Blackmagic Design 지원 사무실로 연락하세요. 고객 지원 페이지 하단에 있는 '지역별 고객 지원팀 찾기' 버튼을 클릭해 가까운 사무실을 검색할 수 있습니다.

기술적인 문제 및 시스템 사양에 대한 정보를 최대한 자세히 알려주시면 가능한 한 신속하게 답변해드리겠습니다.

규제 사항

유럽 연합 국가 내의 전기전자제품 폐기물 처리 기준



제품에 부착된 기호는 해당 제품을 다른 폐기물과는 별도로 처리되어야 함을 나타냅니다. 제품을 폐기하려면 반드시 재활용 지정 수거 장소에 폐기해야 합니다. 폐기물 제품을 분리수거 및 재활용으로 처리하는 것은 자연 자원을 보전하고 인간의 건강과 환경을 보호할 수 있도록 폐기물을 재활용할 수 있는 방법입니다. 재활용을 위한 제품 폐기물 장소에 관한 자세한 정보는 해당 지역 시청의 재활용 센터 혹은 해당 제품을 구입한 상점으로 문의하십시오.



본 제품은 테스트 결과 FCC 규정 제15항에 따라 A급 디지털 기기 제한 사항을 준수하는 것으로 확인되었습니다. 해당 제한 사항은 본 제품을 상업적 환경에서 사용할 시 발생할 수 있는 유해 혼선으로부터 적절한 보호를 제공하기 위함입니다. 이 제품은 무선 주파수를 생성 및 사용, 방출할 수 있습니다. 따라서 설명서의 안내에 따라 제품을 설치 및 사용하지 않을 시, 무선 통신을 방해하는 전파 혼선을 일으킬 수 있습니다. 해당 제품을 주거 지역에서 사용할 경우, 유해 전파 혼선이 발생할 가능성이 있으며 이 경우, 사용자는 자체 비용으로 전파 혼선 문제를 해결해야 합니다.

제품 작동은 다음 두 가지 조건을 전제로 합니다.

- 1 본 기기는 유해 혼신을 일으키지 않습니다.
- 2 본 기기는 원치 않는 작동을 일으킬 수 있는 혼신 등의 모든 혼신을 수용합니다.

-



MSIP-REM-BMD-201410001
MSIP-REM-BMD-20150327
MSIP-REM-BMD-201702004
MSIP-REM-BMD-201702005

ISED 캐나다 성명

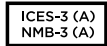

본 기기는 캐나다 표준 A급 디지털 장치 규정을 준수합니다.

정해진 사용 목적 이외의 다른 목적의 사용 또는 제품 변경은 표준 규정 위반으로 간주할 수 있습니다.

HDMI 인터페이스 연결 시에는 반드시 고품질의 쉴드 HDMI 케이블을 사용해야 합니다.

이 기기는 업무용 환경에서 사용할 목적으로 적합성 평가를 받은 기기로서, 가정용 환경에서 사용하는 경우, 전파간섭의 우려가 있습니다.

안전 정보

감전 예방을 위하여 본 제품은 반드시 보호 접지가 되어있는 메인 콘센트에 연결해야 합니다. 확실하지 않을 경우, 자격증이 있는 전기공에 연락하십시오.

감전 사고 위험을 줄이기 위해서 본 제품을 물이 튀거나 젖는 곳에 두지 마십시오.

본 제품은 주위 온도가 최대 40°C인 열대 지역에서 사용하기 적합합니다.

공기가 잘 통할 수 있도록 제품을 통풍이 잘되는 곳에 둡니다.

장비랙에 제품을 설치할 시, 주변 장비가 제품 통풍에 방해가 되지 않도록 주의하세요.

제품 내부에는 사용자가 수리 가능한 부품이 없습니다. 제품 수리는 해당 지역 Blackmagic Design 서비스 센터에 문의하세요.

일부 제품은 소형 폼팩터 플러그(SFP) 광섬유 모듈 옵션에 연결할 수 있는 기능을 탑재했습니다. 레이저 클래스 1 SFP 모듈 옵션만 사용할 수 있습니다.

권장 Blackmagic Design SFP 모듈

- **3G-SDI:** PL-4F20-311C
- **6G-SDI:** PL-8F10-311C
- **12G-SDI:** PL-TG10-311C



최대 작동 고도는 해수면 기준 2000m입니다.

캘리포니아주 성명

본 제품을 사용하는 사용자는 제품의 플라스틱 내 폴리브롬화 비페닐에 노출될 수 있으며 캘리포니아주에서는 해당 물질이 암, 선천적 결손증, 기타 생식기능의 손상을 유발하는 것으로 알려져 있습니다.

더욱 자세한 정보는 www.P65Warnings.ca.gov를 확인하세요.

보증

12개월 한정 보증

Blackmagic Design은 본 제품의 제조 및 재료에 어떠한 결함도 없음을 제품 구매일로부터 12개월 동안 보증합니다. 만약 결함이 보증 기간 동안 발견될 경우, Blackmagic Design은 당사의 결정에 따라 무상 수리 또는 새로운 제품으로 교환해드립니다.

구매 고객은 반드시 보증 기간이 만료되기 전에 결함 사실을 Blackmagic Design에 통지해야 적절한 보증 서비스를 제공받을 수 있습니다. 구매 고객은 지정된 Blackmagic Design 서비스 센터로 결함 제품을 포장 및 운송할 책임이 있으며, 운송 비용은 선불로 지급되어야 합니다. 또한 구매 고객은 또한 이유를 불문하고 제품 반송에 대한 운송료, 보험, 관세, 세금, 기타 비용을 부담할 책임이 있습니다.

이 보증은 부적절한 사용, 관리 및 취급으로 인한 파손, 고장, 결함에는 적용되지 않습니다. Blackmagic Design은 다음과 같은 경우에 보증 서비스를 제공할 의무가 없습니다. a) Blackmagic Design 판매 대리인이 아닌 개인에 의해 발생한 제품 손상. b) 부적절한 사용 및 호환되지 않는 장비와의 연결로 인한 제품 손상. c) Blackmagic Design사의 부품 및 공급품이 아닌 것을 사용하여 발생한 손상 및 고장. d) 제품을 개조하거나 다른 제품과 통합하여 제품 작동 시간 증가 및 기능 저하가 발생한 경우. BLACKMAGIC DESIGN에서 제공하는 제품 보증은 다른 모든 명시적 또는 묵시적 보증을 대신합니다. BLACKMAGIC DESIGN사와 관련 판매 업체는 상품성 및 특정 목적의 적합성과 관련된 모든 묵시적 보증을 부인합니다. BLACKMAGIC DESIGN의 결함 제품 수리 및 교환 관련에 대한 책임은 BLACKMAGIC DESIGN 또는 판매 업체에서 구매 고객에게 제공할 수 있는 관련 위험의 가능성에 대한 사전 통보의 여부와 관계없이 모든 간접적, 특별, 우발적, 결과적 손해에 대한 유일한 배상 수단입니다. BLACKMAGIC DESIGN은 고객이 장비를 불법적으로 사용하는 것에 대해서는 어떤 법적 책임도 지지 않습니다. BLACKMAGIC은 본 제품의 사용으로 인해 발생하는 손해에 대해서는 어떤 법적 책임도 지지 않습니다. 제품 사용으로 인해 발생할 수 있는 위험에 대한 책임은 본인에게 있습니다.

© Copyright 2020 Blackmagic Design. 모든 권리 보유. 'Blackmagic Design', 'DeckLink', 'HDLink', 'Workgroup Videohub', 'Multibridge Pro', 'Multibridge Extreme', 'Intensity', 'Leading the creative video revolution'은 모두 미국 및 기타 국가에 등록된 상표입니다. 다른 회사명 및 제품 이름은 관련 회사의 등록 상표일 수 있습니다.



Руководство по установке и эксплуатации

SmartView и SmartScope

Сентябрь 2018 г.

Русский



Добро пожаловать!

Мы стремимся к тому, чтобы телевидение стало областью настоящего творчества, в которой любой профессионал имеет возможность создавать материал самого высокого качества.

При создании такого материала необходимо контролировать качество сигнала. Модель SmartView 4K имеет ЖК-дисплей с разрешающей способностью 4K, что позволяет вести мониторинг Ultra HD-видео, а корпус 6 RU с панелью управления дает возможность быстро менять настройки. На SmartView HD (размер 6 RU) предусмотрен 17-дюймовый ЖК-монитор, а на SmartView Duo (размер 3 RU) — два независимых экрана с диагональю 8" каждый. SmartScope Duo 4K также имеет два дисплея и обеспечивает мониторинг формы сигнала при работе вне студии. Благодаря наличию интерфейса 3G-SDI вся линейка решений SmartView поддерживает вывод в SD, HD и 2K, а SmartScope Duo 4K и SmartView 4K — Ultra HD 4K через 6G-SDI и 12G-SDI соответственно.

Мониторы позволяют выполнять технически точный контроль сигнала, а утилита Blackmagic SmartView Setup имеет простой и интуитивно понятный набор инструментов.

Это руководство содержит всю информацию, необходимую для работы с мониторами SmartView или SmartScope. Если вы не знаете, как установить IP-адрес и сетевые параметры, лучше всего обратиться за помощью к техническому специалисту. Использование устройства не требует специальных навыков, однако в начале необходимо выполнить определенную настройку.

Процесс установки занимает приблизительно пять минут. Чтобы загрузить последнюю версию руководства и программного приложения, посетите раздел поддержки на нашем сайте www.blackmagicdesign.com/ru. Не забудьте зарегистрировать ваше устройство, и тогда мы будем сообщать вам о выходе очередного релиза ПО. Мы постоянно работаем над совершенствованием наших продуктов, поэтому ваши отзывы помогут нам сделать их еще лучше!

Грант Петти

Генеральный директор Blackmagic Design

Содержание

SmartView и SmartScope

Подготовка к работе	285
SmartView и SmartScope	285
Подключение источников видео	286
Подключение к компьютеру	286
Установка утилиты Blackmagic SmartView Setup	287
Работа с утилитой Blackmagic MultiView Setup	288
Обновление программного обеспечения	288
Изменение настроек монитора	288
Enable tally override	291
Работа со SmartView 4K	291
Обзор Blackmagic SmartView 4K	291
Кнопки панели управления	292
Загрузка 3D LUT с помощью Blackmagic SmartView Setup	294
Работа со SmartScope Duo 4K	295
Обзор Blackmagic SmartScope	295
Мониторинг видео	296
Форма сигнала	297
Вектороскоп	298
Дисплей параметров	299
Гистограмма	301
Уровень звука	302
Подключение к локальной сети	303
Подключение к сети Ethernet	303
Сетевой коммутатор	304
Изменение сетевых настроек	305
Сетевые параметры	305
Добавление монитора	307
Индикация состояния	308
Контакты порта Tally-индикации	308
Регулировка угла обзора	309
Информация для разработчиков	311
Blackmagic 2K Format – Overview	311
Blackmagic 2K Format – Vertical Timing Reference	312
Blackmagic 2K Format – Data Stream Format	313
Blackmagic SmartView Ethernet Protocol v1.3	314
Помощь	318
Соблюдение нормативных требований	319
Правила безопасности	320
Гарантия	321

Подготовка к работе

SmartView и SmartScope

Мониторы SmartView превосходно подходят для размещения в стойке с оборудованием. Чтобы приступить к работе, достаточно включить питание и соединить устройство с источником SDI-сигнала.

Модель SmartView 4K имеет 15,6-дюймовый ЖК-дисплей, который обеспечивает вывод SD-, HD- или Ultra HD-видео в разрешении 3840 x 2160. С помощью кнопок на передней панели можно выбрать вход, настроить яркость экрана, проверить шум в синем канале, просмотреть служебные данные и применить 3D LUT-таблицу.

ЖК-экран SmartView HD размером 17 дюймов идеально подходит для мониторинга сигнала в разрешении Full HD.

SmartView Duo имеет два дисплея для одновременного вывода разных потоков. Например, можно использовать комбинацию YUV 4:2:2 и RGB 4:4:4 или NTSC и PAL. В каждом случае потребуется только подключить SDI-кабель к каждому источнику изображения.

SmartScope Duo 4K имеет такой же набор функций, как SmartView Duo, но дополнительно позволяет выводить форму сигнала, использовать вектроскоп и другие индикаторы для мониторинга видео- и аудиосигнала в реальном времени. Кроме того, эта модель поддерживает Ultra HD 4K.

SDI-интерфейс мониторов SmartView и SmartScope автоматически определяет формат поступающего видео от SD и HD до 3G-SDI, в том числе 2K. Модель SmartView 4K с поддержкой 12G-SDI также позволяет работать с Ultra HD, включая 2160p/60, а SmartScope Duo 4K — с Ultra HD 4K через 6G-SDI.

Для удаленной настройки нескольких мониторов SmartView и SmartScope с одного компьютера допускается их последовательное подключение через локальную сеть Ethernet. В этом случае отпадает необходимость делать это в индивидуальном порядке через USB-порт.

Все готово для начала работы! Подробнее о подключении SmartView и SmartScope, настройке мониторов с помощью утилиты Blackmagic SmartView Setup и соединении устройств по сети см. разделы ниже.



SmartView 4K



SmartView HD



SmartView Duo



SmartScope Duo 4K

Подключение источников видео

Мониторы SmartView и SmartScope оснащаются стандартными BNC-разъемами, которые обеспечивают совместимость с традиционным SDI-оборудованием, в том числе видеомикшерами, камерами, платами захвата, деками и дисковыми рекордерами.

Вывод изображения

Для вывода изображения достаточно подключить питание и соединить источник сигнала с SDI-входом. После этого оно появится на дисплее монитора. Устройство автоматически определяет формат входящего видео на SDI и сквозном интерфейсе (SD, HD и 2K, а также Ultra HD 4K при работе с SmartView 4K и SmartScope Duo 4K).

При отсутствии входящего сигнала подсветка устройства отключается.

Последовательное соединение мониторов

SmartView и SmartScope имеют независимый SDI-вход и сквозной выход, что позволяет выполнить последовательное подключение нескольких мониторов для передачи одного и того же сигнала.

- 1 Включите питание на устройстве № 1. Подключите источник видео к SDI-входу. Изображение будет поступать на экран.
- 2 Включите питание на устройстве № 2. С помощью SDI-кабеля соедините сквозной выход устройства № 1 с SDI-входом решения № 2.

Количество подключаемых устройств не ограничено.

При выводе формы сигнала с помощью SmartScope Duo 4K можно подключить выход монитора № 1 к монитору № 2 для проверки одного и того же изображения на обоих дисплеях.

При выводе изображения можно менять настройки или выбирать индикаторы на SmartScope Duo 4K с помощью утилиты Blackmagic SmartView Setup, а также загружать 3D LUT-таблицы на Blackmagic SmartView 4K.



Подключение к компьютеру

Для настройки монитора SmartView или SmartScope подключите его к ПК с помощью USB-кабеля и установите утилиту Blackmagic SmartView Setup.

Порт USB также служит для обновления программного обеспечения, загруженного с веб-сайта Blackmagic Design. Установка последней версии ПО позволяет расширить функционал, улучшить совместимость с аппаратными средствами и гарантирует поддержку дополнительных форматов и стандартов. Утилиту Blackmagic SmartView Setup можно использовать на компьютерах с операционной системой macOS или Windows.

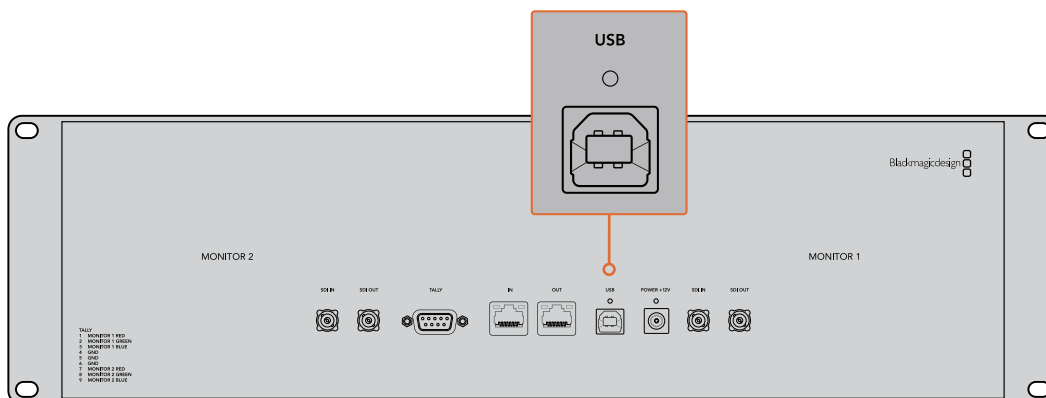

Установка утилиты Blackmagic SmartView Setup

Утилита Blackmagic SmartView Setup совместима с операционной системой macOS (версии Sierra и High Sierra), а также Windows 8.1 и 10 (64-разрядная версия с последними пакетами обновления). При необходимости установка допускается на несколько сетевых компьютеров.

Комплект поставки включает SD-карту с ПО, но мы рекомендуем использовать последнюю версию, которую можно загрузить на нашем веб-сайте по адресу www.blackmagicdesign.com/ru/support.

Установка на macOS

Дважды щелкните кнопкой мыши по значку мастера установки SmartView на SD-карте или в папке загрузок. В разделе Applications (Приложения) будет создана новая папка SmartView, содержащая утилиту SmartView Setup, деинсталлятор для удаления устаревших версий при обновлении системы и различные документы, включая руководство пользователя.

Установка на Windows

В операционной среде Windows откройте SD-карту или загруженный zip-файл и щелкните дважды по мастеру установки SmartView. Далее следуйте инструкциям на экране.

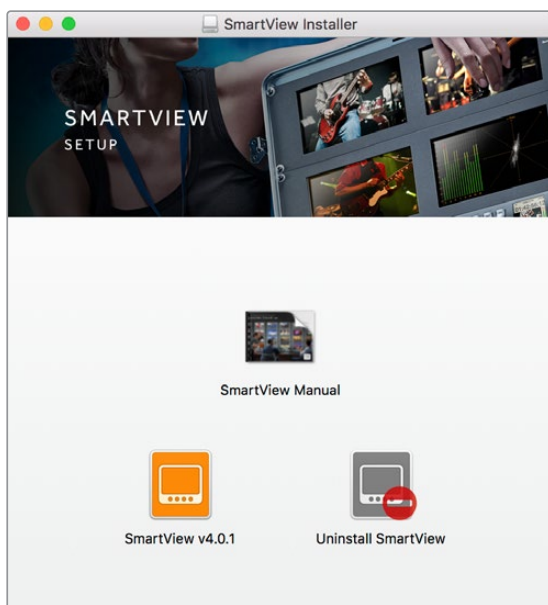

В операционной среде macOS запустите файл SmartView.dmg с SD-карты либо из папки загруженных документов, затем дважды щелкните по значку мастера установки SmartView

Работа с утилитой Blackmagic MultiView Setup

Обновление программного обеспечения

После завершения установки Blackmagic SmartView Setup щелкните по значку настроек под названием монитора. Если используемая версия устарела, появится сообщение с предложением обновить ПО SmartView или SmartScore. Для этого выполните описанные ниже действия.

- 1 Соедините монитор SmartView или SmartScore с компьютером через порт USB или Ethernet и запустите утилиту Blackmagic SmartView Setup.
- 2 При появлении сообщения выберите Update. Процесс обновления занимает около пяти минут.
- 3 По окончании обновления появится сообщение "This SmartView has been updated".
- 4 Выберите Close.

Если используется актуальная версия, откроется страница с настройками монитора.

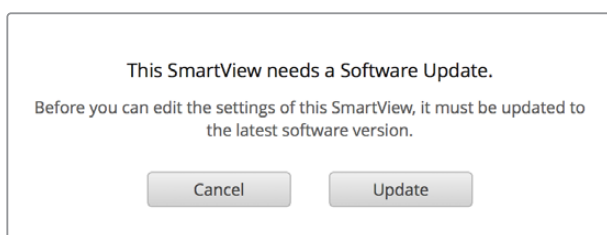

Если необходимо обновить ПО, при запуске утилиты Blackmagic SmartView Setup появится соответствующее сообщение

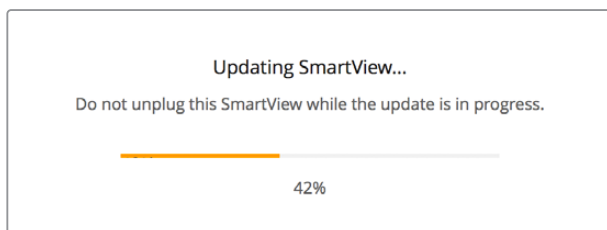

Процесс обновления занимает около пяти минут

Изменение настроек монитора

При запуске утилиты Blackmagic SmartView Setup будет выполнен поиск устройств SmartView или SmartScore, подключенных через USB или Ethernet, с отображением результатов на начальной странице SmartView Setup. При наличии двух или более мониторов для перехода к нужному используют левую и правую стрелки по бокам начальной страницы. Если устройство подключено через порт USB, рядом с его именем появится соответствующий значок.

Чтобы изменить используемые параметры, выберите монитор и нажмите на значок настроек под именем монитора. Откроется соответствующая страница. После завершения настройки нажмите кнопку Save, чтобы сохранить изменения и вернуться к начальной странице.

Подробнее о настройках на мониторах Blackmagic и их применении см. следующий раздел. Информацию об установке сетевых параметров с помощью Blackmagic SmartView Setup можно найти в разделе «Изменение сетевых настроек».

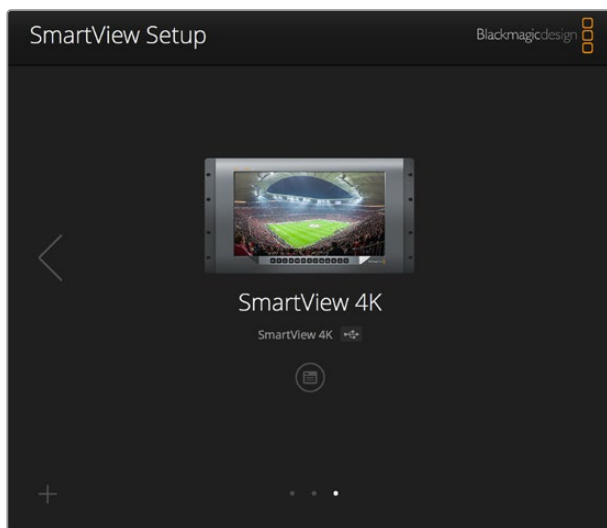

Утилита Blackmagic SmartView Setup автоматически выполняет поиск устройств SmartView и SmartScope, подключенных по сети или через порт USB. При обновлении программного обеспечения убедитесь в наличии соединения с монитором через нужный порт. При использовании USB-интерфейса рядом с именем отображается соответствующий значок.

Настройки Monitor

Для выполнения настройки и вывода параметров монитор должен быть подключен через Ethernet или USB. С помощью левой или правой стрелки на начальной странице SmartView Setup перейдите к нужному устройству, затем под его именем выберите соответствующий значок. На странице настроек автоматически отображается комбинация поддерживаемых опций в соответствии с выбранной моделью.

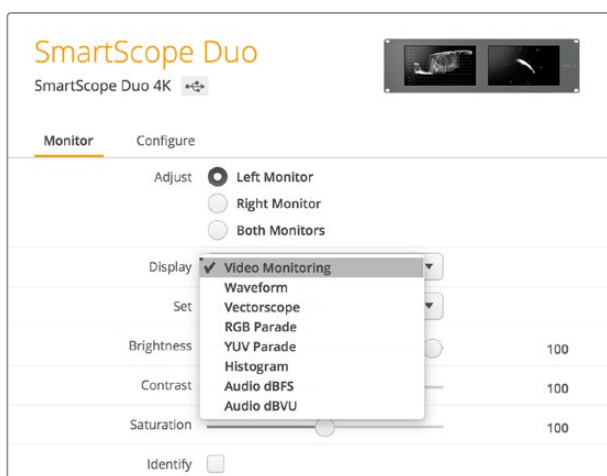

В раскрывающемся меню Display выберите Video Monitoring или нужный индикатор параметров

Настройка Adjust

При работе со SmartScore или SmartView Duo выберите нужный монитор: Left Monitor (левый), Right Monitor (правый) или Both Monitors (оба). Если используется настройка Both Monitors, любые изменения яркости, контрастности или насыщенности будут применяться к обоим мониторам.

Настройка Display

При работе со SmartScore раскрывающееся меню Display содержит доступные индикаторы параметров. Чтобы выводить изображение без индикации, выберите опцию Video Monitoring.

Настройка Set

При работе со SmartScore раскрывающееся меню Set позволяет выбрать пропорции кадра (4:3 или 16:9) для вывода SD-видео, а для настройки Display можно использовать разные индикаторы, в том числе Vectorscope, Audio dBFS и Audio dBVU.

- **Video Monitoring:** вывод изображения с пропорциями кадра 4:3 или 16:9. При просмотре широкоэкранного анаморфного SD-видео выберите опцию 16:9, в остальных случаях — 4:3.
- **Vectorscope:** выберите настройку 100% или 75% в зависимости от используемого тестового сигнала с цветными полосами.
- **Audio dBFS:** выбор пары звуковых каналов для мониторинга фазы.
- **Audio dBVU:** выбор пары звуковых каналов для мониторинга фазы.

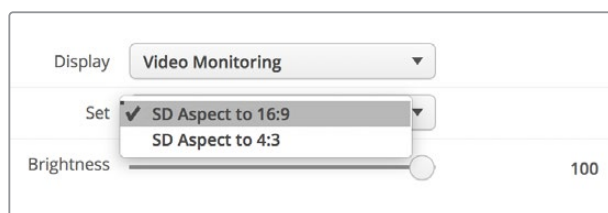

При просмотре анаморфного SD-видео выберите опцию SD Aspect to 16:9

Настройки Brightness, Contrast и Saturation

Изменение яркости, контрастности и насыщенности с помощью соответствующих слайдеров. На моделях SmartView и SmartScore доступные настройки разнятся.

Настройка Identify

Поставьте флажок для настройки Identify, чтобы отображать белую рамку на дисплее того устройства, которое выбрано в Blackmagic SmartView Setup. Это облегчает идентификацию, если к локальной сети подключено несколько мониторов SmartView и SmartScore.

При использовании совместно с настройкой Both Monitors белая рамка отображается на обоих дисплеях мониторов SmartView Duo и SmartScore Duo 4K.

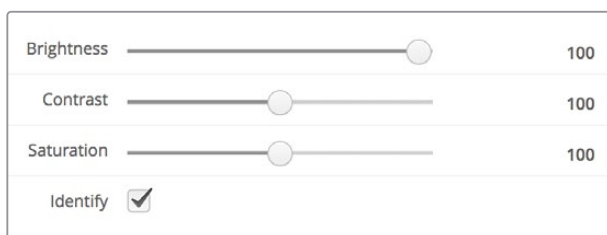

Передвиньте слайдер вправо или влево для изменения настроек Brightness, Contrast или Saturation. Чтобы визуально идентифицировать выбранный монитор, поставьте флажок для Identify.

Enable tally override

Чтобы включить рамки Tally-индикации на модели Blackmagic SmartView 4K, выберите опцию Enable tally override. Эта функция совместима с камерами Blackmagic URSA Mini Pro 4.6K и Blackmagic URSA Broadcast.

Подключите SDI-выход камеры ко входу A или B на SmartView 4K.

Соедините программный выход видеомикшера ATEM с SDI-входом камеры.

Когда видеомикшер ATEM переключает камеру на программный вывод, на SmartView 4K появляется красная рамка Tally-индикации. При переходе в режим предварительного просмотра она становится зеленой.

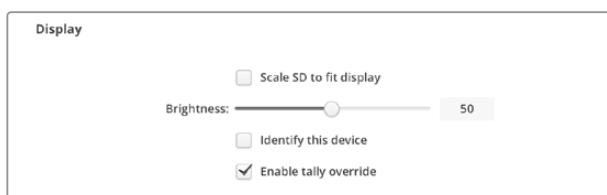

Когда к монитору SmartView 4K подключена камера Blackmagic URSA Mini Pro или URSA Broadcast, для вывода на него рамок Tally-индикации выберите опцию Enable tally override

Работа со SmartView 4K

Обзор Blackmagic SmartView 4K

Вещательный монитор SmartView 4K имеет интерфейс 12G-SDI для работы с Ultra HD при размере корпуса 6 RU. Эта модель поддерживает SD-, HD- и Ultra HD-форматы вплоть до 2160p/60, а яркий дисплей с широкой диагональю обеспечивает точную фокусировку и мониторинг цвета.

Модель SmartView 4K предназначена для использования в стационарных и мобильных студиях. Боковое расположение интерфейсов и возможность крепления по стандарту VESA позволяют выполнять установку в условиях ограниченного пространства, на стену или поворотный кронштейн. SmartView 4K поддерживает два способа управления: с помощью встроенной панели или удаленно через Ethernet при отсутствии локального доступа.

Два многоскоростных интерфейса 12G-SDI позволяют использовать разные источники SDI-сигнала, а наличие гнезда для SFP-модуля по стандарту SMPTE обеспечивает передачу видео по оптоволоконному соединению. Выход 12G-SDI дает возможность выводить изображение на любое оборудование. Для сетевого соединения, удаленного управления и сквозного вывода при последовательном подключении к другим мониторам есть два порта Ethernet. Дополнительно предусмотрены разъемы для индикации состояния во время эфирной работы и порт USB для обновления программного обеспечения.

С помощью Blackmagic SmartView Setup можно загрузить созданные в DaVinci Resolve 3D LUT-таблицы как файлы .cube, чтобы выводить изображение с камеры на SmartView 4K в том виде, который максимально приближен к конечной версии после грейдинга. Два уровня выделения контуров обеспечивают точную фокусировку, а совместимость с источниками постоянного и переменного тока позволяет подключать SmartView 4K к основной сети энергоснабжения и к внешнему аккумулятору на площадке.

SmartView 4K является идеальным решением для мониторинга в студийных и мобильных условиях, обеспечивая вывод не только SD- и HD-, но и Ultra HD-видео с разрешением 3840 x 2160 пикселей.

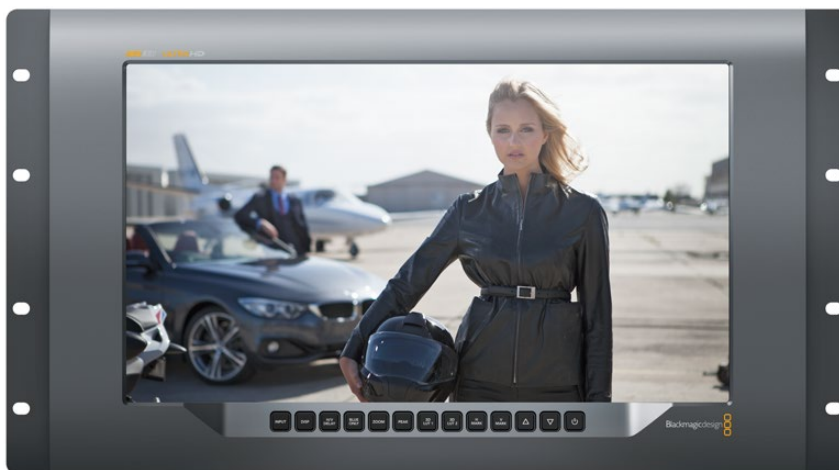

ПРИМЕЧАНИЕ. При подключении внешнего источника питания ко входу постоянного тока убедитесь в том, что выходной разъем аккумулятора рассчитан на мощность 24 Вт с напряжением 12 В.

Кнопки панели управления

Кнопки на панели управления служат для быстрого изменения настроек монитора SmartView 4K.

INPUT

Служит для выбора входящего сигнала с одного из двух интерфейсов 12G-SDI или дополнительного оптического SFP-модуля. Если видео не поступает на выбранный вход, отображается черный экран. При переключении между входами в левом верхнем углу экрана кратковременно выводится информация о формате поступающего сигнала.

DISP

Служит для настройки яркости ЖК-дисплея с помощью стрелок вверх и вниз. Нажмите кнопку DISP еще раз для выхода.

H/V DELAY

Служит для вывода дополнительных данных, встроенных в SDI-видео. Чтобы увидеть данные, расположенные горизонтально, нажмите кнопку один раз. Нажмите еще раз для показа вертикальных данных, например скрытых субтитров.

BLUE ONLY

Если в цифровом видеосигнале есть шум, он заметен в синем канале. Чтобы проверить наличие шума, нажмите кнопку BLUE ONLY. После этого будет выводиться черно-белое изображение, которое также может служить для проверки фокуса камеры.

ZOOM

Служит для увеличения масштаба. Нажмите кнопку один раз, чтобы проверить фокусировку. Для возврата к обычному размеру нажмите еще раз.

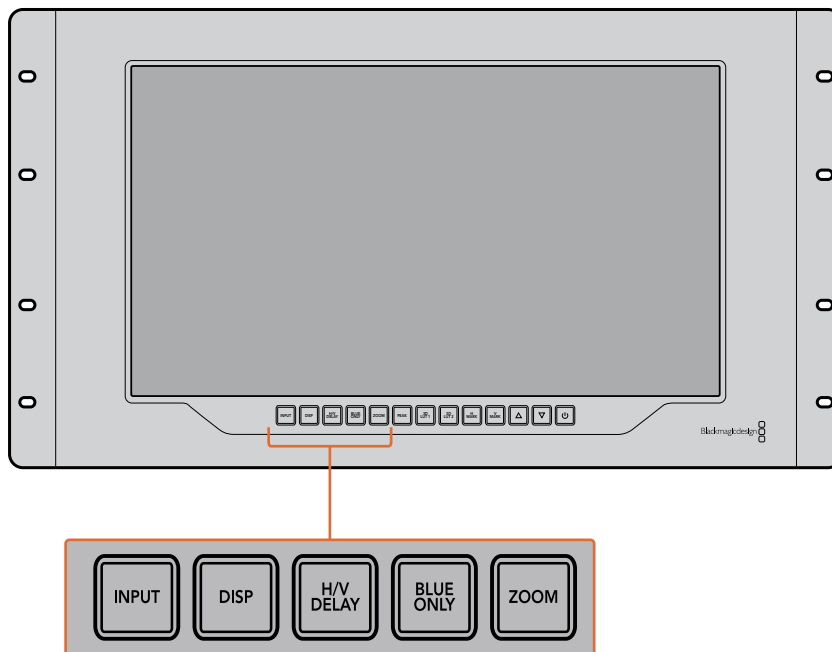

PEAK

Служит для проверки фокусировки с помощью выделения контуров изображения. Вокруг наиболее резких элементов будет отображаться зеленая кромка. Для этой функции предусмотрены два уровня с последовательным переключением от одной настройки к другой. Когда зеленая кромка имеет наиболее отчетливый вид, фокус камеры настроен точно.

3D LUT 1 и 3D LUT 2

Служат для вывода изображения с применением пользовательских таблиц 3D LUT, созданных в Blackmagic DaVinci Resolve (файлы с расширением .cube). Для включения нажмите кнопку один раз. Чтобы отключить LUT-таблицы, нажмите еще раз. Подробнее о работе с 3D LUT-таблицами на SmartView 4K см. раздел «Загрузка 3D LUT с помощью Blackmagic SmartView Setup».

H MARK и V MARK

Кнопки служат для вывода и редактирования маркеров кадра, с помощью которых можно сохранять важную информацию или графику в безопасной зоне экрана. Так как границы кадра различаются в зависимости от типа телевизора или дисплея, центральная область изображения будет всегда оставаться видимой.

Для вывода горизонтальных или вертикальных маркеров кадра нажмите соответственно H MARK или V MARK. Нажмите еще раз, чтобы отредактировать настройки. С помощью стрелок вверх и вниз можно менять их позицию. Нажмите для подтверждения новых координат. Чтобы отключить маркеры, нажмите кнопку еще раз.

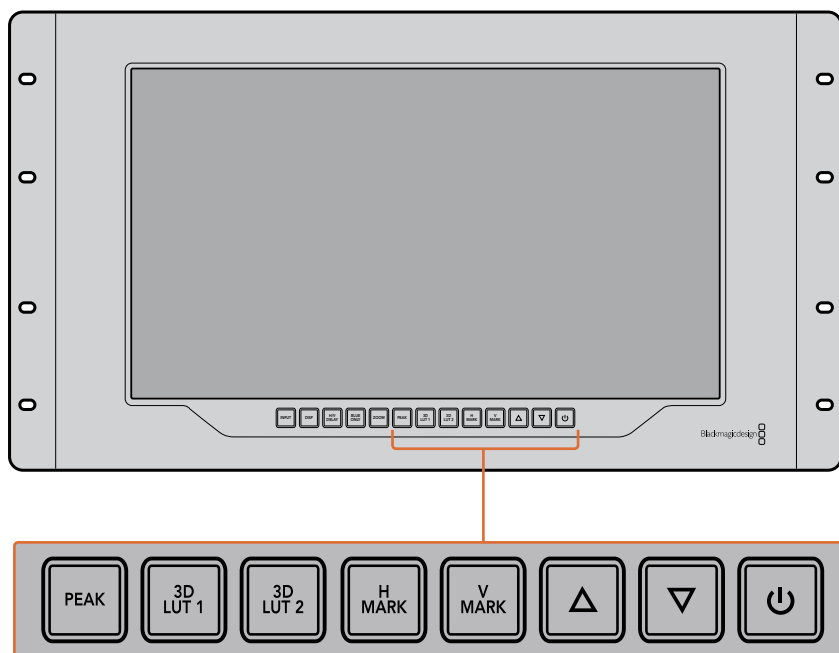

Стрелки вверх и вниз

Служат для изменения настроек (например, для увеличения или уменьшения яркости, а также при редактировании положения маркеров).

Питание

Нажмите кнопку питания, чтобы включить SmartView 4K. Для отключения устройства нажмите кнопку еще раз.

Загрузка 3D LUT с помощью Blackmagic SmartView Setup

SmartView 4K позволяет вести мониторинг с помощью 3D LUT-таблиц. Это дает возможность настраивать устройство с использованием профессиональных средств калибровки или просматривать материал в том виде, который максимально приближен к конечной версии после грейдинга. 3D LUT-таблицы также помогают экспериментировать с разными цветовыми схемами. Для загрузки на SmartView 4K используют утилиту Blackmagic SmartView Setup. Так как монитор поддерживает файлы с расширением .cube, допускается работа с собственными таблицами, созданными в Blackmagic DaVinci Resolve. Подробнее о создании файлов см. руководство по DaVinci Resolve.

Порядок загрузки 3D LUT-таблиц

- 1 Запустите утилиту Blackmagic SmartView Setup.
- 2 Нажмите кнопку Load для Load LUT 1. Откроется диалоговое окно для указания пути к загружаемой таблице. Выберите необходимый файл с расширением .cube, затем нажмите Open.
- 3 Для просмотра загруженной таблицы выберите 3D LUT 1 на панели управления SmartView 4K. Для отключения нажмите соответствующую кнопку еще раз.

Чтобы загрузить вторую LUT-таблицу, выполните аналогичные действия для 3D LUT 2.

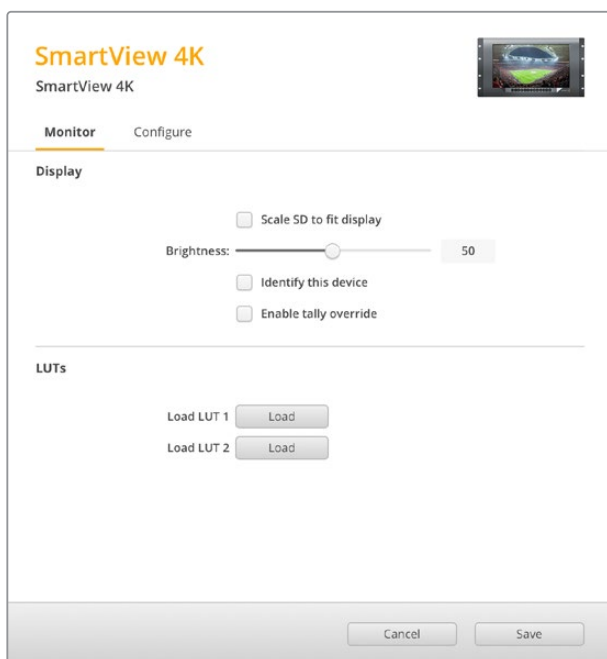

Для загрузки 3D LUT-таблицы на SmartView 4K используют утилиту Blackmagic SmartView Setup

Работа со SmartScope Duo 4K

Обзор Blackmagic SmartScope

Традиционные осциллографы, используемые в постпроизводстве и на телевидении, являются очень дорогостоящими устройствами и при этом способны выводить на экран только по одному параметру за раз.

SmartScope Duo 4K имеет два дисплея, которые позволяют в реальном времени контролировать различные параметры сигнала, при этом изменение способа представления с помощью утилиты Blackmagic SmartView Setup сразу применяется к изображению на экране устройства. Каждый входящий поток, поступающий через сквозной SDI-интерфейс, можно направлять на любой из двух дисплеев: например, индикаторы сигнала — на правый, а само изображение — на левый.

Индикаторы, отображаемые на SmartScope Duo 4K, можно выбрать с помощью утилиты Blackmagic SmartView Setup. Для этого перейдите к раскрывающемуся меню Display.

Подробнее о назначении каждого из индикаторов и способах их использования см. разделы ниже.

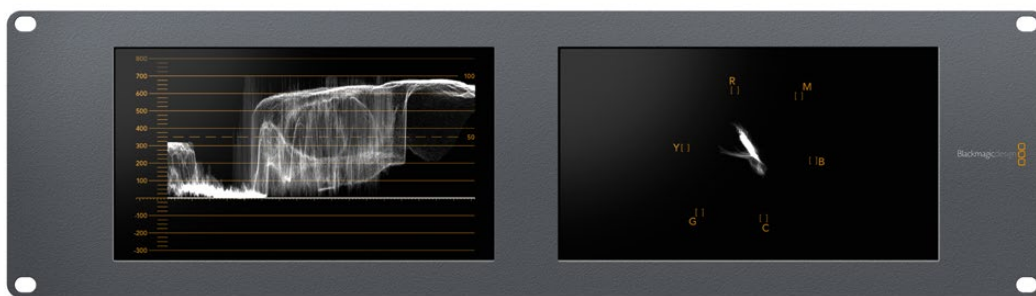

С помощью Blackmagic SmartView Setup на дисплеи монитора Blackmagic SmartScope Duo 4K можно выводить различные индикаторы

Мониторинг видео

Когда для настройки Display используется опция Video Monitoring, на экран выводится поступающее на вход изображение.

Для SD-сигнала в меню Set можно выбрать пропорции кадра 4:3 или 16:9. Любые изменения настроек яркости, контрастности или насыщенности можно сразу увидеть на дисплее. Они применяются только для отображения на мониторе, но не затрагивают непосредственно сам сигнал.

Один дисплей можно использовать для вывода видео, а другой — для отображения индикаторов. Для этого соедините сквозной SDI-выход монитора № 1 и вход монитора № 2 с помощью короткого кабеля.

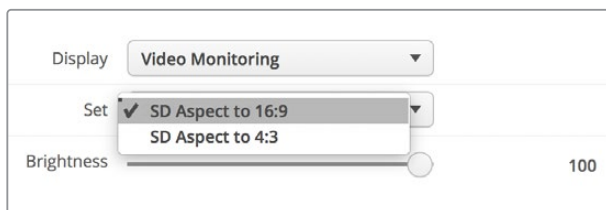

В меню Set утилиты Blackmagic SmartView Setup для SD-видео можно выбрать пропорции кадра 4:3 или 16:9. Для просмотра анаморфного изображения используется вторая опция.

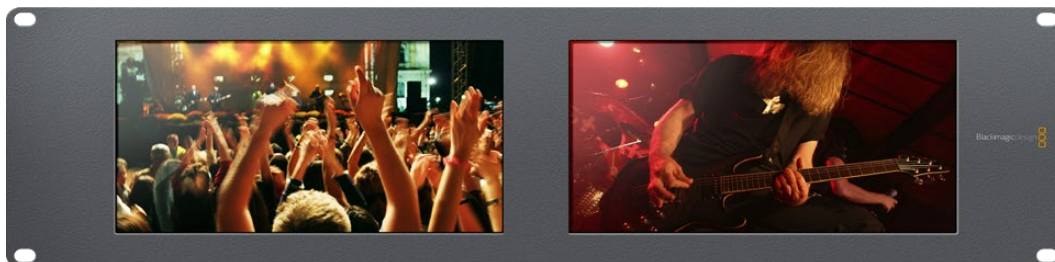

Опция Video Monitoring для настройки Display позволяет выводить изображение в таком же виде, в каком оно поступает на экран телевизора или монитора

Форма сигнала

Этот индикатор служит для отображения формы сигнала в цифровом виде и используется для мониторинга видео и настройки его уровня яркости.

В отличие от традиционных мониторов, которые способны работать только с аналоговым композитным видео в стандартном разрешении, SmartScope Duo 4K поддерживает SD, HD и Ultra HD. Это позволяет вести полноценный контроль уровня яркости даже при работе с форматами высокой четкости.

Для этого выберите опцию Waveform в раскрывающемся меню Display утилиты Blackmagic SmartView Setup. Чтобы не допустить засветки или затемнения, уровень яркости не должен опускаться ниже 0% и подниматься выше 100%.

Форма сигнала — это графическое представление изображения, показывающее уровни яркости с распределением в границах кадра. Например, если засвечена часть неба, это будет заметно на соответствующем участке.

Вид формы сигнала зависит от съемочного материала. При мониторинге кадров с высокой контрастностью полутона могут отсутствовать. На рисунке ниже показана форма сигнала с равномерной экспозицией: левая часть соответствует темному участку, а область от центра к правому краю кадра — более светлым зонам.

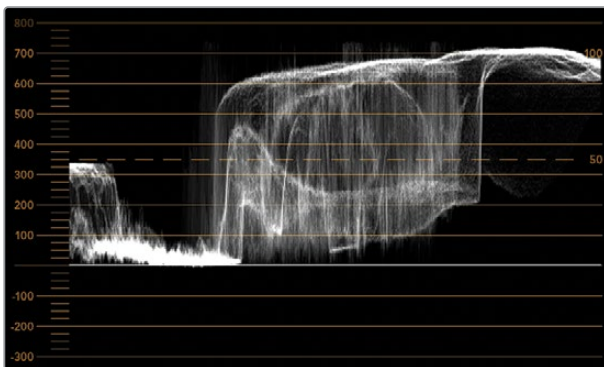

Дисплей формы сигнала показывает уровни яркости

Adjust	<input checked="" type="radio"/> Left Monitor
	<input type="radio"/> Right Monitor
	<input type="radio"/> Both Monitors
Display	Waveform ▼
Set	No Options ▼

Чтобы увидеть параметры яркости сигнала, выберите опцию Waveform для настройки Display

Вектороскоп

Этот индикатор позволяет получить информацию о цветах видеосигнала. Выберите 100% или 75% в раскрывающемся меню Set в зависимости от используемого тестового сигнала с цветными полосами.

Иногда считают, что с помощью вектороскопа можно выявлять некорректные уровни сигнала. Подобное мнение ошибочно, потому что для этого нужно видеть значения цветности и яркости. Чтобы определить некорректные уровни, используется дисплей RGB Parade. Цвета, приближенные к белому или черному, не могут быть такими же насыщенными, как более глубокие цвета, формирующие различные оттенки. Так как вектороскоп не показывает значения яркости, его нельзя использовать только для выявления некорректных уровней.

Вектороскоп идеально подходит для проверки и коррекции цвета в изображении, полученном со старых аналоговых видеопленок. Для этого достаточно воспроизвести нужный фрагмент, а затем скорректировать параметры цветности и тона с помощью шкалы.

Вектороскоп будет незаменимым инструментом при выполнении цветокоррекции, потому что он позволяет проверить баланс белого. Если изображение содержит какой-либо цветовой оттенок, информация о нем будет смещаться от центра вектороскопа и может иметь две точки. Если в сигнале используется гашение, то обычно в центре диаграммы отображается точка, потому что во время гашения видео представляет собой черное поле. Оно может служить полезной контрольной точкой, с помощью которой легко установить отсутствие информации о цвете.

Если изображение содержит какой-либо цветовой оттенок, информация о нем будет смещаться от центра. Степень смещения зависит от интенсивности цветового оттенка и затрагивает участки, отображающие как светлые, так и темные тона. Благодаря этому вектороскоп можно использовать для удаления цветовых оттенков и сохранения правильного баланса белого.

Вектороскоп позволяет корректировать цвет без добавления нежелательных оттенков в областях света и тени. Хотя баланс цвета можно контролировать с помощью дисплея RGB Parade и вектороскопа, проблемы с этим параметром проще отследить во втором случае.

При установке цвета человеческого лица параметр насыщенности обычно должен соответствовать положению «10 часов» на вектороскопе. Это положение называется линией «телесного тона» и позволяет добиться такого цвета кожи, который будет выглядеть естественным независимо от расовой принадлежности человека.

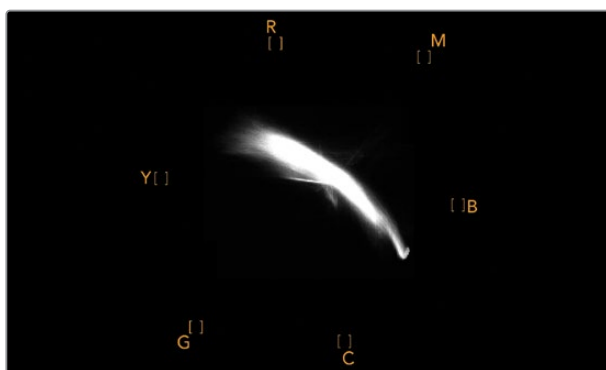

Линия «телесного тона» соответствует положению «10 часов» на вектороскопе

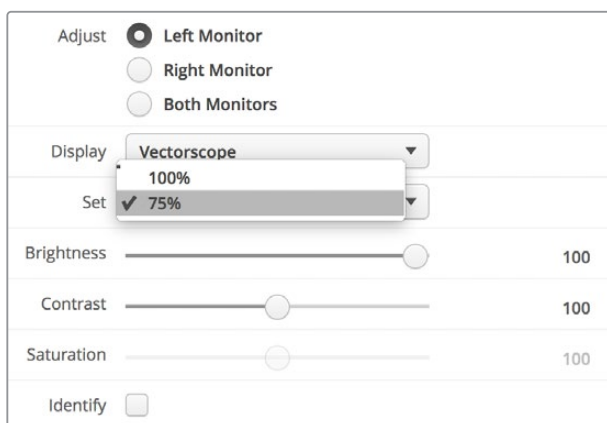

Выберите 100% или 75% в зависимости от используемого тестового сигнала с цветными полосами

Дисплей параметров

Дисплеи RGB Parade и YUV Parade позволяют получить информацию о некорректных уровнях цвета и идеально подходят для грейдинга.

При выполнении цветокоррекции выберите RGB Parade в раскрывающемся меню Display. Дисплей RGB Parade отображает по отдельности полную шкалу красного, зеленого и синего каналов. Когда изображение представлено в таком виде, проще контролировать цветовой баланс в областях света, полутона и тени, а также удалять нежелательную тонировку.

Во время выполнения цветокоррекции важно сохранять сигнал в заданных границах. При увеличении его уровня нужно следить за тем, чтобы он не выходил за пределы, установленные для параметров RGB. Независимо от используемого оборудования, монитор SmartScope Duo 4K позволяет всегда видеть некорректные уровни RGB-изображения.

Некорректные уровни могут проявляться как засветка или затемнение изображения. В некоторых системах грейдинга уровень черного можно уменьшить ниже 0%. При наличии некорректных уровней черного для их компенсации увеличьте значение Lift или Gain, но убедитесь в том, что уровень сигнала не превышает 100%, чтобы не допустить засветки в областях света.

Для проверки уровней YUV выберите в раскрывающемся меню Display опцию YUV Parade. В этом случае параметры яркости будут отделены от цвета подобно тому, как принято в телевидении. Левая часть дисплея соответствует яркости, а второй и третий индикаторы содержат информацию о цвете. YUV Parade позволяет выполнять калибровку цвета по тестовым шаблонам для корректной передачи вещательного сигнала на экраны телевизоров.

Благодаря цветокоррекции можно получить максимально качественное изображение с сохранением уровней сигнала в заданных границах.

Термины цветокоррекции

Тени – темные тона.

Гамма – средние тона.

Света – светлые тона.

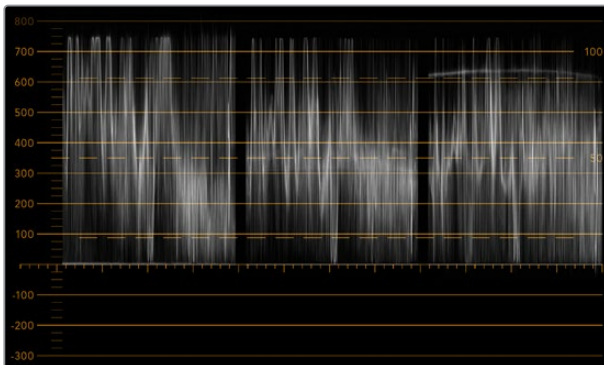

RGB Parade

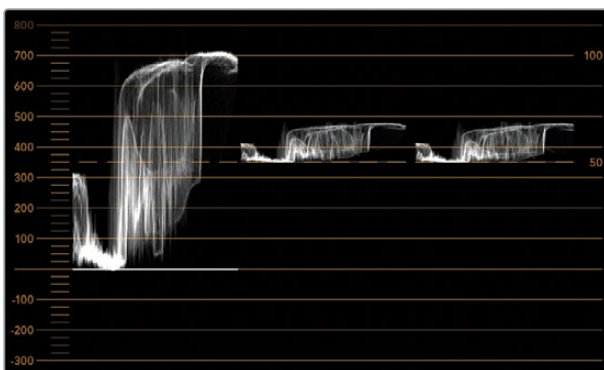

YUV Parade

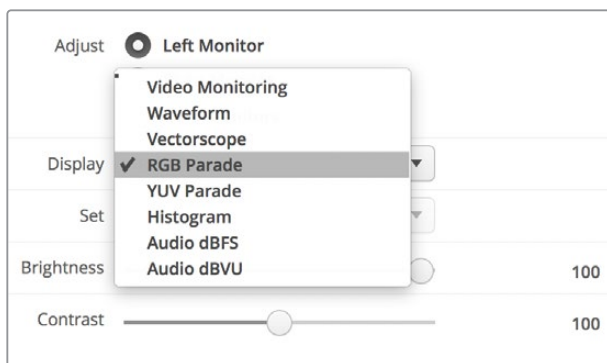

В раскрывающемся меню Display выберите дисплей RGB Parade или YUV Parade

Гистограмма

С гистограммой чаще всего имеют дело графические дизайнеры и операторы камер. Она показывает распределение элементов изображения от белого к черному цвету и позволяет увидеть недостаточную или избыточную экспозицию. С ее помощью можно также контролировать изменение видео при корректировке средних тонов.

В левой части дисплея сосредоточена информация о темных тонах, в правой части — о светлых. Как правило, она должна находиться в интервале от 0% до 100%. При недостаточной или избыточной экспозиции информация об изображении выходит за эти крайние точки. Дефекты экспозиции осложняют обработку изображения и его цветокоррекцию на этапе постпроизводства, поэтому во время съемки важно следить за тем, чтобы гистограмма не опускалась ниже крайней левой точки и не поднималась выше крайней правой точки. В этом случае колорист будет иметь больше свободы при выполнении грейдинга.

Когда во время цветокоррекции применяют засветку или затемнение, гистограмма отображает этот эффект и показывает степень недостаточной или избыточной экспозиции. Средние тона позволяют добиться сходного эффекта и при этом сохранить больше деталей.

Гистограмма не подходит для проверки некорректных уровней, хотя дает возможность увидеть недопустимые значения светлых и темных тонов. Так как она не отображает цвета, некорректные уровни нельзя увидеть даже при их наличии. Для выявления таких уровней нужно использовать индикатор RGB Parade, который показывает как цвет, так и яркость элементов видеосигнала.

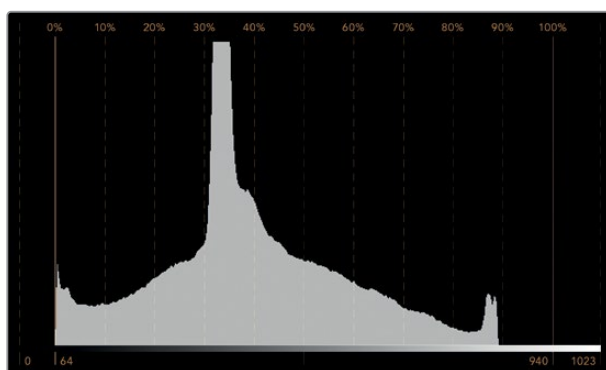

Гистограмма показывает распределение элементов изображения от белого к черному цвету

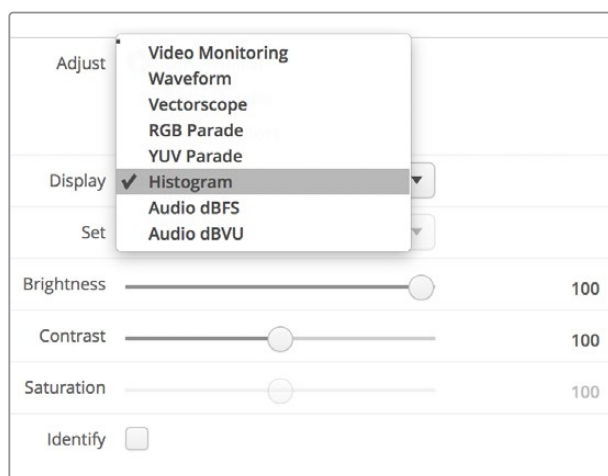

В раскрывающемся меню Display выберите Histogram

Уровень звука

Этот индикатор показывает уровень звука, встроенного в SDI-видео. Из поступающего потока извлекается до 16 каналов аудио, которые отображаются в режиме dBVU или dBFS.

Индикатор VU показывает средние уровни сигнала, прост в применении и чаще встречается на оборудовании предыдущего поколения. Он откалиброван в соответствии с рекомендациями SMPTE (тональный тест-сигнал 1 кГц имеет значение -20 dBFS).

dBFS представляет собой индикатор всего цифрового аудиосигнала и обычно используется в современном оборудовании.

Аудиометр в правой части экрана предназначен для мониторинга двух каналов звука, которые выбирают в раскрывающемся меню Set (Phase scope to 1 & 2, Phase scope to 3 & 4 и т. д.). Он отображает моно- или стереодорожку в двухмерной системе координат и позволяет выявлять нарушение баланса и несовпадение по фазе. Монодорожка будет представлена в виде единичной вертикальной линии. Если показана горизонтальная линия, имеет место сдвиг фазы, что может привести к потере сигнала при передаче на другое оборудование. Несовпадение по фазе — одна из самых частых технических проблем при использовании большого количества соединений.

При мониторинге стереодорожки сигнал имеет округлую форму, отображая разницу между правым и левым аудиоканалами. Чем больше стереозвук содержится в аудиодорожке, тем более закругленным будет изображение на экране. Если аудио содержит минимальное количество стереоэффектов, форма сигнала вытягивается вдоль вертикальной линии.

Речь обычно отображается как вертикальная линия, а музыка со стереоэффектами — как эллипс или круг. Это объясняется тем, что аудиометр показывает монодорожку как L+R на вертикальной оси, а стереодорожку — в виде разницы L-R на горизонтальной оси.

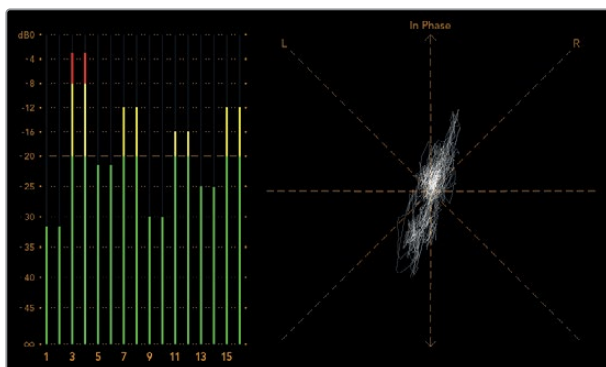

Индикатор уровня звука показывает пиковые значения и баланс аудио

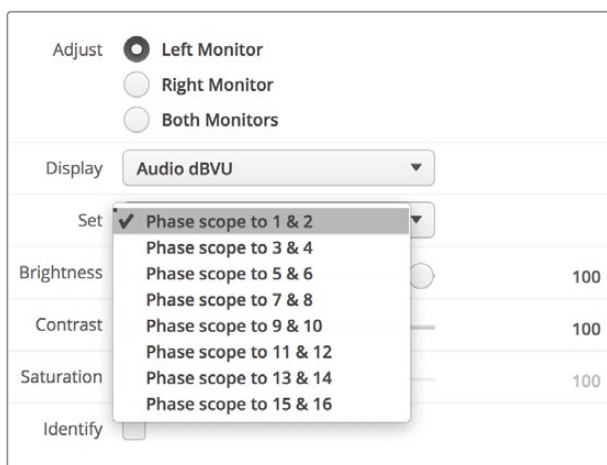

В раскрывающемся меню Set выберите пару аудиоканалов для мониторинга

Подключение к локальной сети

Подключив SmartView или SmartScore к локальной сети, можно выполнить удаленную настройку сразу нескольких мониторов.

Хотя SmartView и SmartScore позволяют выводить видео без предварительной настройки, сначала нужно установить сетевые параметры. Это можно сделать только путем прямого подключения оборудования к компьютеру через порт USB.

Подключение к сети Ethernet

Удаленная настройка монитора выполняется путем прямого подключения к компьютеру по локальной сети Ethernet, при этом использование сетевого коммутатора не требуется. Дополнительные устройства можно соединить между собой по цепочке через порт Ethernet. На каждое из них должно поступать питание.

Когда мониторы подключают без указания IP-адресов или локальная сеть отсутствует, соедините SmartView или SmartScore напрямую с портом Ethernet на компьютере. В этом случае можно обойтись без кабеля для использования с сетевым коммутатором.

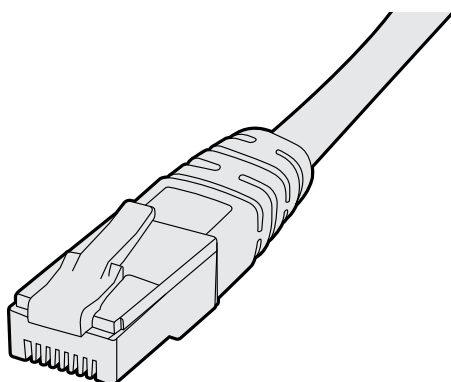

Подключение через Ethernet

Сетевой коммутатор

При работе с несколькими мониторами SmartView или SmartScope в локальной сети только один из них нужно соединить с сетевым коммутатором, а остальные можно подключить последовательным способом через сквозной порт Ethernet. Питание должно подаваться на все устройства в цепочке.

Соединение с сетевым коммутатором позволяет изменить настройки устройства с любого локального компьютера. Если сеть имеет беспроводную точку доступа, это можно сделать через Wi-Fi с помощью ноутбука (операционная система Mac или Windows).

Ниже описан порядок подключения SmartView и SmartScope к локальной сети с IP-адресами.

- 1 Соедините устройство с поставляемым блоком питания и включите его.
- 2 Для соединения с сетевым коммутатором или при подключении напрямую к компьютеру используйте стандартный кабель Ethernet с разъемом RJ45.

Схема соединения в сети Ethernet

Монитор можно подключить напрямую к компьютеру через порт Ethernet без использования сетевого коммутатора. При последовательном соединении питание должно подаваться на все устройства в цепочке.



Схема соединения с коммутатором в сети Ethernet

При работе с несколькими мониторами в локальной сети только один из них нужно соединить с сетевым коммутатором, а остальные можно подключить последовательным способом. Питание должно поступать на все устройства.

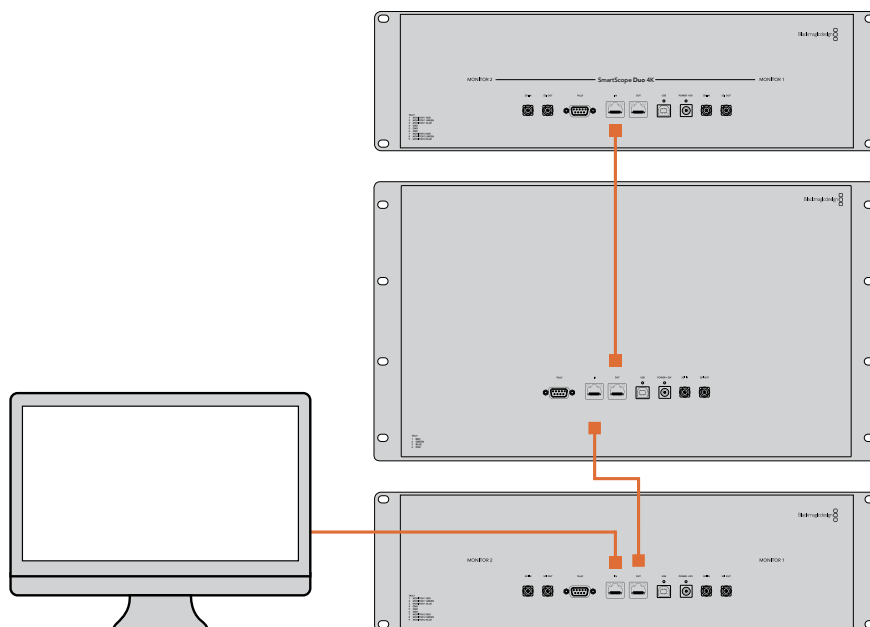
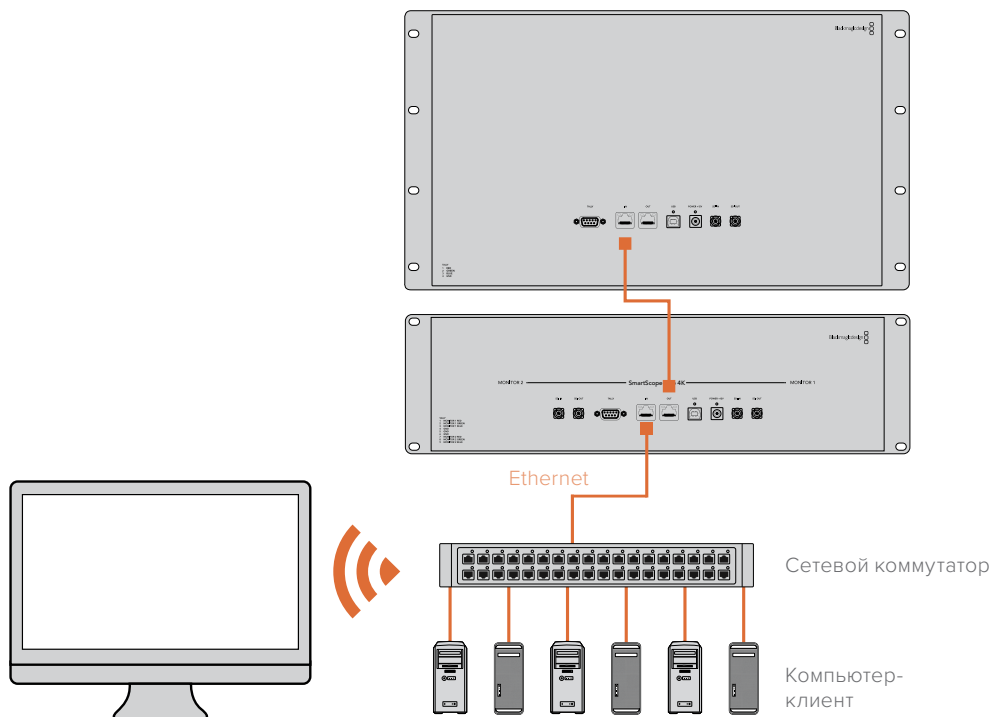

Изменение сетевых настроек

Сетевые параметры

Имя устройства

Для удобства идентификации можно изменить имена мониторов SmartView и SmartScope (например, «Внестудийные камеры 1 и 2», «Многооконный выход», «4K-видео» и т. д.).

Чтобы изменить имя устройства, убедитесь, что оно подключено через порт Ethernet или USB. Откройте утилиту Blackmagic SmartView Setup и выберите значок настроек под именем монитора. Перейдите к разделу сетевых параметров и в строке Name раздела Details укажите новое имя. При использовании недопустимого значения появится соответствующее предупреждение. Если формат имени корректен, рядом с ним будет отображаться флажок зеленого цвета. Нажмите Enter (ввод) с клавиатуры, чтобы подтвердить изменение.

Сетевые параметры

Чтобы изменить сетевые настройки с помощью утилиты Blackmagic SmartView Setup, монитор должен быть подключен к компьютеру через порт USB. Порт Ethernet не предназначен для этих целей.

По умолчанию для автоматического получения сетевого IP-адреса используется настройка DHCP.

Чтобы получить DHCP-адрес в случае отсутствия DHCP-сервера, можно активировать функцию Internet Sharing (на macOS) или Internet Connection Sharing (ICS) (Windows 8.1 или Windows 10). Это поможет избежать ввода статических IP-адресов вручную, в том числе без подключения компьютера к Интернету. Подробнее см. разделы справки в ОС macOS, Windows 8.1 или Windows 10.

Если DHCP не используется, выберите Static IP. При установке статического IP-адреса обратитесь за помощью к системному администратору. Каждому устройству SmartView или SmartScore необходимо присвоить уникальный IP-адрес и общий адрес для Subnet Mask. Настройки по умолчанию в поле Gateway менять не нужно, если монитор не подключен к сетевому шлюзу (например, к интернет-коммутатору).

Если мониторы SmartView и SmartScore не обнаружены, скорее всего им не были присвоены IP-адреса с помощью протокола DHCP. В этом случае необходимо ввести соответствующие сетевые настройки вручную в описанном ниже порядке.

- 1 Подключите монитор SmartView или SmartScore к компьютеру через порт USB и откройте утилиту Blackmagic SmartView Setup.
- 2 Подключенный монитор будет автоматически распознан и показан на начальной странице Blackmagic SmartView Setup, а рядом с его именем появится значок USB.
- 3 Измените сетевые настройки монитора.
- 4 Повторите описанные выше действия для других мониторов, которым не были присвоены IP-адреса с помощью протокола DHCP.

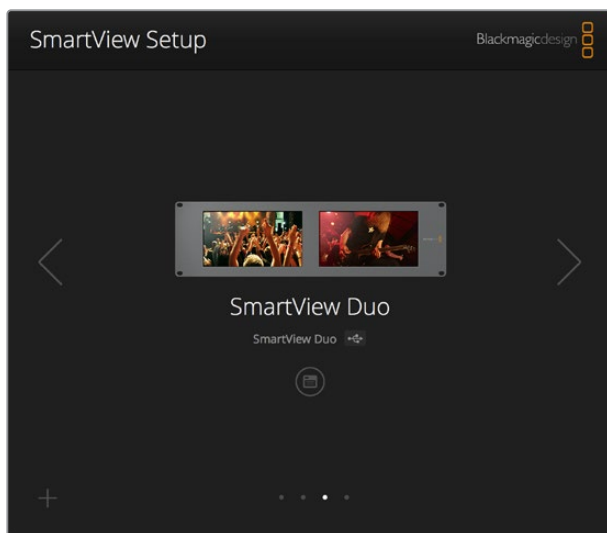

Значок USB рядом с именем монитора указывает на то, что он подключен к компьютеру через порт USB. Это соединение используют для изменения сетевых настроек монитора.

Monitor Configure	
Details	
Name:	SmartView Duo
Software Version:	4.0.1
Network Settings	
IP setting:	<input type="radio"/> DHCP <input checked="" type="radio"/> Static IP
IP Address:	192.168.10.42 ✓
Subnet Mask:	255.255.255.0
Gateway:	192.168.10.1
Cancel Save	

Сетевые настройки можно установить двумя способами (DHCP или Static IP). Для их изменения используется подключение через порт USB.

Добавление монитора

Если SmartView или SmartScore Duo 4Кне отображается на главной странице утилиты SmartView Setup, но известен IP-адрес устройства, его можно добавить вручную. Для этого выполните описанные ниже действия.

- 1 Убедитесь, что устройство подключено через порт Ethernet. Выберите знак плюса в нижнем левом углу экрана. Откроется диалоговое окно для добавления монитора.
- 2 Введите IP-адрес устройства и нажмите Add.
- 3 Будет проверено наличие подключенных устройств и добавлен новый монитор, информация о котором появится на главной странице утилиты SmartView Setup. Чтобы увидеть его, нажмите на правую стрелку.

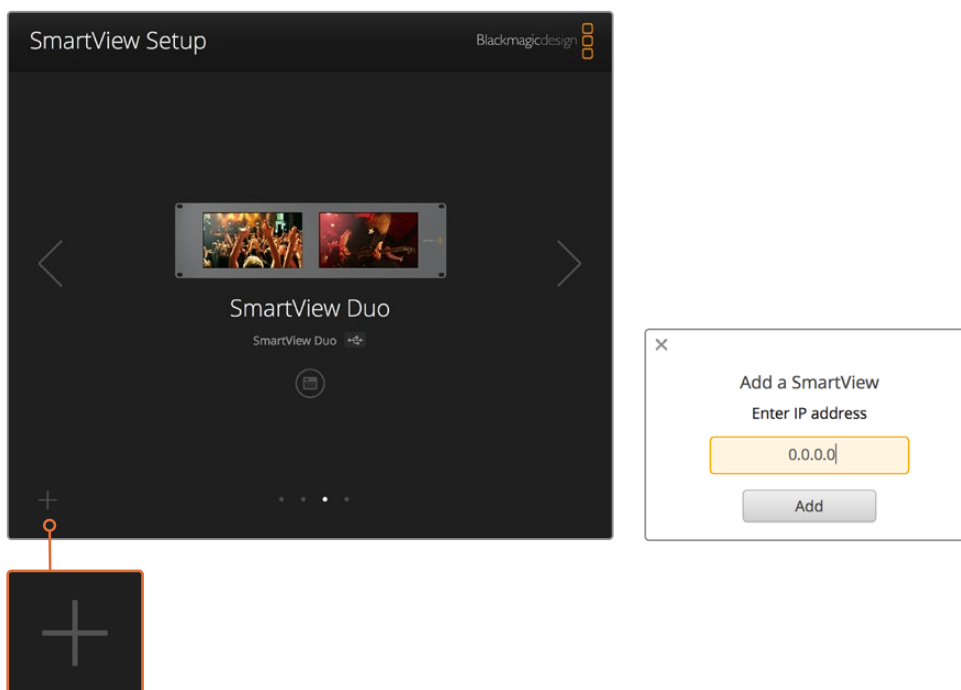

Чтобы добавить монитор SmartView или SmartScore к списку подключенных устройств, выберите знак плюса и введите IP-адрес

Индикация состояния

Контакты порта Tally-индикации

Если вы не используете индикацию состояния при работе со SmartView или SmartScore, перейдите к следующему разделу.

Все мониторы SmartView и SmartScore поддерживают индикацию состояния, которая отображается как красная, зеленая или синяя рамка (в эфире, предварительный просмотр или запись соответственно).

9-контактный разъем типа D-sub может принимать сигналы замыкания с видеомикшера и систем автоматизации. Подробнее см. схему подключения и разводки.

Схема с описанием 9-контактного разъема типа D находится на задней панели устройства.

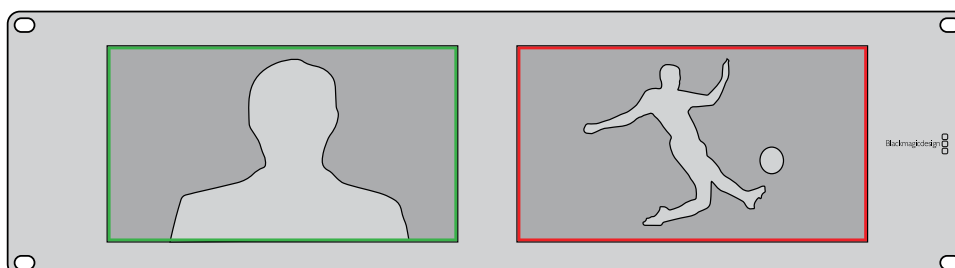

На экранах SmartView Duo для индикации используются рамки зеленого и красного цвета

SmartView Duo и SmartScope Duo 4K	
Назначение контактов	
Контакт	Функция
1	Монитор 1, рамка красного цвета
2	Монитор 1, рамка зеленого цвета
3	Монитор 1, рамка синего цвета
4	Земля
5	Земля
6	Земля
7	Монитор 2, рамка красного цвета
8	Монитор 2, рамка зеленого цвета
9	Монитор 2, рамка синего цвета

Порт Tally-индикации на SmartView

SmartView HD и SmartView 4K	
Назначение контактов	
Контакт	Функция
1	Красный
2	Зеленый
3	Синий
4	Земля

Регулировка угла обзора

При размещении мониторов SmartView Duo, SmartView HD и SmartScope в стойке с оборудованием можно перевернуть устройство, чтобы получить оптимальный угол обзора. В этом случае ориентация выводимого на экраны изображения поменяется автоматически. Чтобы снять лицевую панель и установить ее обратно, понадобится отвертка Pozidriv 2. Это простая процедура, не требующая разборки корпуса.

Ниже описан порядок снятия и обратной установки лицевой панели для сохранения логотипа Blackmagic Design в исходном положении. Для этого понадобится отвертка Pozidriv 2.

- 1 Открутите винты со всех четырех сторон лицевой панели. Модели SmartView Duo и SmartScope Duo 4K имеют по 10 винтов, SmartView HD — 18.
- 2 Приподнимите панель и снимите ее, как показано на рисунке.
- 3 Переверните панель.
- 4 Установите панель обратно.
- 5 Закрепите панель на корпусе с помощью винтов.

Теперь устройство готово к установке в стойку. После этого изображение будет выводиться с нужной ориентацией без регулировки с помощью внешних органов управления.



Для проверки оптимального угла обзора рекомендуется попробовать разные варианты

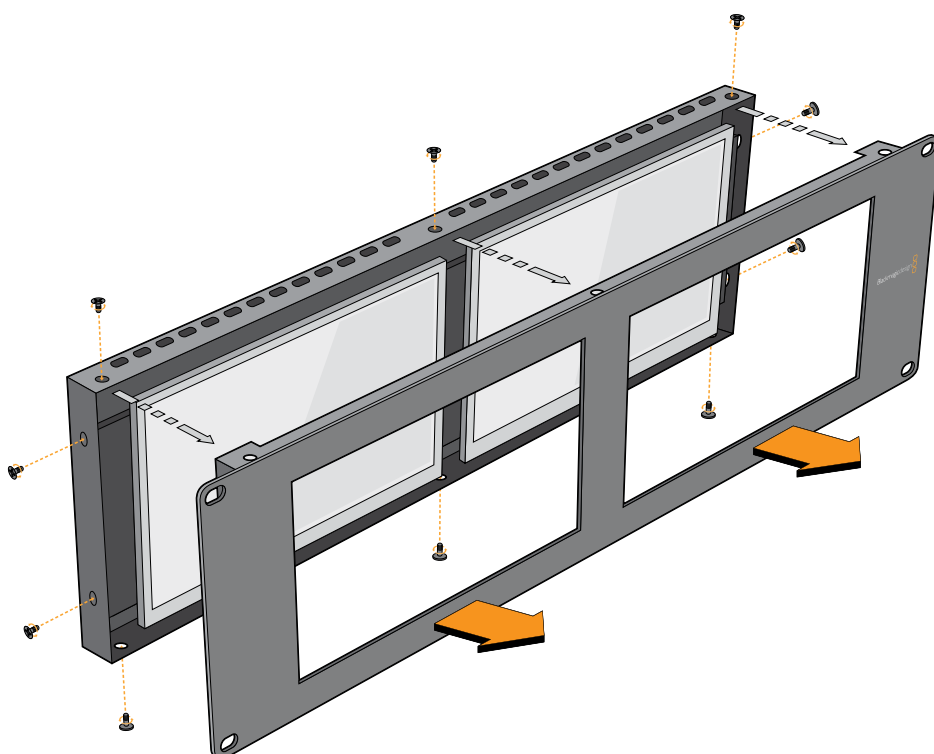

Чтобы снять лицевую панель с корпуса, открутите все винты

Информация для разработчиков

Developing Custom Software Using Blackmagic Design Hardware

The Blackmagic SmartView Ethernet Protocol allows developers to remotely control Blackmagic SmartView and SmartScope hardware with their own custom software. The Blackmagic SmartView Ethernet Protocol is a text-based status and control protocol.

Downloading the Free SmartView Ethernet Protocol

The Blackmagic SmartView Ethernet Protocol is free. It is included in this SmartView & SmartScope manual and can be downloaded from www.blackmagicdesign.com/ru/support

Joining the Blackmagic Design Developer List

The Blackmagic Developer mailing list is designed for technical questions regarding technologies used by Blackmagic Design, e.g., QuickTime, Core Media, DirectShow, codecs, APIs, SDKs, etc. The free mailing list is a forum where developers can discuss ideas and problems with other developers. Any subscriber may reply and the Blackmagic Design engineers may also respond when appropriate. You can subscribe to the mailing list at: <http://lists.blackmagicdesign.com/mailman/listinfo/bmd-developer>

In some cases, we might request a brief outline of the software you are developing if it is not immediately obvious from your domain name that your organization develops video software. Please don't take offence as we're simply trying to keep the list free of spam and viruses as well as end-user customers asking non-development questions, employment agents or sales people trying to promote products on the list. The list is just for developers.

Contacting Blackmagic Design Developer Assistance

You can also contact us via developer@blackmagicdesign.com if you have any developer related questions or wish to ask questions off the list.



Blackmagic 2K Format – Overview

Blackmagic Design products support 3G-SDI video, which allows twice the data rate of traditional HD-SDI video. We thought it would be a really nice idea to add 2K film support, via 3G-SDI technology, so we could simplify feature film workflows. With the popularity of Blackmagic Design editing systems worldwide, now thousands of people can benefit from a feature film workflow revolution.

This information includes everything product developers need to know for building native 2K SDI equipment. Of course, all Blackmagic products can be updated, so if the television industry adopts an alternative SDI-based film standard, we can add support for that too!

Frame Structure

- Transmitted at 23.98, 24 or 25 frames per second as a Progressive Segmented Frame.
- Active video is 2048 pixels wide by 1556 lines deep.
- Total lines per frame : 1650
- Active words per line are 1535. One word consists of a 10-bit sample for each of the four data streams, i.e., a total of 40 bits. See the diagram named Blackmagic 2K Format - Data Stream Format.
- Total active lines : 1556
- Total words per line : 1875 for 23.98/24Hz and 1800 for 25Hz.
- Fields per frame : 2, 825 lines each
- Active lines located on lines 16-793 (field 1) and 841-1618 (field 2).

Transport Structure

- Based on SMPTE 372M Dual Link mapping and SMPTE 425M-B support for mapping SMPTE 372M into a single 3 Gb/s link.
- Timing reference signals, line number and line CRC insertion is the same as above.
- During active video, 10-bit Red, Green and Blue data is sent in the following sequence:
- Optional ancillary data is inserted into both virtual interfaces.
- At present, only audio data is included: as per standard HD audio insertion (SMPTE S299M) the audio data packets are carried on data stream two and audio control packets are carried on data stream one.
 - Data stream 1: Green_1, Green_2, Green_3, Green_5...Green_2047
 - Data stream 2: Blue_1, Blue_2, Green_4, Blue_5...Green_2048.
 - Data stream 3: Red_1, Blue_3, Blue_4, Red_5...Blue_2048.
 - Data stream 4: Red_2, Red_3, Red_4, Red_6...Red_2048.

Blackmagic 2K Format – Vertical Timing Reference

This diagram shows the vertical timing details with line numbers and Field, Vertical and Horizontal bits for the Timing Reference Signal codes.

		Field 1					Active							
F	1	0	0	0	0	0	0	0	0	0	0	0	0	
V	1	1	1	1	1	1	0	0	0	0	1	1		
LINE #	1650	1	2	...	14	15	16	...	792	793	...	825		

		Field 2					Active							
F	0	1	1	1	1	1	1	1	1	1	1	1		
V	1	1	1	1	1	1	0	0	0	0	1	1		
LINE #	825	826	827	...	839	840	841	...	1617	1618	...	1650		

Blackmagic 2K Format – Data Stream Format

This diagram shows the data stream formats around the optional ancillary data section of the horizontal line. Note that each active pixel takes up three samples.

Word# 25 PsF	Word# 23.98/24 PsF	Data Stream 4	Data Stream 3	Data Stream 2	Data Stream 1
1795	1870	R2042	R2041	B2041	G2041
1796	1871	R2043	B2043	B2042	G2042
1797	1872	R2044	B2044	G2044	G2043
1798	1873	R2046	R2045	B2045	G2045
1799	1874	R2047	B2047	B2046	G2046
1800	1875	R2048	B2048	G2048	G2047
1	1	EAV(3FFh)	EAV(3FFh)	EAV(3FFh)	EAV(3FFh)
2	2	EAV(000h)	EAV(000h)	EAV(000h)	EAV(000h)
3	3	EAV(000h)	EAV(000h)	EAV(000h)	EAV(000h)
4	4	EAV(XYZh)	EAV(XYZh)	EAV(XYZh)	EAV(XYZh)
5	5	LN0	LN0	LN0	LN0
6	6	LN1	LN1	LN1	LN1
7	7	CRC0	CRC0	CRC0	CRC0
8	8	CRC1	CRC1	CRC1	CRC1
9	9	200	040	ANC/Audio Data	ANC/Audio Data
...		
260	335	200	040		
261	336	SAV(3FFh)	SAV(3FFh)	SAV(3FFh)	SAV(3FFh)
262	337	SAV(000h)	SAV(000h)	SAV(000h)	SAV(000h)
263	338	SAV(000h)	SAV(000h)	SAV(000h)	SAV(000h)
264	339	SAV(XYZh)	SAV(XYZh)	SAV(XYZh)	SAV(XYZh)
265	340	R2	R1	B1	G1
266	341	R3	B3	B2	G2
267	342	R4	B4	G4	G3
268	343	R6	R5	B5	G5

Blackmagic SmartView Ethernet Protocol v1.3

Summary

The Blackmagic SmartView Ethernet Protocol is a text-based status and control protocol, very similar in structure to the Videohub protocol, that is accessed by connecting to TCP port 9992 on a SmartView or SmartScope device.

Upon connection, the SmartView or SmartScope device sends a complete dump of the state of the device. After the initial dump, state changes are sent asynchronously.

The device sends information in blocks which have an identifying header, followed by a colon. A block can span multiple lines and is terminated by a blank line.

To be resilient to future protocol changes, clients should ignore blocks they do not recognize, up to the trailing blank line. Within recognized blocks, clients should ignore lines they do not recognize.

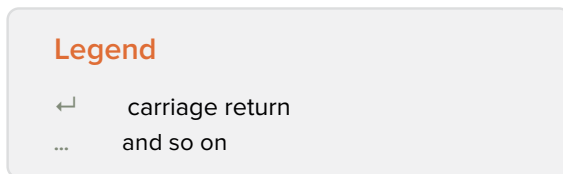

Version 1.3 of the Blackmagic SmartView Ethernet Protocol was released with SmartView 1.3 software.

Protocol Preamble

The first block sent by the SmartView Server is always the protocol preamble:

```
PROTOCOL PREAMBLE:↵
Version: 1.3 ↵
↵
```

The version field indicates the protocol version. When the protocol is changed in a compatible way, the minor version number will be updated. If incompatible changes are made, the major version number will be updated.

Device Information

The next block contains general information about the connected SmartView or SmartScope device.

```
SMARTVIEW DEVICE:↵
Model: SmartView Duo↵
Hostname: stagefront.studio.example.com↵
Name: StageFront↵
Monitors: 2↵
Inverted: false↵
↵
```

This example shows the output for a SmartView Duo device, which has two LCDs.

The INVERTED flag indicates whether the device has detected that it has been mounted in an inverted configuration to optimize LCD viewing angle.

Network Configuration

The next block shows the TCP/IP networking configuration:

```
NETWORK:↵
Dynamic IP: true↵
Static address: 192.168.2.2↵
Static netmask: 255.255.255.0↵
Static gateway: 192.168.2.1↵
Current address: 192.168.1.101↵
Current netmask: 255.255.255.0↵
Current gateway: 192.168.1.1↵
↵
```

The network settings prefixed with CURRENT show the active TCP/IP settings, and are read-only. The CURRENT settings reflect either the DHCP or Static configuration, depending on the DYNAMIC IP flag.

Changing Networking Settings

The network can be configured to use either DHCP or a static configuration. To enable DHCP:

```
NETWORK:↵
Dynamic IP: true↵
↵
```

To set a fixed IP address, supply all static parameters, thus:

```
NETWORK:↵
Dynamic IP: false↵
Static address: 192.168.2.2↵
Static netmask: 255.255.255.0↵
Static gateway: 192.168.2.1↵
↵
```

The parameters with the CURRENT prefix are read-only, and show the active configuration, regardless of the static or dynamic setting.

Changing the device name, or any network settings, will cause the IP connection to be dropped. The device will restart its networking and advertise its new name on the network.

Changing Monitor Settings

The display settings for each monitor are specified individually. One or more parameters can be modified at the same time and multiple settings can be supplied in one block.

The valid range for numeric values is 0-255. The CONTRAST and SATURATION properties are zero-centered, so the normal value is 127, such that the displayed picture is the same as the original. A value greater than 127 in either channel will cause the contrast or saturation to be increased, and similarly a value less than 127 will cause a decrease.

For example, to set the brightness to 50% and desaturate the image to Black & White:

```
MONITOR A:↵
Brightness: 127↵
Saturation: 0↵
↵
```

Displaying SD in 16:9

The following command sets standard definition video to display in 16:9:

```
MONITOR A:↵  
WidescreenSD: ON↵
```

Displaying SD in 4:3

The following command sets standard definition video to display in 4:3:

```
MONITOR A:↵  
WidescreenSD: OFF↵
```

Identification and Tally Settings

The Identify flag is transient, and will cause a white border to be displayed around the entire picture for a duration of 15 seconds, after which it will be reset. This feature is primarily aimed at identifying which monitor is currently being configured when it is mounted in a rack comprising multiple units.

To turn on:

```
MONITOR A:↵  
Identify: true↵  
↵
```

The IDENTIFY border will temporarily override any other border setting in effect.

The BORDER property can be used to programmatically set the soft Tally colored borders to one of the primary colors: RED, GREEN, BLUE, WHITE or NONE. This setting can be overridden by the electrical Tally signals at the DB-9 input on the device itself. For example, to set the soft Tally to green:

```
MONITOR B:↵  
Border: green↵  
↵
```

The hard wired tally will always override the soft tally. The full state report will always show the current valid border.

SmartScope Settings

On SmartScope Duo 4K, each monitor can be set to display a different scope. The values for activating specific scopes are mapped as follows:

- AudioDbfs
- AudioDbvu
- Histogram
- ParadeRGB
- ParadeYUV
- Picture (This is the same as Video Monitor)
- Vector100
- Vector75
- WaveformLuma

```
MONITOR A:↵  
ScopeMode: Picture↵  
↵
```

In the example above, Monitor A has been set as a video monitor.

Displaying SD in 16:9

The set Video Monitor mode to display standard definition video in 16:9:

```
MONITOR A:↵  
ScopeMode: Picture↵  
WidescreenSD: ON↵
```

Displaying SD in 4:3

To set Video Monitor mode to display standard definition video in 4:3:

```
MONITOR A:↵  
ScopeMode: Picture↵  
WidescreenSD: OFF↵
```

When setting one of SmartScope Duo 4K's monitors to audio metering, you can also select which channels to show. The values for selecting which audio channels are mapped in the following way:

- 0: Channels 1 and 2
- 1: Channels 3 and 4
- 2: Channels 5 and 6
- 3: Channels 7 and 8
- 4: Channels 9 and 10
- 5: Channels 11 and 12
- 6: Channels 13 and 14
- 7: Channels 15 and 16

```
MONITOR B:↵  
ScopeMode: AudioDbvu↵  
AudioChannel: 0↵  
↵
```

In the example above, Monitor B has been selected to display Audio Metering in Dbvu with audio channels 1 and 2 selected for the phase meter.

Selecting LUTs for SmartView 4K

To select 3D LUTs using SmartView 4K:

```
MONITOR A:↵  
LUT: 0 LUT 1  
1 LUT 2  
NONE DISABLE  
↵  
↵
```

Помощь

Как получить помощь

Имеется четыре способа получения помощи.

- 1** Получение дополнительной информации в центре поддержки Blackmagic Design на странице www.blackmagicdesign.com/ru.
- 2** Обращение к дилеру Blackmagic Design.
- 3** Дилеры Blackmagic Design имеют информацию обо всех обновлениях и могут оперативно оказать профессиональную помощь. Также рекомендуем проверить возможные варианты поддержки на основе вашего запроса.
- 4** Обращение с помощью формы «Отправить нам сообщение» на странице поддержки www.blackmagicdesign.com/ru/support.
- 5** Обращение в Службу поддержки Blackmagic Design. Можно также позвонить в ближайшее представительство Blackmagic Design, телефон которого вы найдете в разделе поддержки на нашем веб-сайте.

Для оперативного решения проблем заранее подготовьте техническую спецификацию и детальную информацию о возникших трудностях.

Соблюдение нормативных требований

Утилизация электрооборудования и электронной аппаратуры в Европейском Союзе



Изделие содержит маркировку, в соответствии с которой его запрещается утилизировать вместе с бытовыми отходами. непригодное для эксплуатации оборудование необходимо передать в пункт вторичной переработки. Раздельный сбор отходов и их повторное использование позволяют беречь природные ресурсы, охранять окружающую среду и защищать здоровье человека. Чтобы получить подробную информацию о порядке утилизации, обратитесь в местные муниципальные органы или к дилеру, у которого вы приобрели это изделие.



Данное оборудование протестировано по требованиям для цифровых устройств класса А (раздел 15 спецификаций FCC) и признано соответствующим всем предъявляемым критериям. Соблюдение упомянутых нормативов обеспечивает достаточную защиту от вредного излучения при работе оборудования в нежилых помещениях. Так как это изделие генерирует, использует и излучает радиоволны, при неправильной установке оно может становиться источником радиопомех. Если оборудование эксплуатируется в жилых помещениях, высока вероятность возникновения помех, влияние которых в этом случае пользователь должен устранить самостоятельно.

До эксплуатации допускаются устройства, соответствующие двум главным требованиям.

- 1 Оборудование не должно быть источником вредных помех.
- 2 Оборудование должно быть устойчивым к помехам, включая помехи, которые могут вызвать сбой в работе.

—



MSIP-REM-BMD-201410001
MSIP-REM-BMD-20150327
MSIP-REM-BMD-201702004
MSIP-REM-BMD-201702005

Соответствие требованиям ISED (Канада)

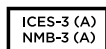

Данное оборудование соответствует канадским стандартам для цифровых устройств класса А.

Любая модификация или использование изделия не по назначению могут повлечь за собой аннулирование заявления о соответствии этим стандартам.

Подключение к HDMI-интерфейсу должно выполняться с помощью качественного экранированного кабеля.

Данное оборудование протестировано по требованиям, предъявляемым к устройствам при работе в нежилых помещениях. При использовании в бытовых условиях оно может становиться источником помех для радиосигнала.

Правила безопасности

Во избежание удара электрическим током розетка для подключения устройства к сети должна иметь заземляющий контакт. При необходимости обратитесь за помощью к квалифицированному электрику.

Чтобы минимизировать опасность поражения электрическим током, изделие необходимо защищать от попадания брызг и капель воды.

Допускается его эксплуатация в условиях тропического климата с температурой окружающей среды до 40°C.

Для работы устройства необходимо обеспечить достаточную вентиляцию.

При установке в стойку убедитесь в том, что не нарушен приток воздуха.

Внутри корпуса не содержатся детали, подлежащие обслуживанию. Для выполнения ремонтных работ обратитесь в местный сервисный центр Blackmagic Design.

Ряд оборудования позволяет установить компактный оптический SFP-модуль. Используйте только модули типа Laser class 1.

Рекомендуемые типы SFP-модулей

- **3G-SDI:** PL-4F20-311C
- **6G-SDI:** PL-8F10-311C
- **12G-SDI:** PL-TG10-311C



Допускается эксплуатация в местах не выше 2000 метров над уровнем моря.

Уведомление для жителей штата Калифорния

При работе с этим оборудованием существует возможность контакта с содержащимися в пластмассе микропримесями многобромистого бифенила, который в штате Калифорния признан канцерогеном и увеличивает риск врожденных дефектов и пороков репродуктивной системы.

Подробную информацию см. на сайте www.P65Warnings.ca.gov.

Гарантия

Ограниченная гарантия сроком 12 месяцев

Компания Blackmagic Design гарантирует отсутствие в данном изделии дефектов материала и производственного брака в течение 12 месяцев с даты продажи. Если во время гарантийного срока будут выявлены дефекты, Blackmagic Design по своему усмотрению выполнит ремонт неисправного изделия без оплаты стоимости запчастей и трудозатрат или заменит такое изделие новым.

Чтобы воспользоваться настоящей гарантией, потребитель обязан уведомить компанию Blackmagic Design о дефекте до окончания гарантийного срока и обеспечить условия для предоставления необходимых услуг. Потребитель несет ответственность за упаковку и доставку неисправного изделия в соответствующий сервисный центр Blackmagic Design с оплатой почтовых расходов. Потребитель обязан оплатить все расходы по доставке и страхованию, пошлины, налоги и иные сборы в связи с возвратом изделия вне зависимости от причины.

Настоящая гарантия не распространяется на дефекты, отказы и повреждения, возникшие из-за ненадлежащего использования, неправильного ухода или обслуживания. Компания Blackmagic Design не обязана предоставлять услуги по настоящей гарантии: а) для устранения повреждений, возникших в результате действий по установке, ремонту или обслуживанию изделия лицами, которые не являются персоналом Blackmagic Design; б) для устранения повреждений, возникших в результате ненадлежащего использования или подключения к несовместимому оборудованию; в) для устранения повреждений или дефектов, вызванных использованием запчастей или материалов других производителей; г) если изделие было модифицировано или интегрировано с другим оборудованием, когда такая модификация или интеграция увеличивает время или повышает сложность обслуживания изделия. НАСТОЯЩАЯ ГАРАНТИЯ ПРЕДОСТАВЛЯЕТСЯ КОМПАНИЕЙ BLACKMAGIC DESIGN ВМЕСТО ЛЮБЫХ ДРУГИХ ПРЯМО ВЫРАЖЕННЫХ ИЛИ ПОДРАЗУМЕВАЕМЫХ ГАРАНТИЙ. КОМПАНИЯ BLACKMAGIC DESIGN И ЕЕ ДИЛЕРЫ ОТКАЗЫВАЮТСЯ ОТ ЛЮБЫХ ПОДРАЗУМЕВАЕМЫХ ГАРАНТИЙ КОММЕРЧЕСКОЙ ЦЕННОСТИ ИЛИ ПРИГОДНОСТИ ДЛЯ КАКОЙ-ЛИБО ОПРЕДЕЛЕННОЙ ЦЕЛИ. ОТВЕТСТВЕННОСТЬ BLACKMAGIC DESIGN ПО РЕМОНТУ ИЛИ ЗАМЕНЕ НЕИСПРАВНЫХ ИЗДЕЛИЙ ЯВЛЯЕТСЯ ПОЛНЫМ И ИСКЛЮЧИТЕЛЬНЫМ СРЕДСТВОМ ВОЗМЕЩЕНИЯ, ПРЕДОСТАВЛЯЕМЫМ ПОТРЕБИТЕЛЮ В СВЯЗИ С КОСВЕННЫМИ, ФАКТИЧЕСКИМИ, СОПУТСТВУЮЩИМИ ИЛИ ПОСЛЕДУЮЩИМИ УБЫТКАМИ, ВНЕ ЗАВИСИМОСТИ ОТ ТОГО, БЫЛА ИЛИ НЕТ КОМПАНИЯ BLACKMAGIC DESIGN (ЛИБО ЕЕ ДИЛЕР) ПРЕДВАРИТЕЛЬНО ИЗВЕЩЕНА О ВОЗМОЖНОСТИ ТАКИХ УБЫТКОВ. BLACKMAGIC DESIGN НЕ НЕСЕТ ОТВЕТСТВЕННОСТИ ЗА ПРОТИВОПРАВНОЕ ИСПОЛЬЗОВАНИЕ ОБОРУДОВАНИЯ СО СТОРОНЫ ПОТРЕБИТЕЛЯ. BLACKMAGIC DESIGN НЕ НЕСЕТ ОТВЕТСТВЕННОСТИ ЗА УБЫТКИ, ВОЗНИКАЮЩИЕ ВСЛЕДСТВИЕ ИСПОЛЬЗОВАНИЯ ЭТОГО ИЗДЕЛИЯ. ПОТРЕБИТЕЛЬ ПРИНИМАЕТ НА СЕБЯ РИСКИ, СВЯЗАННЫЕ С ЕГО ЭКСПЛУАТАЦИЕЙ.

© Copyright 2020 Blackmagic Design. Все права защищены. Blackmagic Design, DeckLink, HDLink, Workgroup Videohub, Multibrige Pro, Multibrige Extreme, Intensity и "Leading the creative video revolution" зарегистрированы как товарные знаки в США и других странах. Названия других компаний и наименования продуктов могут являться товарными знаками соответствующих правообладателей.



Manuale di istruzioni

SmartView e SmartScope

Settembre 2020

Italiano



Benvenuto e benvenuta

Il nostro obiettivo è dare a ciascuno l'opportunità di accedere a dispositivi video di massima qualità, stimolando così la creatività dell'industria televisiva.

Il monitoraggio video è indispensabile in qualsiasi postazione in studio. SmartView 4K racchiude un display LCD 4K per monitorare video Ultra HD a piena risoluzione in un comodo design di 6 unità di rack, e pulsanti di controllo per cambiare impostazioni rapidamente. SmartView HD offre un ampio display LCD da 17 pollici nello spazio di 6 unità di rack con spessore di appena 2,5 cm. Nello spazio di 3 unità di rack, SmartView Duo affianca due fantastici display LCD completamente indipendenti da 8 pollici con spessore di appena 2,5 cm. SmartScope Duo 4K è dotato di due display LCD indipendenti da 8 pollici per monitorare la forma d'onda dei livelli del video a colpo d'occhio. Tutti i monitor SmartView elaborano formati SD, HD e 2K video tramite 3G-SDI. SmartScope Duo 4K e SmartView 4K supportano l'Ultra HD 4K tramite rispettivamente connessioni 6G-SDI e 12G-SDI.

Abbiamo progettato questi dispositivi di monitoraggio video per l'utilizzo immediato. Configurali con il nostro software di installazione Blackmagic SmartView Setup, semplice e intuitivo.

Questo manuale di istruzioni contiene tutte le informazioni necessarie per installare SmartView o SmartScope. Se non hai molta dimestichezza con gli indirizzi IP e le reti di computer, ti consigliamo di rivolgerti a personale esperto per ottenere assistenza tecnica. SmartView e SmartScope sono facili da installare, ma potrebbe essere necessario selezionare diverse preferenze tecniche per configurarli.

L'installazione richiede circa 5 minuti. Visita la pagina Supporto del nostro sito web su www.blackmagicdesign.com/it per scaricare l'ultima versione del manuale e del software di SmartView. Una volta scaricati gli aggiornamenti, registra i tuoi dati personali per ricevere le notifiche sugli aggiornamenti software più recenti. Blackmagic è in costante stato di innovazione. Ti invitiamo a lasciare i tuoi preziosi suggerimenti per consentirci di migliorare prestazioni e funzionalità.

Grant Petty

AD di Blackmagic Design

Indice

SmartView & SmartScope

Operazioni preliminari	325
SmartView e SmartScope	325
Collegare le fonti video	326
Collegare un computer	326
Installare Blackmagic SmartView Setup	327
Utilizzare Blackmagic SmartView Setup	328
Aggiornare il software	328
Regolare le impostazioni del monitor	328
Tally Override	331
Utilizzare SmartView 4K	331
Introduzione	331
Pulsanti di controllo	332
Caricare LUT 3D con Blackmagic SmartView Setup	334
Utilizzare SmartScope Duo 4K	335
Che cos'è Blackmagic SmartScope?	335
Monitoraggio video	336
Forma d'onda	337
Vettorscopio	338
Allineamento RGB e YUV	339
Istogramma	341
Monitoraggio audio	342
Collegarsi ad una rete	343
Connessione ethernet diretta	343
Connessione ethernet con interruttore di rete	344
Regolare le impostazioni di rete	345
Impostazioni di rete	345
Aggiungere manualmente un monitor Blackmagic alla rete	347
Utilizzare la funzione tally	348
Connettori pin della porta tally	348
Ottimizzare l'angolo di visuale	349
Informazioni per gli sviluppatori (English)	351
Blackmagic 2K Format – Overview	351
Blackmagic 2K Format – Data Stream Format	353
Blackmagic SmartView Ethernet Protocol v1.3	354
Assistenza	358
Normative	359
Sicurezza	360
Garanzia	361

Operazioni preliminari

SmartView e SmartScope

I monitor SmartView sono perfetti per il monitoraggio su rack. Per iniziare basta collegare il cavo di alimentazione e connettere la fonte video SDI. La gamma SmartView e SmartScope consiste di quattro modelli.

SmartView 4K ha un display LCD 4K da 15,6" che permette di monitorare video SD, HD, o Ultra HD alla risoluzione nativa di 3840x2160 pixel. I pulsanti di controllo sottostanti consentono di selezionare facilmente gli ingressi, regolare la luminosità dello schermo, individuare il rumore nel canale del blu, visualizzare le informazioni nei bordi dell'immagine, applicare le LUT 3D e altro ancora.

SmartView HD ha un display LCD HD da 17" perfetto per il monitoraggio a piena risoluzione HD.

SmartView Duo è dotato di due monitor per visualizzare contemporaneamente segnali video diversi. Ad esempio mentre uno mostra un segnale YUV 4:2:2, l'altro mostra un segnale RGB 4:4:4; uno il formato NTSC e l'altro il PAL. Sono possibili numerose combinazioni, e basta connettere un singolo cavo SDI ad ogni monitor per visualizzarle.

SmartScope Duo 4K ha tutte le caratteristiche di SmartView Duo e in più visualizza anche la forma d'onda, il vetterscopio, e altri visualizzatori di segnale comunemente usati per monitorare i livelli audio e video in tempo reale. Inoltre è perfettamente compatibile con il formato Ultra HD 4K.

Tutti gli ingressi dei monitor SmartView e SmartScope rilevano automaticamente i formati SD, HD o 3G-SDI, incluso il 2K. SmartView 4K rileva anche l'Ultra HD 2160p60 tramite 12G-SDI. SmartScope Duo 4K rileva automaticamente l'Ultra HD 4K tramite 6G-SDI.

Per modificare le impostazioni di più SmartView e SmartScope in modalità remota da un unico computer, connettili tra di loro tramite ethernet. In questo modo non è necessario collegare ogni singola unità a un computer con un cavo USB ogni volta che vuoi modificarne le impostazioni.

Sei arrivato alla fine della panoramica dei modelli SmartView e SmartScope. Continua a leggere il manuale per ulteriori informazioni su come connettere SmartView e SmartScope, configurare le impostazioni dei monitor con Blackmagic SmartView Setup, e collegarli ad una rete.



SmartView 4K



SmartView HD



SmartView Duo



SmartScope Duo 4K

Collegare le fonti video

I monitor SmartView e SmartScope hanno in dotazione connettori BNC standard per collegare dispositivi SDI tra cui switcher, videocamere, schede di acquisizione, deck e registratori su disco.

Visualizzare le immagini

Visualizzare il video è semplicissimo: collega il dispositivo all'alimentazione e la fonte video a un ingresso SDI. A questo punto il video dovrebbe essere immediatamente visibile. I segnali SD, HD e 2K sono automaticamente rilevati dagli ingressi SDI e dalle uscite di loop. SmartView 4K e SmartScope Duo 4K rilevano anche l'Ultra HD 4K.

Quando l'unità non riceve alcun segnale video, la retroilluminazione si spegne, garantendo risparmio energetico fino all'arrivo di un nuovo segnale.

Collegamento a cascata dei monitor

Ogni monitor SmartView e SmartScope ospita ingressi SDI indipendenti e uscite di loop, per cui è possibile collegare diversi monitor a cascata di modo che visualizzino lo stesso segnale d'ingresso:

- 1 Accendi l'unità 1. Connetti una fonte video a un ingresso SDI. Il video dovrebbe apparire immediatamente.
- 2 Accendi l'unità 2. Connetti un cavo SDI da un'uscita di loop dell'unità 1 ad un ingresso SDI nell'unità 2.

Non c'è limite al numero di unità che si possono interconnettere.

Se stai effettuando il monitoraggio della forma d'onda mediante SmartScope Duo 4K, è consigliabile connettere l'uscita del monitor 1 al monitor 2 in modo che entrambi visualizzino lo stesso segnale d'ingresso.

Ora che il video è visibile, puoi regolare le impostazioni del monitor o selezionare i visualizzatori su SmartScope Duo 4K con il software di configurazione di Blackmagic SmartView Setup, utile anche per caricare LUT 3D su Blackmagic SmartView 4K.



Collegare un computer

Per configurare le impostazioni del monitor SmartView o SmartScope, collegalo al computer tramite USB e installa Blackmagic SmartView Setup.

La connessione USB può anche essere usata per rendere effettivi gli aggiornamenti software scaricati dal sito di Blackmagic Design. Gli aggiornamenti danno accesso alle nuove funzionalità e offrono il supporto per i dispositivi e i formati di prossima generazione. Il software di configurazione Blackmagic SmartView Setup è compatibile con i computer macOS e Windows.

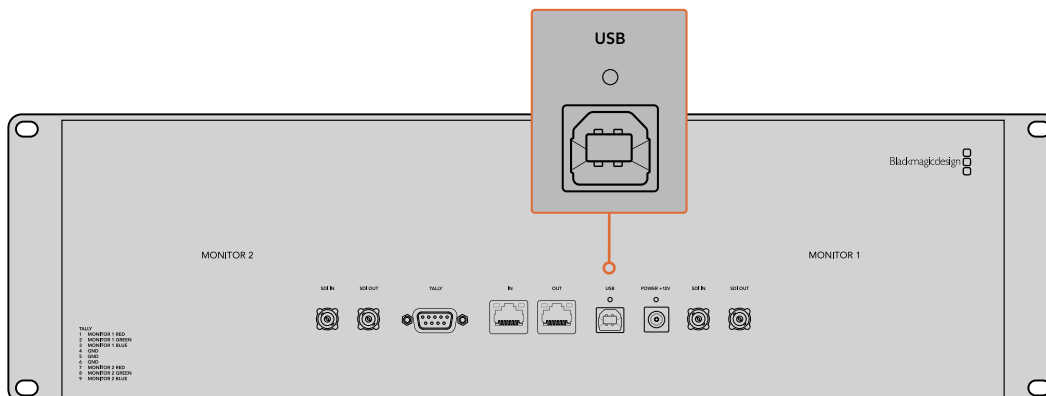

Installare Blackmagic SmartView Setup

Blackmagic SmartView Setup è compatibile con l'ultima versione di Sierra e High Sierra su macOS, e con le versioni a 64 bit su Windows 8.1 e 10 con gli ultimi service pack installati. Blackmagic SmartView Setup si può installare su più computer collegati in rete.

La scheda SD inclusa con SmartView contiene l'installer, ma suggeriamo di visitare il sito www.blackmagicdesign.com/it/support per ottenere la versione più recente.

Installazione su macOS:

Apri la scheda SD o l'immagine disco scaricata, e fai doppio clic sull'icona di installazione SmartView. Nella cartella delle applicazioni verrà creata una cartella SmartView che contiene il software SmartView Setup, un programma di disinstallazione per rimuovere le versioni precedenti quando si fa un aggiornamento, e una cartella documenti con questo manuale e altre informazioni su SmartView.

Installazione su Windows:

Apri la scheda SD o il file zip scaricato, e fai doppio clic sull'icona di installazione SmartView. Segui le istruzioni sullo schermo per completare l'installazione del software.

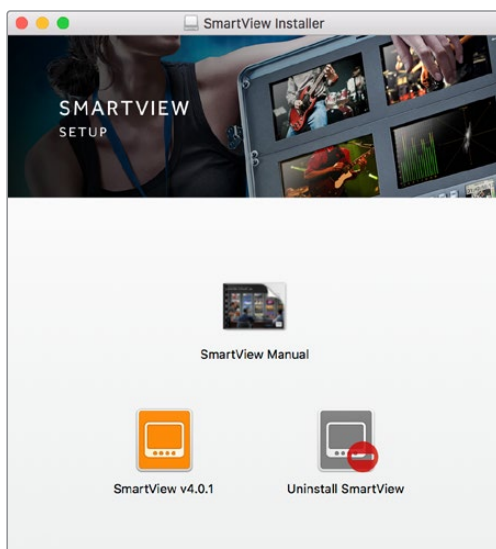

Per l'installazione su macOS, apri il file SmartView.dmg contenuto nella scheda SD, o dalla cartella dei download, e fai doppio clic sull'icona di installazione di SmartView

Utilizzare Blackmagic SmartView Setup

Aggiornare il software

Dopo aver installato e avviato Blackmagic SmartView Setup, clicca sull'icona delle impostazioni sotto il nome del tuo monitor. Potrebbe suggerirti di aggiornare il software di SmartView o SmartScope. Per farlo:

- 1 Collega SmartView o SmartScope al computer tramite USB o ethernet e lancia Blackmagic SmartView Setup.
- 2 Apparirà un avviso: clicca su **Update**. Eseguire l'aggiornamento richiede circa 5 minuti.
- 3 L'avviso *This Smartview has been updated* (SmartView è stato aggiornato) dovrebbe apparire al termine dell'aggiornamento.
- 4 Clicca su **Close**.

Se il software interno è già aggiornato all'ultima versione, la pagina impostazioni di Blackmagic SmartView Setup appare sul monitor.

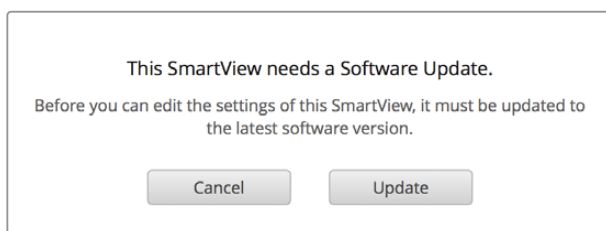

Quando lanci SmartView Setup e clicchi sull'icona delle impostazioni di SmartView o SmartScope, questo messaggio appare se è necessario aggiornare il software interno

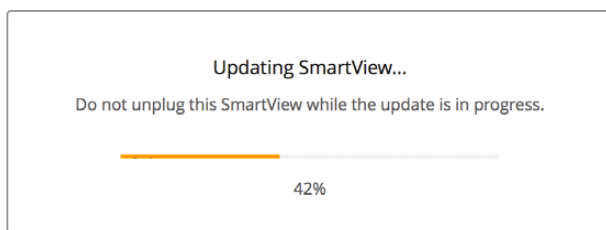

Eseguire l'aggiornamento richiede circa 5 minuti

Regolare le impostazioni del monitor

Una volta lanciato, Blackmagic SmartView Setup cerca immediatamente le unità SmartView o SmartScope collegate tramite USB o ethernet e le visualizza nella home. Se hai connesso più monitor Blackmagic alla rete, clicca sulle frecce destra e sinistra ai lati della home per selezionare quello che vuoi impostare. Se connesso tramite USB, un'icona USB appare a fianco al nome del monitor.

Per regolare le impostazioni, seleziona il monitor connesso via ethernet e USB e clicca sull'icona cartella sotto il nome del monitor. La pagina delle impostazioni del monitor selezionato si apre sullo schermo. Una volta regolati i parametri desiderati, clicca su **Save** per salvarli e tornare alla home di SmartView Setup.

Per informazioni sulle impostazioni disponibili per i monitor Blackmagic e su come applicarle, consulta la sezione successiva. Per informazioni su come configurare le impostazioni di rete utilizzando Blackmagic SmartView Setup, vai alla sezione “Regolare le impostazioni di rete”.

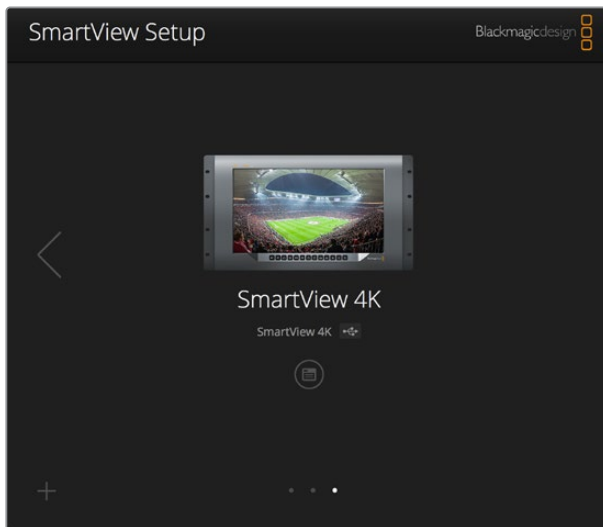

Blackmagic SmartView Setup cerca automaticamente le unità SmartView e SmartScope connesse via USB o in rete. Quando aggiorni il software interno del monitor assicurati che sia connesso tramite USB o ethernet. Un'icona USB appare di fianco al nome del monitor

Impostazioni del monitor

Per regolare le impostazioni e i visualizzatori di ogni monitor, è necessario che siano connessi tramite ethernet o USB. Seleziona il monitor che vuoi impostare cliccando sulle frecce sinistra e destra della home di SmartView Setup, quindi clicca sull'icona cartella sotto il nome del monitor interessato. La pagina delle impostazioni mostra automaticamente le opzioni relative al monitor Blackmagic selezionato.

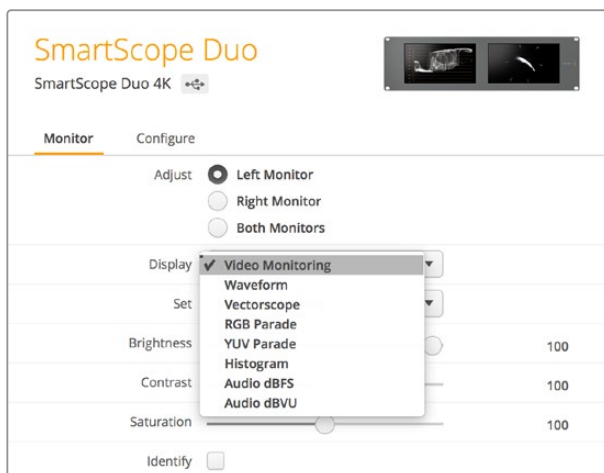

Quando usi uno SmartScope, la voce Display offre un menù a discesa per scegliere i visualizzatori tecnici o il video

Adjust

Quando usi SmartScope o SmartView Duo, scegli il monitor che vuoi regolare selezionando quello sinistro **Left Monitor**, quello destro **Right Monitor**, o entrambi **Both Monitors** allo stesso tempo. Quando è selezionata l'opzione **Both Monitors**, qualsiasi modifica alla luminosità, al contrasto e alla saturazione verrà applicata a entrambi i monitor su SmartView Duo e SmartScope.

Display

Quando usi uno SmartScope, la voce **Display** offre un menù a discesa per scegliere i visualizzatori. Se vuoi vedere solamente l'immagine del video, seleziona **Video Monitoring**.

Set

Quando usi SmartScope, il menù a discesa alla voce **Set** consente di selezionare i rapporti d'aspetto **4:3** o **16:9** per monitorare il video a definizione standard. Il menù a discesa fornisce ulteriori opzioni di visualizzazione, tra cui vettorscopio, audio dBFS e audio dBVU.

- **Video Monitoring:** scegli tra i rapporti d'aspetto 4:3 o 16:9 per visualizzare l'immagine del video.
Quando visualizzi video a definizione standard con formato anamorfico widescreen, scegli il rapporto d'aspetto **16:9**. Quando visualizzi video a definizione standard con formato tradizionale 4:3, scegli il rapporto d'aspetto **4:3**.
- **Vectorscope:** seleziona se l'input è basato su segnali di test al 100% o al 75% delle barre colore.
- **Audio dBFS:** seleziona la coppia di canali audio per il monitoraggio di fase.
- **Audio dBVU:** seleziona la coppia di canali audio per il monitoraggio di fase.

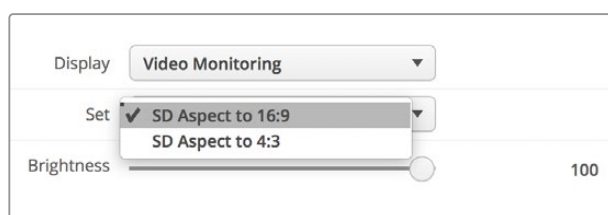

Scegli SD Aspect to 16:9 con video a definizione standard in formato anamorfico

Brightness, Contrast, Saturation

Sposta gli slider per regolare le impostazioni di luminosità **Brightness**, contrasto **Contrast** e saturazione **Saturation**. I modelli SmartView e SmartScope mostrano impostazioni diverse.

Identify

Quando la casella **Identify** è spuntata, ogni monitor selezionato da Blackmagic SmartView Setup mostra un bordo bianco. Se in rete sono connesse più unità SmartView e SmartScope, questa impostazione facilita l'identificazione visiva del monitor selezionato.

Se è utilizzata in concomitanza con l'impostazione **Both Monitors**, il bordo bianco appare sia su SmartView Duo che SmartScope Duo 4K.

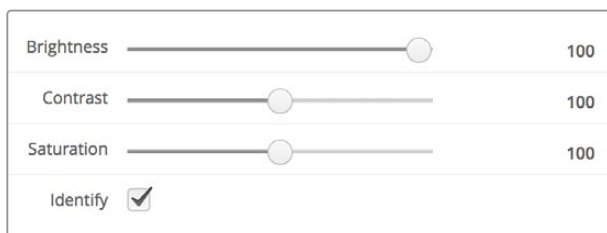

Sposta gli slider verso destra o sinistra per regolare luminosità, contrasto e saturazione. Spunta la casella Identify per facilitare l'identificazione visiva del monitor selezionato

Tally Override

Spunta **Enable tally override** per visualizzare i bordi tally su SmartView 4K, se utilizzato con Blackmagic URSA Mini Pro 4.6K e Blackmagic URSA Broadcast.

Collega l'uscita SDI della camera all'ingresso A o B di SmartView 4K.

Collega l'uscita di programma dello switcher ATEM all'ingresso SDI della camera.

SmartView 4K mostrerà un bordo tally rosso quando ATEM commuta sull'uscita di programma, o verde quando commuta sull'anteprima delle immagini della camera.

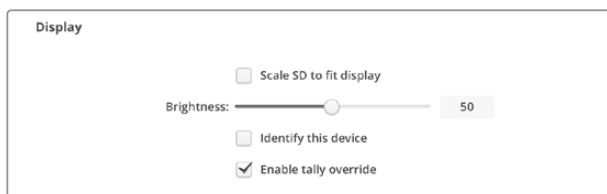

Spunta Enable tally override per visualizzare i bordi di tally su SmartView 4K quando collegato alle camere URSA Mini Pro o URSA Broadcast

Utilizzare SmartView 4K

Introduzione

SmartView 4K è un monitor broadcast Ultra HD 12G-SDI di 6 unità di rack che visualizza video SD, HD, e Ultra HD nativo fino al 2160p60. Con un display luminoso e un ampio angolo di visuale, offre immagini brillanti e nitidissime per il monitoraggio accurato della messa a fuoco e del colore, supportando virtualmente qualsiasi tipo di formato video.

Progettato per lo studio e la regia mobile, SmartView 4K è incredibilmente semplice da usare. Dotato di connettori laterali e fori di montaggio VESA, si può installare in spazi stretti, sulla parete, o su un braccio articolato. È operabile usando i pulsanti di controllo integrato o, se non hai accesso al pannello frontale, remotamente tramite ethernet.

Offre due ingressi 12G-SDI multirate che consentono di scegliere tra due sorgenti SDI, e un alloggiamento per fibra ottica SFP compatibile con lo standard SMPTE, per connettere il video tramite fibra. Trovano spazio anche un'uscita 12G-SDI per inviare il video ad altri dispositivi, e due porte ethernet per i collegamenti di rete, il controllo remoto, e il collegamento a cascata. Inoltre include un ingresso tally per la produzione dal vivo, e una porta USB per aggiornare il software interno.

Grazie al software Blackmagic SmartView Setup è possibile caricare LUT 3D professionali con estensione .cube o LUT generate in DaVinci Resolve. Una volta applicate le LUT 3D, puoi collegare SmartView 4K direttamente alla camera e vedere le clip nella versione che più si avvicina al look finale. Due livelli di focus peaking garantiscono riprese con una messa a fuoco perfetta, e gli ingressi di alimentazione AC e DC ti danno l'opzione di collegare SmartView 4K alla corrente. Oppure installa una batteria esterna per la massima mobilità sul set.

SmartView 4K è la soluzione di monitoraggio ideale per video SD, HD, e Ultra HD nella risoluzione nativa di 3840x2160 per le produzioni broadcast in studio o in esterna.



NOTA Se connetti il monitor a una fonte di alimentazione esterna tramite l'ingresso DC, assicurati che la fonte supporti 24 Watt a 12 Volt

Pulsanti di controllo

Una serie di pulsanti ti consentono di regolare rapidamente le impostazioni di SmartView 4K.

INPUT

Naviga tra i segnali video connessi ai due ingressi 12G-SDI e all'ingresso opzionale SFP per la fibra ottica. Se agli ingressi non è connesso nessun segnale, SmartView 4K mostra una schermata nera. Quando si passa da un ingresso all'altro, le informazioni sul formato di quello connesso vengono momentaneamente visualizzate nell'angolo in alto a sinistra del monitor.

DISP

Regola la luminosità dello schermo LCD di SmartView 4K. Aumenta o diminuisci i valori premendo i pulsanti freccia su e giù. Per chiudere questa impostazione premi di nuovo il pulsante DISP.

H/V DELAY

Conferma la presenza di dati ausiliari integrati nel segnale video SDI. Per esempio, premi H/V DELAY una volta per visualizzare i dati ausiliari orizzontali. Premilo di nuovo per visualizzare i dati ausiliari verticali, utilizzati comunemente per i sottotitoli chiusi.

BLUE ONLY

Se un segnale video digitale è affetto da rumore, è molto più visibile sul canale del blu. Premi BLU ONLY per verificare facilmente la presenza di rumore. Il monitor mostra il canale del blu con un'immagine in bianco e nero, utile anche per controllare la messa a fuoco della camera.

ZOOM

Per ottenere una messa a fuoco precisa delle immagini della camera basta usare il pulsante ZOOM. Premilo una volta per zoomare l'immagine, e vedere chiaramente se un oggetto è a fuoco. Premilo di nuovo per tornare alla visualizzazione normale.

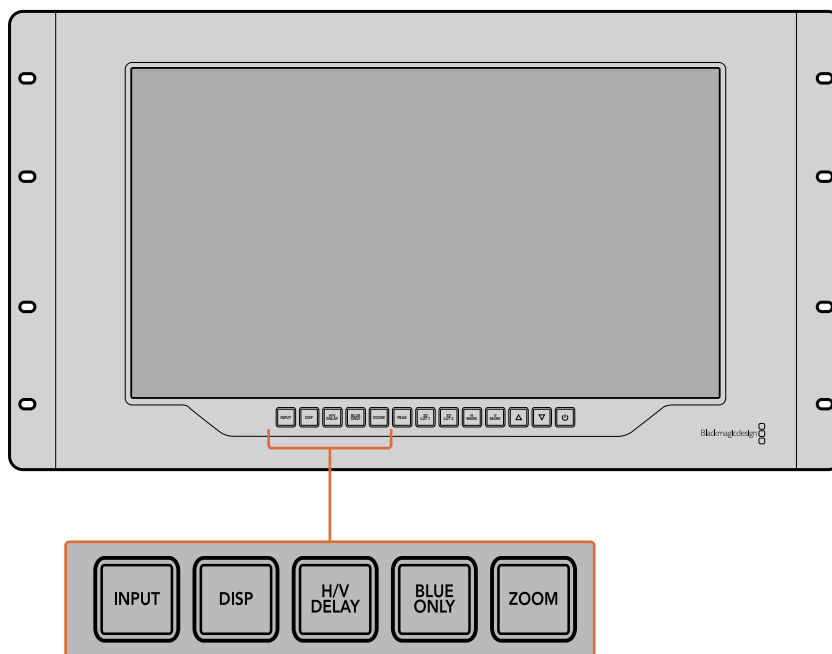

PEAK

La messa a fuoco della camera si può tenere facilmente sotto controllo premendo questo pulsante. La funzione di focus peaking mostra un contorno verde sulle alle aree più nitide dell'immagine. Ci sono due livelli di intensità di peaking, che puoi esplorare premendo ciclicamente il pulsante PEAK. Quando i contorni verdi raggiungono la massima intensità, le immagini della camera sono a fuoco.

3D LUT 1 e 3D LUT 2

Visualizza l'immagine con l'estetica delle LUT 3D personalizzate generate in DaVinci Resolve, o delle LUT di standard dell'industria .cube. Premi il pulsante LUT una volta per attivare la LUT. Premilo di nuovo per disattivarla. Per ulteriori informazioni su come adoperare le LUT 3D con SmartView 4K, consulta la sezione "Caricare LUT 3D con Blackmagic SmartView Setup".

H MARK e V MARK

Visualizza e modifica le guide di inquadratura. Le guide di inquadratura ti aiutano a comporre le riprese o a mantenere informazioni o grafica entro la safe area dello schermo. I margini del segnale video appaiono in misura diversa in base al modello di Tv, ecco perché è utile visualizzare la safe area. La safe area è una sezione dello schermo che è sempre visibile a prescindere dalla Tv o dal monitor adoperati.

Per vedere le guide di inquadratura orizzontali e verticali, premi rispettivamente i pulsanti H MARK e V MARK. Per modificare le guide, premi nuovamente i pulsanti rispettivi. Questo ti consente di riposizionare le guide utilizzando i pulsanti freccia su e giù. Conferma la nuova posizione premendo ciascun pulsante. Premili di nuovo per disattivare le guide.

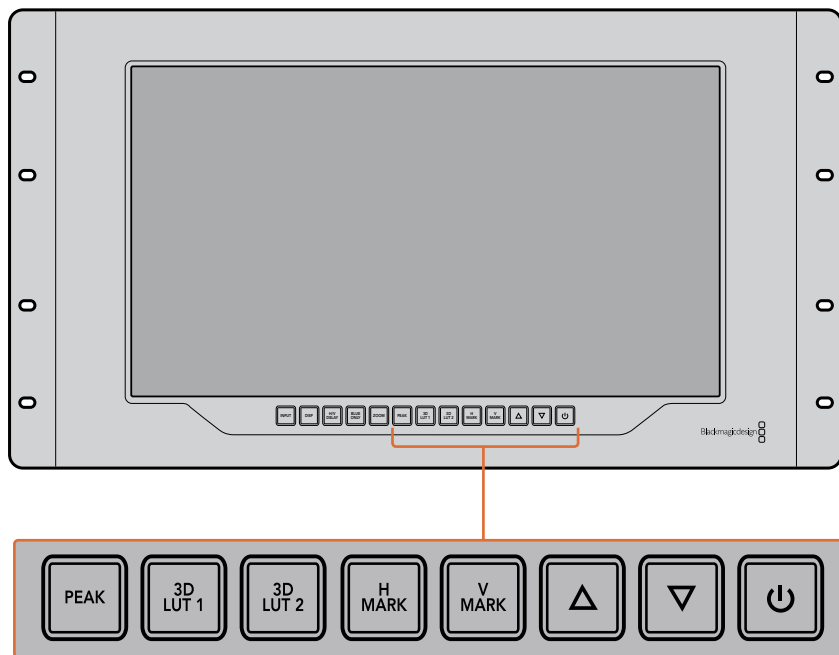

Frecce direzionali

Usa i pulsanti freccia su e giù per regolare i valori delle impostazioni, ad esempio la luminosità o la posizione delle guide di inquadratura.

Accensione

Premilo una volta per accendere SmartView 4K, e premilo nuovamente per spegnerlo.

Caricare LUT 3D con Blackmagic SmartView Setup

SmartView 4K consente di monitorare il video attraverso delle LUT 3D. Questo ti permette di calibrare SmartView 4K mediante apposite LUT professionali, o di visualizzare le immagini nella versione che più si avvicina all'estetica finale. Le LUT 3D sono utili anche per sperimentare diversi look. Per caricare le LUT su SmartView 4K basta usare Blackmagic SmartView Setup. Inoltre poiché SmartView 4K supporta LUT professionali con estensione .cube, puoi anche caricare LUT personalizzate generate in DaVinci Resolve di Blackmagic. Per ulteriori informazioni su come generare file LUT, consulta il manuale di DaVinci Resolve.

Per assegnare una LUT 3D al pulsante 3D LUT 1:

- 1** Lancia Blackmagic SmartView Setup.
- 2** Premi il pulsante **Load** alla voce **Load LUT 1**. Si aprirà una finestra che ti chiederà di indicare dove si trova il file della LUT che vuoi caricare. Seleziona il file .cube desiderato, e conferma con il pulsante **Open**.
- 3** Per vedere la LUT che hai appena caricato, premi il pulsante 3D LUT 1 sul pannello di SmartView 4K. Premi di nuovo lo stesso pulsante per disabilitarla.

Segui la stessa procedura per assegnare una LUT al pulsante 3D LUT 2.

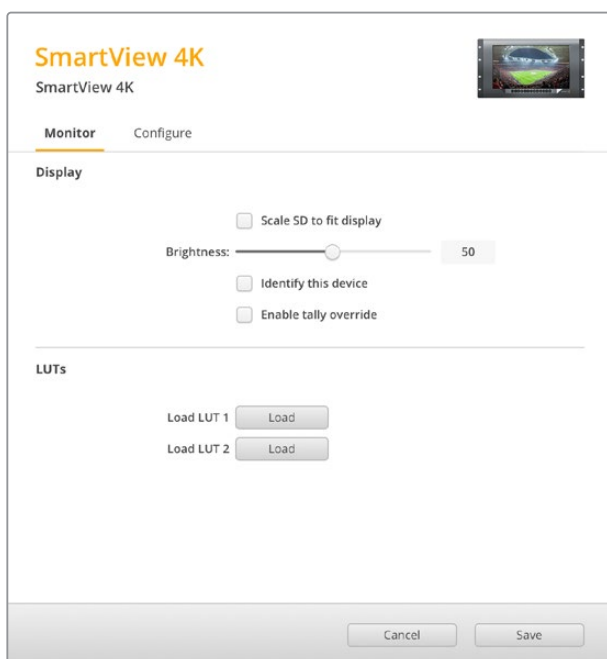

Accedi a Blackmagic SmartView Setup per caricare LUT 3D su SmartView 4K

Utilizzare SmartScope Duo 4K

Che cos'è Blackmagic SmartScope?

In passato i visualizzatori di segnale di qualità broadcast usati nell'industria televisiva in post produzione erano soluzioni su misura molto costose visualizzabili singolarmente su un piccolo schermo. Spesso hanno un design mediocre e non fanno una bella figura davanti ai clienti.

SmartScope Duo 4K include visualizzatori della forma d'onda per tenere sotto controllo ogni aspetto del segnale video su due monitor in tempo reale. Qualsiasi modifica apportata al segnale d'ingresso su Blackmagic SmartView Setup appare all'istante su SmartScope Duo 4K. Oltretutto, ogni segnale di ingresso può essere inviato ad entrambi i monitor attraverso l'uscita SDI di loop. Così facendo puoi usare il monitor destro per monitorare il segnale inviato al monitor sinistro.

I visualizzatori disponibili su SmartScope Duo 4K sono selezionabili su Blackmagic SmartView Setup dal menù a discesa alla voce **Display**.

Le sezioni seguenti approfondiscono il funzionamento di ciascun visualizzatore di segnale per aiutarti ad interpretare le informazioni.

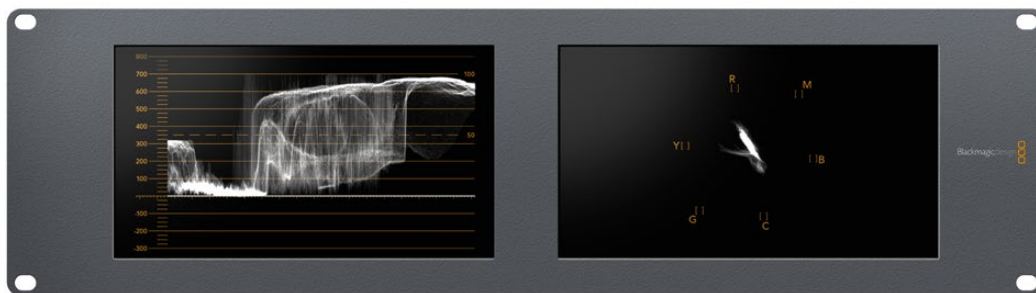

Accedi a Blackmagic SmartView Setup per scegliere i visualizzatori che vuoi monitorare sui due display di SmartScope Duo 4K

Monitoraggio video

La modalità **Video Monitoring** ti consente di visualizzare il video ricevuto da SmartScope.

Se il segnale d'ingresso è SD, nel menù a discesa alla voce **Set** puoi scegliere tra le opzioni pillarbox **4:3** o **16:9**. Il video riflette all'istante qualsiasi modifica apportata alle impostazioni di luminosità, contrasto e saturazione dello schermo LCD. Queste impostazioni interessano solo il monitor, non il segnale video, pertanto i visualizzatori non rispondono ad eventuali modifiche.

Spesso è utile visualizzare il video su un monitor e monitorare i segnali sull'altro. Per farlo, connetti l'uscita di loop SDI di "Monitor 1" all'ingresso SDI di "Monitor 2".

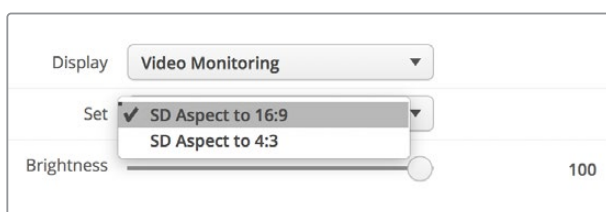

Accedi a Blackmagic SmartView Setup per selezionare tra pillarbox 4:3 e anamorfico 16:9 per il video SD. Scegli SD Aspect to 16:9 per il video a definizione standard in formato anamorfico

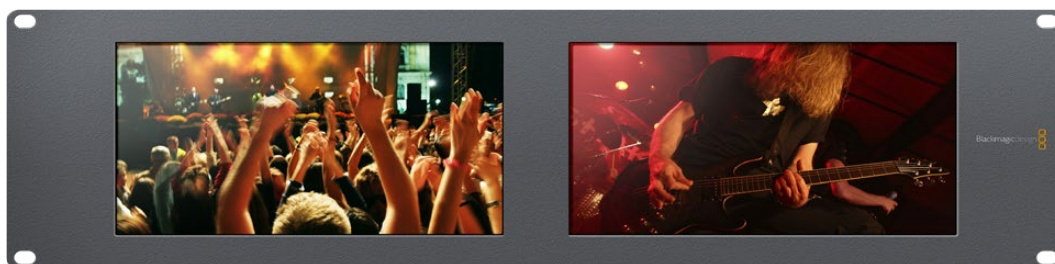

Scegli l'impostazione Video Monitoring per visualizzare le immagini come sullo schermo di una TV

Forma d'onda

Questo visualizzatore mostra una forma d'onda con codifica digitale simile a quella della luminanza tradizionale, che serve per monitorare e regolare i livelli di luma (luminosità) del segnale video.

I tradizionali visualizzatori della forma d'onda della luminanza sono compatibili solo con video analogico composito a definizione standard. SmartScope Duo 4K invece ammette Ultra HD, HD, e SD, per cui regolare i livelli di luminanza, anche in fase di monitoraggio di formati video digitali ad alta definizione, è facile e costante.

Su Blackmagic SmartView Setup, seleziona **Waveform** dal menù a discesa alla voce **Display**. Quando monitori la forma d'onda, assicurarti che i neri non scendano al di sotto dello 0% e i bianchi non superino il 100% per mantenere i livelli entro la norma.

La forma d'onda è una rappresentazione grafica dell'immagine che mostra i valori di luminanza nella stessa posizione del relativo fotogramma. Per esempio, se una parte del cielo è sovraesposta, il problema è visibile nella stessa posizione orizzontale sulla forma d'onda, proprio come nel fotogramma.

La forma d'onda varia in base alle immagini. Per esempio se stai monitorando video ad alto contrasto, i valori del grigio medio potrebbero non essere visibili. L'esempio qui sotto mostra la forma d'onda di un'immagine esposta uniformemente, con un'area scura a sinistra e aree più luminose nella zona centrale e destra del fotogramma.

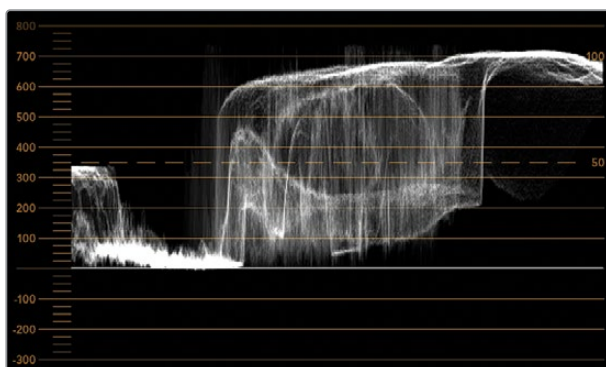

La forma d'onda mostra i valori di luminanza

Adjust	<input checked="" type="radio"/> Left Monitor
	<input type="radio"/> Right Monitor
	<input type="radio"/> Both Monitors
Display	Waveform ▼
Set	No Options ▼

Seleziona Display > Waveform su Blackmagic SmartView Setup per monitorare la luminanza del segnale video

Vettorscopio

Il vettorscopio mostra i colori di un segnale video. A seconda degli standard delle barre colore dei segnali di test utilizzati dal tuo studio, seleziona **100%** o **75%** dal menù a discesa alla voce **Set** su Blackmagic SmartView Setup.

Nota che il vettorscopio non consente di controllare i livelli fuori norma. Per questo tipo di monitoraggio bisogna ricorrere all'allineamento RGB. La ragione per cui il vettorscopio non è adatto a controllare tali livelli è che per farlo sono necessari sia i valori di luminanza che di crominanza. Ad esempio, i colori vicino al bianco o al nero nel video non possono essere saturati come i colori molto più forti, utilizzabili nei grigi medi. Poiché il vettorscopio mostra solo i colori e non i valori di luminanza, non può essere adoperato unicamente per controllare i colori fuori norma.

Il vettorscopio è lo strumento migliore per controllare i livelli di colore delle vecchie videocassette analogiche dove è necessario regolare la crominanza. Basta riprodurre il segmento delle barre colore della videocassetta e regolare le impostazioni di crominanza e tonalità per configurare i colori del video all'interno dei riquadri nel reticolo.

Il vettorscopio è anche perfetto in fase di correzione colore per verificare che il bilanciamento del bianco sia corretto, o la presenza di una tinta di colore. Se il video ha una tinta colorata, la forma slitta dal centro del grafico e potrebbero apparire due punti centrali. Normalmente il blanking del segnale video crea un punto nel centro del vettorscopio perché il blanking del video è video nero senza alcun colore. Il blanking fornisce un punto di riferimento utile per riconoscere aree di video nero senza alcuna informazione sul colore.

Se il video ha una tinta colorata, i neri si spostano dal colore e dal centro. Il grado di spostamento rappresenta la quantità di tinta di colore presente nel video, ed è visibile nei dettagli bianchi e neri. Ecco perché il vettorscopio è uno strumento prezioso per rimuovere la tinta colorata e riacquistare il corretto bilanciamento del bianco.

Il vettorscopio ti consente di spingere i colori del video al limite, senza inavvertitamente compromettere i bianchi e i neri. Il bilanciamento del bianco si può monitorare sull'allineamento RGB e sul vettorscopio, ma quest'ultimo è particolarmente indicato per controllare il bilanciamento del colore.

Quando esegui la correzione colore dell'incarnato, soprattutto dei visi, è consigliabile mantenere la saturazione dei colori caldi sulla linea diagonale che va circa dal centro alle ore 10 sul vettorscopio. Questa linea è conosciuta come "fleshtone line" e si basa sul colore del sangue sottopelle. È utile per tutti i tipi di pigmentazione della pelle, ed è il miglior modo per ottenere tonalità realistiche e naturali.

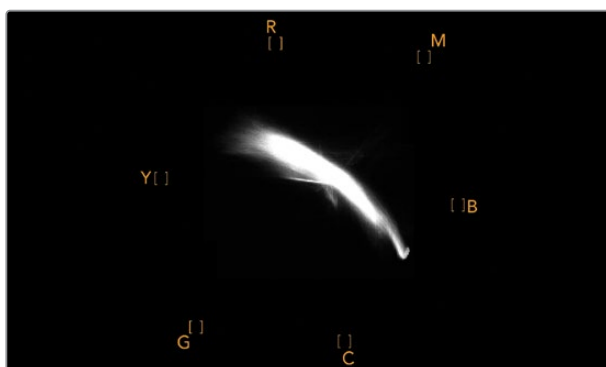

Il vettorscopio mostra la "fleshtone line" in direzione ore 10

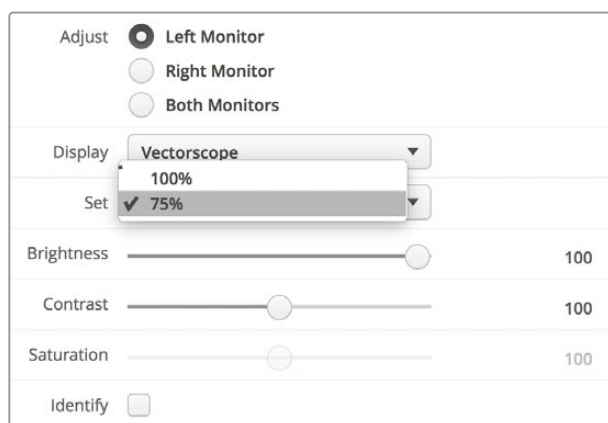

Imposta il vettroscopio su 100% o 75% per i segnali di test delle barre colore

Allineamento RGB e YUV

Gli allineamenti RGB e YUV sono ideali per controllare i livelli e mantenerli entro la norma.

Quando esegui la correzione colore, seleziona l'allineamento RGB **RGB Parade** dal menù a discesa alla voce **Display** su Blackmagic SmartView Setup. Questo visualizzatore mostra l'altezza totale dei canali del colore rosso, verde e blu. Monitorare i livelli di ogni canale di colore facilita la correzione colore e indica il bilanciamento del colore nei neri, nei mezzitoni e nei bianchi del segnale video. L'allineamento RGB ti consente di identificare i dettagli comuni nei canali del rosso, del verde e del blu, agevolando il bilanciamento del colore e la rimozione di tinte indesiderate.

Quando esegui la correzione colore, assicurati che i livelli video siano completi ma privi di clipping. Se vuoi aumentare i livelli del video, assicurati che non superino il limite RGB superiore per non andare fuori norma. Anche se alcuni dispositivi non generano livelli RGB 100% fuori norma, altri lo fanno. SmartScope Duo 4K permette di individuare i livelli fuori norma ogni volta che compaiono.

Il superamento della soglia consentita dalla norma potrebbe verificarsi anche con i livelli di bianco e di nero. In alcuni sistemi di correzione colore, i livelli di nero si possono abbassare al di sotto del punto nero dello 0%. Se i livelli di nero superano la soglia consentita, basta aumentare il lift o il gain per eliminarli, ma controlla il reticolo 100% per assicurarti che il segnale video non abbia generato colori fuori norma nei bianchi.

Per controllare i livelli YUV, seleziona **YUV Parade** dal menù a discesa alla voce **Display**. Questo visualizzatore separa i valori di luminanza da quelli di cromaticanza, ovvero il formato dei segnali video delle trasmissioni televisive. La rappresentazione grafica più a sinistra mostra le informazioni di luminanza mentre la seconda e la terza le informazioni di cromaticanza. L'allineamento YUV è utile per calibrare i valori di cromaticanza del segnale video secondo le barre colore di test, in modo che i colori siano rappresentati accuratamente e il segnale trasmesso visualizzabile su qualsiasi Tv.

La correzione colore è un processo costante di regolazione, volto ad ottenere le migliori immagini senza generare livelli fuori norma.

Terminologia correzione colore

Blacks – Livelli dei neri nel segnale video

Mids – Livelli del grigio medio nel segnale video

Whites – Livelli dei bianchi nel segnale video

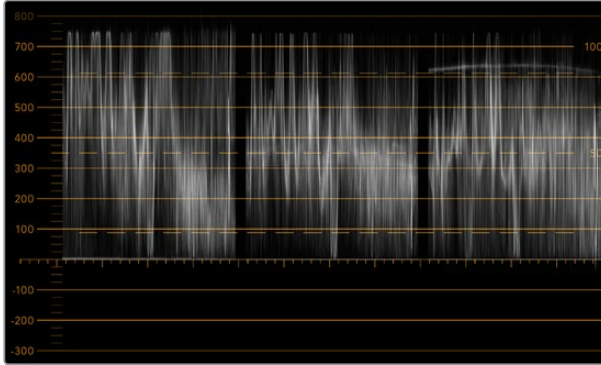

Allineamento RGB

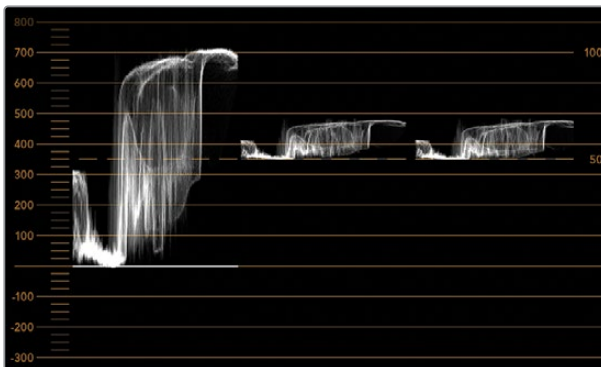

Allineamento YUV

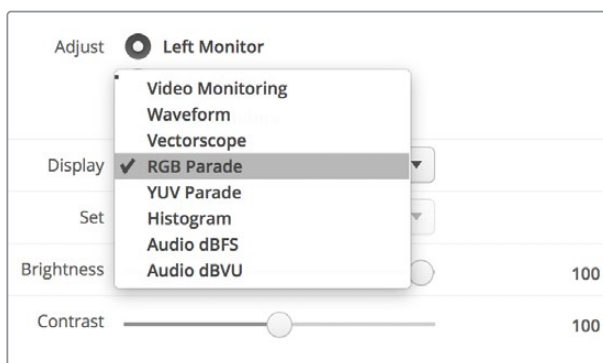

Seleziona RGB Parade o YUV Parade dal menù a discesa alla voce Display su Blackmagic SmartView Setup

Istogramma

L'istogramma è uno dei visualizzatori di segnale più usati dai grafici e dagli operatori di ripresa. Mostra la distribuzione delle informazioni dei bianchi e dei neri, aiutando a individuare i livelli a rischio di clipping, e gli effetti risultanti dai cambiamenti di gamma sulle immagini.

I neri del video sono visualizzati a sinistra del grafico, e i bianchi a destra. Solitamente ogni video dovrebbe trovarsi tra gli intervalli 0% e 100% dell'istogramma. Se il video va al di sotto dello 0% o al di sopra del 100%, è affetto da clipping. Eliminando le informazioni dei bianchi e dei neri, il clipping tende a limitare la flessibilità creativa della correzione colore in fase di post produzione. Quando giri, mantieni il video sopra la clip nera e sotto la clip bianca in modo da poter successivamente avere maggiore libertà di regolare i colori senza che i bianchi e i neri appaiano piatti o incompleti nei dettagli.

Se durante la correzione colore decidi di limitare volontariamente il segnale video, l'istogramma mostra gli effetti e la quantità di clipping. Per un risultato simile, ma con meno clipping e mantenendo maggiori dettagli, puoi regolare la gamma.

L'istogramma non è adatto a controllare i livelli fuori norma, ma consente di farlo per i bianchi e i neri. Questo strumento non mostra i colori, per cui anche se all'apparenza visualizza livelli nella norma, è possibile che il video contenga colori fuori norma. L'allineamento RGB è lo strumento migliore per monitorare i livelli fuori norma poiché li visualizza negli elementi sia del colore che della luminanza del segnale video.

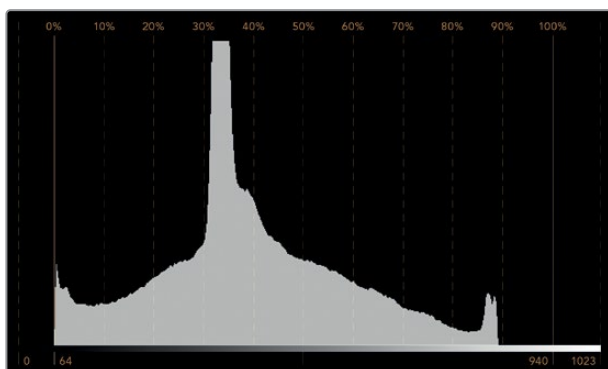

L'istogramma mostra la distribuzione dei bianchi e dei neri

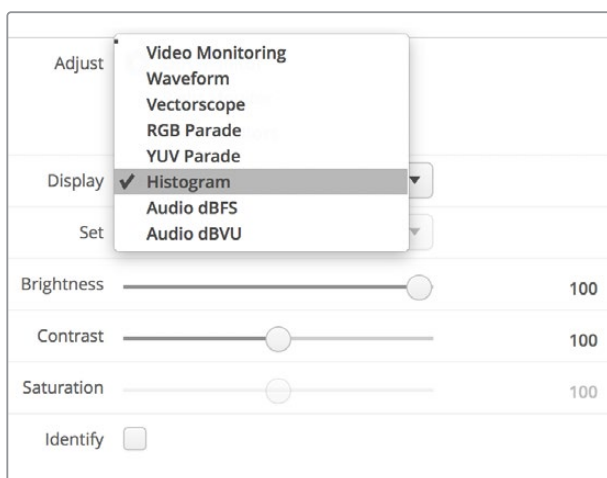

Seleziona Histogram dal menù a discesa alla voce Display su Blackmagic SmartView Setup

Monitoraggio audio

L'indicatore audio mostra i livelli dell'audio integrato nel segnale video SDI. Isola fino a 16 canali di audio integrato e li visualizza nel formato dBVU o dBFS.

L'indicatore VU mostra i livelli medi del segnale, è semplice da usare e molto comune nei dispositivi datati. Il VU è calibrato secondo la raccomandazione SMPTE di un segnale di test di tono di 1 kHz impostato su -20 dBFS.

Il dBFS è essenzialmente un indicatore del segnale audio digitale complessivo ed è comune nei moderni dispositivi digitali.

L'indicatore destro mostra coppie di canali audio, selezionabili dal menù a discesa alla voce **Set**, per esempio canale 1 e 2, 3 e 4, e così via. L'indicatore posiziona l'audio sugli assi X e Y e indica problemi di bilanciamento, condizioni di fuori fase, e se una traccia audio è mono o stereo. L'audio mono dovrebbe apparire come una singola linea verticale "in fase". Se la linea è orizzontale, l'audio è "fuori fase" e potrebbe scomparire (perdita di audio) quando viene ricevuto dai dispositivi a valle. La fase acustica è una delle falle più comuni nelle grandi strutture dove è probabile che i cavi non siano connessi correttamente.

Quando monitori i segnali stereo, la linea dell'indicatore di destra si affievolisce, a rappresentare la differenza tra i canali audio destro e sinistro. Maggiore è la quantità di suono stereo nella traccia audio e più circolare è la linea che appare. Se l'audio contiene una quantità minima di suono stereo, la forma del segnale appare concentrata intorno all'asse verticale.

I dialoghi tendono ad apparire come una linea verticale, mentre la musica ad alto contenuto stereofonico fa gonfiare la forma del segnale. Questo succede perché l'audio mono è L+R ed appare sull'asse verticale, mentre il contenuto stereo è L-R ed appare sull'asse orizzontale per indicarne la differenza.

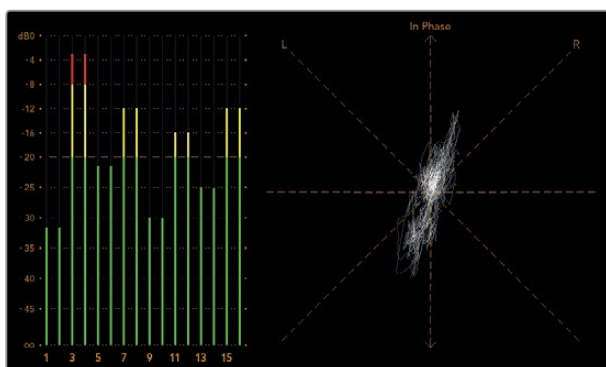

L'indicatore audio mostra il livello dei picchi e il bilanciamento audio

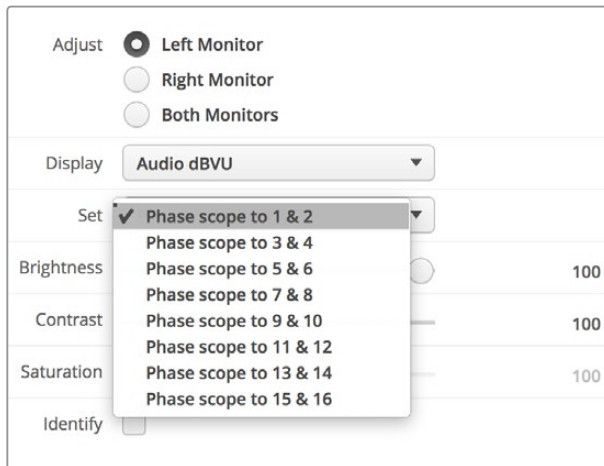

Seleziona la coppia di canali audio che vuoi monitorare dal menù a discesa alla voce Set

Collegarsi ad una rete

Collegando un monitor SmartView o SmartScope ad una rete, puoi regolare le impostazioni di più unità remotamente.

Anche se i monitor SmartView e SmartScope visualizzano il video senza bisogno di configurazione, tutte le impostazioni di rete vanno impostate prima dell'utilizzo. Per configurare le impostazioni di rete è necessario collegare il dispositivo a un computer tramite USB.

Connessione ethernet diretta

La configurazione remota del monitor può essere fatta mediante una connessione ethernet diretta al tuo computer. Non è necessario un interruttore di rete, velocizzando i tempi di installazione e impostazione. Unità aggiuntive possono essere collegate a cascata grazie alla porta ethernet di loop su ogni unità. Tutte le unità connesse devono essere collegate all'alimentazione.

Se vuoi connettere diverse unità senza usare gli indirizzi IP della rete del tuo studio, o se non hai già una rete, basta collegarle direttamente alla porta ethernet del tuo computer. Questo è un modo rapido per collegare anche SmartView e SmartScope tramite ethernet poiché non c'è bisogno di collegare cavi a interruttori di rete.

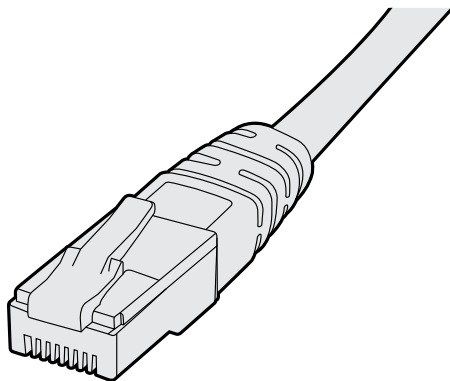

Connettore ethernet

Connessione ethernet con interruttore di rete

Se vuoi connettere più unità alla stessa rete, basta collegare solo uno SmartView o SmartScope all'interruttore di rete e collegare a cascata il resto dei monitor utilizzando la porta ethernet di loop di ciascuno. In questo modo è sufficiente una singola porta dell'interruttore, per un cablaggio semplice e ordinato. Tutte le unità devono essere collegate all'alimentazione.

Collegarsi ad un interruttore di rete consente di cambiare le impostazioni delle unità da qualsiasi computer in rete. I computer Mac o Windows permettono di farlo anche attraverso una connessione WiFi se la tua rete ha un punto d'accesso.

Per connettere SmartView o SmartScope ad una rete locale tramite IP, segui queste istruzioni:

- 1 Collega l'unità all'alimentazione.
- 2 Collega l'unità a un interruttore di rete, o direttamente al tuo computer, con un cavo ethernet RJ45 standard.

Diagramma di connessione ethernet diretta

Collega direttamente la porta ethernet di un computer all'unità, invece di ricorrere a un interruttore di rete. Unità aggiuntive si possono collegare a cascata, evitando di inserire numerosi cavi nell'interruttore di rete. Tutte le unità devono essere collegate all'alimentazione.



Diagramma di connessione ethernet con interruttore di rete

Se vuoi connettere diverse unità alla rete del tuo studio, basta collegarne una sola all'interruttore di rete. Le altre si possono collegare a cascata per cui non è necessario inserire numerosi cavi nell'interruttore di rete. Tutte le unità devono essere collegate all'alimentazione.

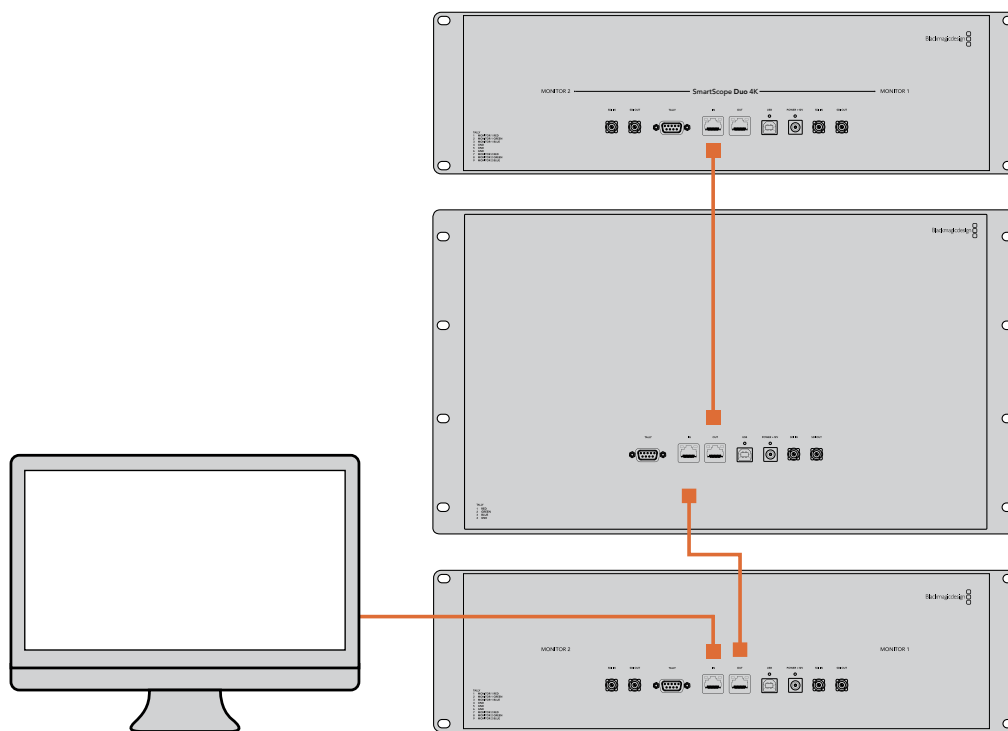
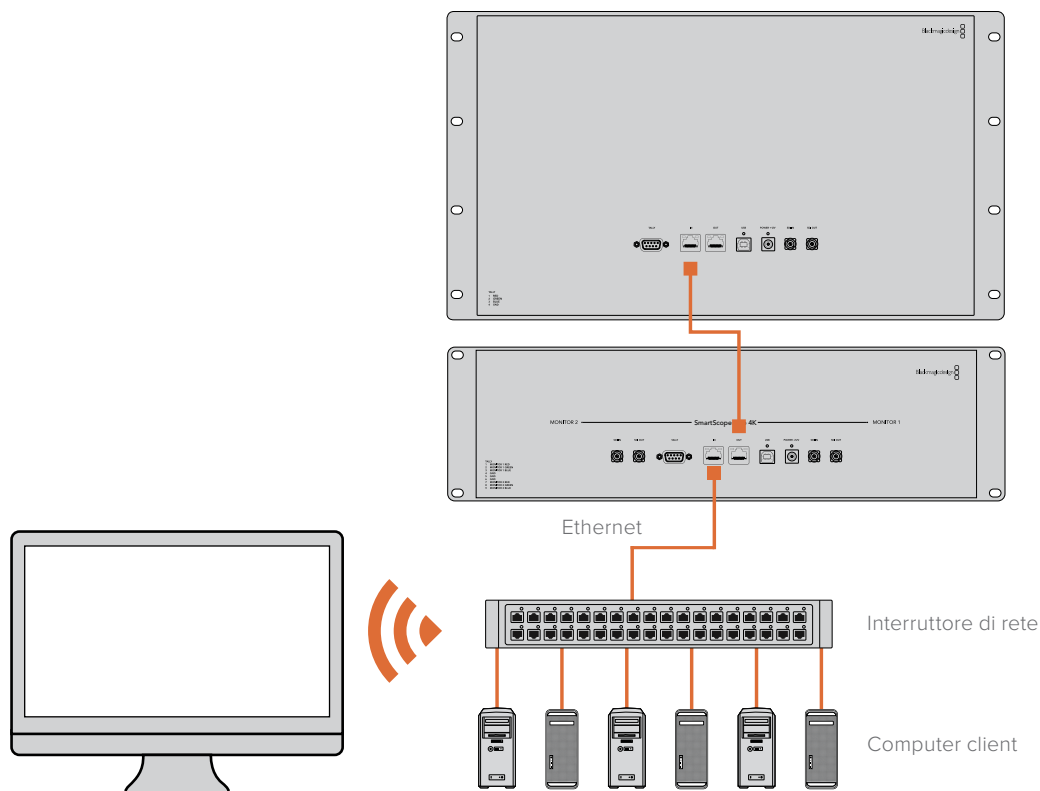

Regolare le impostazioni di rete

Impostazioni di rete

Nome dispositivo

È consigliabile cambiare il nome del dispositivo in modo che ogni unità SmartView o SmartScope sia facile da identificare in una rete, per esempio. "Camera 1 e 2", "Uscita multiview", "Feed 4K" e così via.

Per cambiare il nome del dispositivo, assicurati che sia connesso tramite ethernet o USB. Lancia Blackmagic SmartView Setup e clicca sull'icona delle impostazioni sotto il nome del monitor desiderato. Nella pagina delle impostazioni, clicca su **Network** e cambia il nome del monitor nella sezione **Details**. Se il software rileva un nome invalido, un'icona di avvertenza appare vicino al nome. Se il nome è valido, appare una spunta verde. Premi **Invio** sulla tastiera per confermare il nuovo nome.

Impostazioni di rete

Per cambiare le impostazioni di rete su Blackmagic SmartView Setup, il monitor deve essere collegato al computer tramite USB, non via ethernet.

SmartView e SmartScope usano di default DHCP per ottenere automaticamente un indirizzo IP dalla tua rete.

In assenza di un server DHCP, puoi abilitare la funzione “internet sharing” su macOS, o “internet connection sharing” (ICS) su Windows 8.1 o Windows 10, per fornire gli indirizzi DHCP ad ogni unità connessa. In questo modo si evita di dover assegnare manualmente indirizzi IP statici ad ogni unità. Puoi usare questa funzione per fornire indirizzi DHCP anche se il tuo computer non ha una connessione internet. Consulta la sezione “Help” della documentazione di macOS e Windows 8.1 e 10 per informazioni dettagliate su internet sharing.

Se la tua configurazione non ammette DHCP, usa un indirizzo IP statico. Richiedi un indirizzo IP aggiuntivo al tuo amministratore di sistema per evitare un conflitto di IP nella rete. Per ogni unità SmartView e SmartScope sarà necessario specificare un indirizzo IP unico e una maschera di sottorete condivisa. Non è necessario cambiare i valori di default del gateway a meno che non si intenda connettere le unità ad una rete gateway, ad esempio un router internet.

Se la rete non rileva nessun monitor SmartView o SmartScope, è probabile che le unità non abbiano ricevuto gli indirizzi IP tramite DHCP ed è necessario configurare manualmente ogni unità con le impostazioni di rete appropriate.

- 1 Collega il monitor SmartView o SmartScope al computer tramite USB e lancia Blackmagic SmartView Setup.
- 2 Il monitor appare automaticamente nella home di Blackmagic SmartView Setup, affiancato da un'icona USB.
- 3 Regola le impostazioni di rete del monitor.
- 4 Ripeti lo stesso procedimento per tutte le unità che non hanno ricevuto un indirizzo IP tramite DHCP.

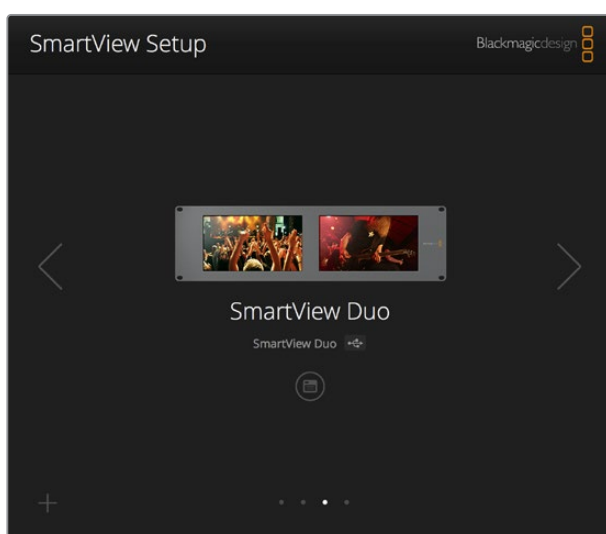

L'icona USB vicino al nome del monitor indica che l'unità è collegata al computer tramite USB. Per regolare le impostazioni di rete del monitor, è necessario connetterlo tramite USB

Le impostazioni di rete consentono di scegliere tra DHCP e un indirizzo IP statico e si possono cambiare solo tramite USB

Aggiungere manualmente un monitor Blackmagic alla rete

Se SmartView o SmartScope Duo 4K hanno già un indirizzo IP, ma non appare automaticamente nella home di Blackmagic SmartView Setup, aggiungi manualmente il monitor alla rete. Per farlo:

- 1 Assicurati che il monitor sia connesso tramite ethernet. Clicca sull'icona **+** in basso a sinistra per aprire la finestra **Add a Blackmagic monitor**.
- 2 Digita l'indirizzo IP del monitor e clicca su **Add**.
- 3 Il software ne verificherà la presenza e lo aggiungerà alla lista dei monitor connessi nella home di SmartView Setup. Clicca sulla freccia destra per vedere il monitor appena aggiunto.

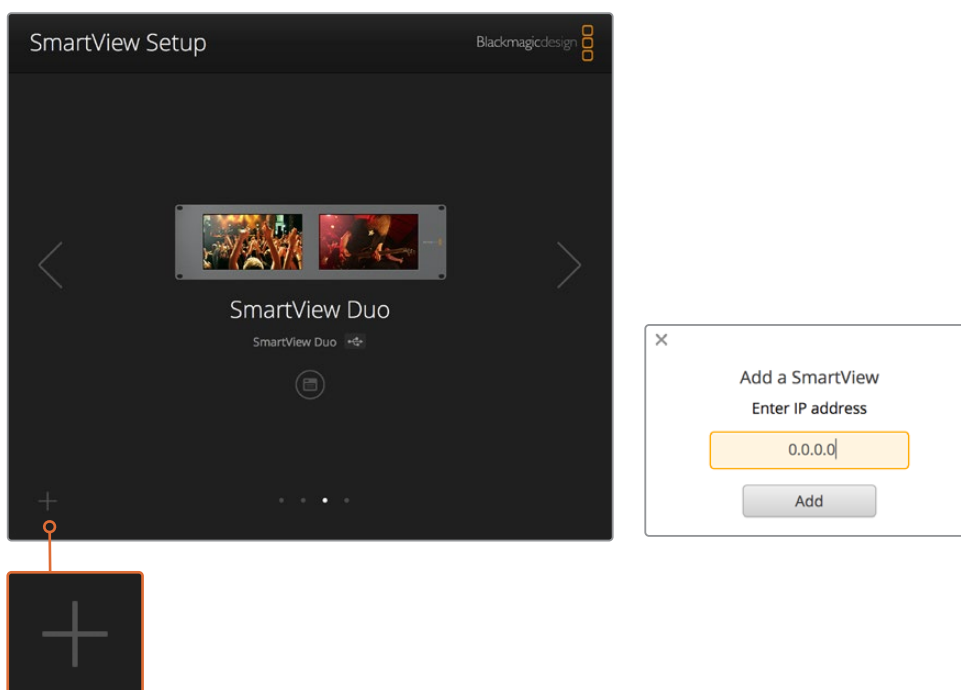

Aggiungi manualmente un monitor SmartView o SmartScope alla lista dei monitor connessi cliccando sull'icona + e inserendo l'indirizzo IP

Utilizzare la funzione tally

Connettori pin della porta tally

SmartView e SmartScope dispongono di una porta tally. Se non intendi usare questa funzione, passa direttamente alla prossima sezione.

Lo schermo di SmartView e SmartScope mostra bordi tally indipendenti in rosso, verde o blu, a indicare il segnale in onda, l'anteprima, o la registrazione.

È possibile cablare i contatti della porta tally D-sub a 9 pin direttamente da switcher e sistemi di automazione. Per informazioni su come cablare la porta tally per l'utilizzo con switcher o sistemi di automazione, consulta la tabella qui sotto.

Sul retro dell'unità trovi la descrizione dei pin della porta D per visualizzare bordi tally rosso, verde e blu sui singoli monitor.

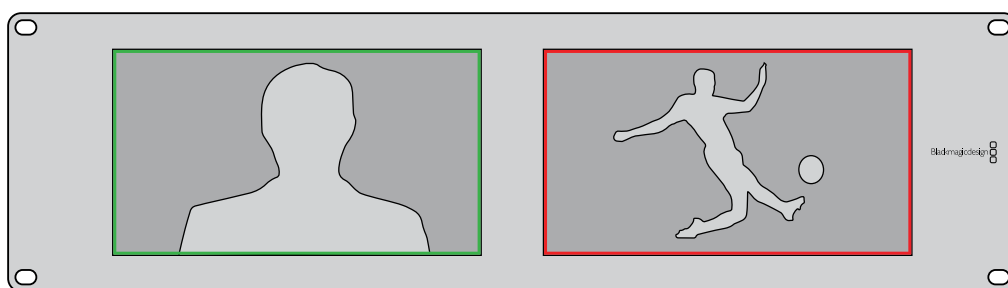

Bordi tally verde e rosso sui monitor SmartView Duo

SmartView Duo e SmartScope Duo 4K Configurazione tally	
Pin	Funzione
1	Monitor 1 Rosso
2	Monitor 1 Verde
3	Monitor 1 Blu
4	Ground
5	Ground
6	Ground
7	Monitor 2 Rosso
8	Monitor 2 Verde
9	Monitor 2 Blu

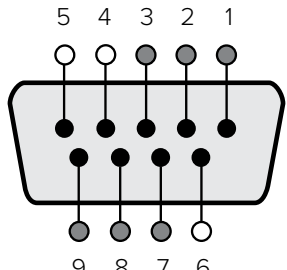

Porta tally di SmartView

SmartView HD e SmartView 4K Configurazione tally	
Pin	Funzione
1	Rosso
2	Verde
3	Blu
4	Ground

Ottimizzare l'angolo di visuale

Se installi SmartView Duo, SmartView HD o SmartScope in alto su un rack, è consigliabile invertire fisicamente gli schermi LCD per ottenere un angolo di visuale ottimale. Le immagini sugli schermi LCD ruotano automaticamente nella posizione corretta in base al movimento rilevato. Per smontare e rimontare la placca dal retro del dispositivo è necessario un cacciavite Pozidriv 2. Si tratta di una procedura semplice che non richiede l'apertura del vano posteriore.

Le istruzioni qui sotto spiegano come invertire l'unità mantenendo il logo Blackmagic Design nella direzione corretta sulla placca. È necessario un cacciavite Pozidriv 2.

- 1 Rimuovi le viti dal lato superiore, inferiore, destro e sinistro della placca. SmartView Duo e SmartScope Duo 4K hanno 10 viti; SmartView HD ne ha 18.
- 2 Solleva la placca dal retro del dispositivo come illustrato sotto.
- 3 Inverti il retro del dispositivo.
- 4 Reinserisci la placca sul retro del dispositivo invertito.
- 5 Reinserisci le viti precedentemente rimosse.

Ora puoi installare SmartView o SmartScope sul rack. Una volta avvitato sul rack, SmartView continua a visualizzare l'angolo ottimale anche se viene urtato poiché non ci sono manopole esterne o controlli esposti.



Prima di avvitare l'unità sul rack, è consigliabile eseguire un'inversione di prova per assicurarsi che l'angolo di visuale sia ottimale

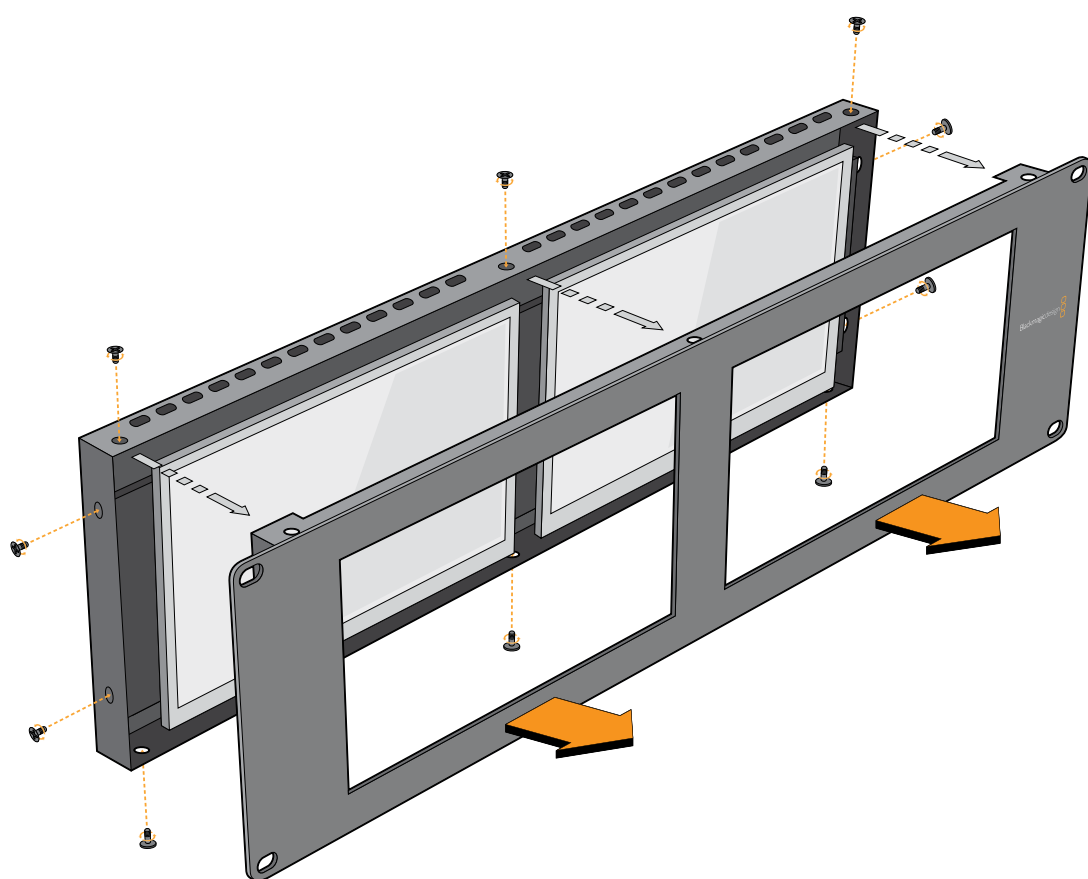

Rimuovi tutte le viti per sollevare la placca frontale dal retro del dispositivo

Informazioni per gli sviluppatori (English)

Developing Custom Software Using Blackmagic Design Hardware

The Blackmagic SmartView Ethernet Protocol allows developers to remotely control Blackmagic SmartView and SmartScope hardware with their own custom software. The Blackmagic SmartView Ethernet Protocol is a text-based status and control protocol.

Downloading the Free SmartView Ethernet Protocol

The Blackmagic SmartView Ethernet Protocol is free. It is included in this SmartView & SmartScope manual and can be downloaded from www.blackmagicdesign.com/it/support

Joining the Blackmagic Design Developer List

The Blackmagic Developer mailing list is designed for technical questions regarding technologies used by Blackmagic Design, e.g., QuickTime, Core Media, DirectShow, codecs, APIs, SDKs, etc. The free mailing list is a forum where developers can discuss ideas and problems with other developers. Any subscriber may reply and the Blackmagic Design engineers may also respond when appropriate. You can subscribe to the mailing list at: <http://lists.blackmagicdesign.com/mailman/listinfo/bmd-developer>

In some cases, we might request a brief outline of the software you are developing if it is not immediately obvious from your domain name that your organization develops video software. Please don't take offence as we're simply trying to keep the list free of spam and viruses as well as end-user customers asking non-development questions, employment agents or sales people trying to promote products on the list. The list is just for developers.

Contacting Blackmagic Design Developer Assistance

You can also contact us via developer@blackmagicdesign.com if you have any developer related questions or wish to ask questions off the list.



Blackmagic 2K Format – Overview

Blackmagic Design products support 3G-SDI video, which allows twice the data rate of traditional HD-SDI video. We thought it would be a really nice idea to add 2K film support, via 3G-SDI technology, so we could simplify feature film workflows. With the popularity of Blackmagic Design editing systems worldwide, now thousands of people can benefit from a feature film workflow revolution.

This information includes everything product developers need to know for building native 2K SDI equipment. Of course, all Blackmagic products can be updated, so if the television industry adopts an alternative SDI-based film standard, we can add support for that too!

Frame Structure

- Transmitted at 23.98, 24 or 25 frames per second as a Progressive Segmented Frame.
- Active video is 2048 pixels wide by 1556 lines deep.
- Total lines per frame : 1650
- Active words per line are 1535. One word consists of a 10-bit sample for each of the four data streams, i.e., a total of 40 bits. See the diagram named Blackmagic 2K Format - Data Stream Format.
- Total active lines : 1556
- Total words per line : 1875 for 23.98/24Hz and 1800 for 25Hz.
- Fields per frame : 2, 825 lines each
- Active lines located on lines 16-793 (field 1) and 841-1618 (field 2).

Transport Structure

- Based on SMPTE 372M Dual Link mapping and SMPTE 425M-B support for mapping SMPTE 372M into a single 3 Gb/s link.
- Timing reference signals, line number and line CRC insertion is the same as above.
- During active video, 10-bit Red, Green and Blue data is sent in the following sequence:
- Optional ancillary data is inserted into both virtual interfaces.
- At present, only audio data is included: as per standard HD audio insertion (SMPTE S299M) the audio data packets are carried on data stream two and audio control packets are carried on data stream one.
 - Data stream 1: Green_1, Green_2, Green_3, Green_5...Green_2047
 - Data stream 2: Blue_1, Blue_2, Green_4, Blue_5...Green_2048.
 - Data stream 3: Red_1, Blue_3, Blue_4, Red_5...Blue_2048.
 - Data stream 4: Red_2, Red_3, Red_4, Red_6...Red_2048.

Blackmagic 2K Format – Vertical Timing Reference

This diagram shows the vertical timing details with line numbers and Field, Vertical and Horizontal bits for the Timing Reference Signal codes.

		Field 1					Active					
F	1	0	0	0	0	0	0	0	0	0	0	0
V	1	1	1	1	1	1	0	0	0	0	1	1
LINE #	1650	1	2	...	14	15	16	...	792	793	...	825

		Field 2					Active					
F	0	1	1	1	1	1	1	1	1	1	1	1
V	1	1	1	1	1	1	0	0	0	0	1	1
LINE #	825	826	827	...	839	840	841	...	1617	1618	...	1650

Blackmagic 2K Format – Data Stream Format

This diagram shows the data stream formats around the optional ancillary data section of the horizontal line. Note that each active pixel takes up three samples.

Word# 25 PsF	Word# 23.98/24 PsF	Data Stream 4	Data Stream 3	Data Stream 2	Data Stream 1
1795	1870	R2042	R2041	B2041	G2041
1796	1871	R2043	B2043	B2042	G2042
1797	1872	R2044	B2044	G2044	G2043
1798	1873	R2046	R2045	B2045	G2045
1799	1874	R2047	B2047	B2046	G2046
1800	1875	R2048	B2048	G2048	G2047
1	1	EAV(3FFh)	EAV(3FFh)	EAV(3FFh)	EAV(3FFh)
2	2	EAV(000h)	EAV(000h)	EAV(000h)	EAV(000h)
3	3	EAV(000h)	EAV(000h)	EAV(000h)	EAV(000h)
4	4	EAV(XYZh)	EAV(XYZh)	EAV(XYZh)	EAV(XYZh)
5	5	LN0	LN0	LN0	LN0
6	6	LN1	LN1	LN1	LN1
7	7	CRC0	CRC0	CRC0	CRC0
8	8	CRC1	CRC1	CRC1	CRC1
9	9	200	040	ANC/Audio Data	ANC/Audio Data
...		
260	335	200	040		
261	336	SAV(3FFh)	SAV(3FFh)	SAV(3FFh)	SAV(3FFh)
262	337	SAV(000h)	SAV(000h)	SAV(000h)	SAV(000h)
263	338	SAV(000h)	SAV(000h)	SAV(000h)	SAV(000h)
264	339	SAV(XYZh)	SAV(XYZh)	SAV(XYZh)	SAV(XYZh)
265	340	R2	R1	B1	G1
266	341	R3	B3	B2	G2
267	342	R4	B4	G4	G3
268	343	R6	R5	B5	G5

Blackmagic SmartView Ethernet Protocol v1.3

Summary

The Blackmagic SmartView Ethernet Protocol is a text-based status and control protocol, very similar in structure to the Videohub protocol, that is accessed by connecting to TCP port 9992 on a SmartView or SmartScope device.

Upon connection, the SmartView or SmartScope device sends a complete dump of the state of the device. After the initial dump, state changes are sent asynchronously.

The device sends information in blocks which have an identifying header, followed by a colon. A block can span multiple lines and is terminated by a blank line.

To be resilient to future protocol changes, clients should ignore blocks they do not recognize, up to the trailing blank line. Within recognized blocks, clients should ignore lines they do not recognize.

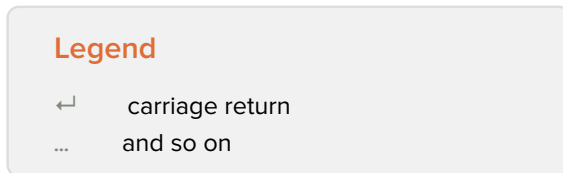

Version 1.3 of the Blackmagic SmartView Ethernet Protocol was released with SmartView 1.3 software.

Protocol Preamble

The first block sent by the SmartView Server is always the protocol preamble:

```
PROTOCOL PREAMBLE:↵
Version: 1.3 ↵
↵
```

The version field indicates the protocol version. When the protocol is changed in a compatible way, the minor version number will be updated. If incompatible changes are made, the major version number will be updated.

Device Information

The next block contains general information about the connected SmartView or SmartScope device.

```
SMARTVIEW DEVICE:↵
Model: SmartView Duo↵
Hostname: stagefront.studio.example.com↵
Name: StageFront↵
Monitors: 2↵
Inverted: false↵
↵
```

This example shows the output for a SmartView Duo device, which has two LCDs. The INVERTED flag indicates whether the device has detected that it has been mounted in an inverted configuration to optimize LCD viewing angle.

Network Configuration

The next block shows the TCP/IP networking configuration:

```
NETWORK:↵
Dynamic IP: true↵
Static address: 192.168.2.2↵
Static netmask: 255.255.255.0↵
Static gateway: 192.168.2.1↵
Current address: 192.168.1.101↵
Current netmask: 255.255.255.0↵
Current gateway: 192.168.1.1↵
↵
```

The network settings prefixed with CURRENT show the active TCP/IP settings, and are read-only. The CURRENT settings reflect either the DHCP or Static configuration, depending on the DYNAMIC IP flag.

Changing Networking Settings

The network can be configured to use either DHCP or a static configuration. To enable DHCP:

```
NETWORK:↵
Dynamic IP: true↵
↵
```

To set a fixed IP address, supply all static parameters, thus:

```
NETWORK:↵
Dynamic IP: false↵
Static address: 192.168.2.2↵
Static netmask: 255.255.255.0↵
Static gateway: 192.168.2.1↵
↵
```

The parameters with the CURRENT prefix are read-only, and show the active configuration, regardless of the static or dynamic setting.

Changing the device name, or any network settings, will cause the IP connection to be dropped. The device will restart its networking and advertise its new name on the network.

Changing Monitor Settings

The display settings for each monitor are specified individually. One or more parameters can be modified at the same time and multiple settings can be supplied in one block.

The valid range for numeric values is 0-255. The CONTRAST and SATURATION properties are zero-centered, so the normal value is 127, such that the displayed picture is the same as the original. A value greater than 127 in either channel will cause the contrast or saturation to be increased, and similarly a value less than 127 will cause a decrease.

For example, to set the brightness to 50% and desaturate the image to Black & White:

```
MONITOR A:↵
Brightness: 127↵
Saturation: 0↵
↵
```

Displaying SD in 16:9

The following command sets standard definition video to display in 16:9:

```
MONITOR A:↵  
WidescreenSD: ON↵
```

Displaying SD in 4:3

The following command sets standard definition video to display in 4:3:

```
MONITOR A:↵  
WidescreenSD: OFF↵
```

Identification and Tally Settings

The Identify flag is transient, and will cause a white border to be displayed around the entire picture for a duration of 15 seconds, after which it will be reset. This feature is primarily aimed at identifying which monitor is currently being configured when it is mounted in a rack comprising multiple units. To turn on:

```
MONITOR A:↵  
Identify: true↵  
↵
```

The IDENTIFY border will temporarily override any other border setting in effect.

The BORDER property can be used to programmatically set the soft Tally colored borders to one of the primary colors: RED, GREEN, BLUE, WHITE or NONE. This setting can be overridden by the electrical Tally signals at the DB-9 input on the device itself. For example, to set the soft Tally to green:

```
MONITOR B:↵  
Border: green↵  
↵
```

The hard wired tally will always override the soft tally. The full state report will always show the current valid border.

SmartScope Settings

On SmartScope Duo 4K, each monitor can be set to display a different scope. The values for activating specific scopes are mapped as follows:

- AudioDbfs
- AudioDbvu
- Histogram
- ParadeRGB
- ParadeYUV
- Picture (This is the same as Video Monitor)
- Vector100
- Vector75
- WaveformLuma

```
MONITOR A:↵  
ScopeMode: Picture↵  
↵
```

In the example above, Monitor A has been set as a video monitor.

Displaying SD in 16:9

The set Video Monitor mode to display standard definition video in 16:9:

```
MONITOR A:↵  
ScopeMode: Picture↵  
WidescreenSD: ON↵
```

Displaying SD in 4:3

To set Video Monitor mode to display standard definition video in 4:3:

```
MONITOR A:↵  
ScopeMode: Picture↵  
WidescreenSD: OFF↵
```

When setting one of SmartScope Duo 4K's monitors to audio metering, you can also select which channels to show. The values for selecting which audio channels are mapped in the following way:

- 0: Channels 1 and 2
- 1: Channels 3 and 4
- 2: Channels 5 and 6
- 3: Channels 7 and 8
- 4: Channels 9 and 10
- 5: Channels 11 and 12
- 6: Channels 13 and 14
- 7: Channels 15 and 16

```
MONITOR B:↵  
ScopeMode: AudioDbvu↵  
AudioChannel: 0↵  
↵
```

In the example above, Monitor B has been selected to display Audio Metering in Dbvu with audio channels 1 and 2 selected for the phase meter.

Selecting LUTs for SmartView 4K

To select 3D LUTs using SmartView 4K:

```
MONITOR A:↵  
LUT: 0 LUT 1  
    1 LUT 2  
    NONE    DISABLE  
↵  
↵
```

Assistenza

Assistenza clienti

Ci sono quattro opzioni per ricevere assistenza

- 1 Visita www.blackmagicdesign.com/it/support per le note di supporto più recenti.
- 2 Contatta il tuo rivenditore Blackmagic Design per gli aggiornamenti tecnici Blackmagic Design più recenti e per ottenere assistenza immediata. I rivenditori ti forniscono opzioni di assistenza su misura in base alle esigenze del tuo flusso di lavoro.
- 3 Inviaci un'email con le tue domande cliccando su **Invia una email** sulla pagina www.blackmagicdesign.com/it/support
- 4 Chiama uno dei centri assistenza Blackmagic Design. Per trovare quello più vicino a te, clicca su **Trova un team di supporto** in basso alla pagina Supporto.

Ti preghiamo di fornirci informazioni dettagliate in merito ai problemi tecnici e alle specifiche di sistema per consentirci di risolvere il problema nel minor tempo possibile.

Normative

Smaltimento di apparecchiature elettriche ed elettroniche nell'Unione Europea



Questo simbolo indica che il dispositivo non deve essere scartato insieme agli altri rifiuti, ma consegnato a uno degli appositi centri di raccolta e riciclaggio. La raccolta e lo smaltimento differenziato corretto di questo tipo di apparecchiatura evita lo spreco di risorse e contribuisce alla sostenibilità ambientale e umana. Per tutte le informazioni sui centri di raccolta e riciclaggio, contatta gli uffici del tuo comune di residenza o il punto vendita presso cui hai acquistato il prodotto.



Questo dispositivo è stato testato, e dichiarato conforme ai limiti relativi ai dispositivi digitali di Classe A, ai sensi dell'articolo 15 del regolamento FCC. Tali limiti sono stati stabiliti con lo scopo di fornire protezione ragionevole da interferenze dannose in ambienti commerciali. Questo dispositivo genera, usa e può irradiare energia a radiofrequenza e, se non è installato o usato in conformità alle istruzioni, può causare interferenze dannose che compromettono le comunicazioni radio. Operare questo dispositivo in ambienti residenziali può causare interferenze dannose, nella cui evenienza l'utente dovrà porvi rimedio a proprie spese.

Il funzionamento è soggetto alle due condizioni seguenti:

- 1 Questo dispositivo non deve causare interferenze dannose.
- 2 Questo dispositivo deve accettare eventuali interferenze ricevute, incluse le interferenze che possono causare un funzionamento indesiderato.

—



MSIP-REM-BMD-201410001
MSIP-REM-BMD-20150327
MSIP-REM-BMD-201702004
MSIP-REM-BMD-201702005

Dichiarazione ISED (Canada)

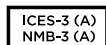

Questo dispositivo è conforme agli standard canadesi sui dispositivi digitali di Classe A.

Qualsiasi modifica o utilizzo del dispositivo al di fuori di quello previsto potrebbe invalidare la conformità a tali standard.

Connettere le interfacce HDMI usando cavi schermati HDMI di alta qualità.

Questo dispositivo è stato testato per l'uso in ambienti commerciali. Se utilizzato in ambienti domestici, può causare interferenze radio.

Sicurezza

Per evitare scosse elettriche, connettere il dispositivo a una presa di corrente con messa a terra. Per qualsiasi dubbio, contattare un elettricista qualificato.

Per ridurre il rischio di scosse elettriche, evitare di esporre il dispositivo a gocce o spruzzi.

Questo dispositivo è adatto all'uso nei luoghi tropicali con una temperatura ambiente non superiore ai 40°C.

Lasciare uno spazio adeguato intorno al dispositivo per consentire sufficiente ventilazione.

Se installato su rack, assicurarsi che i dispositivi adiacenti non ostacolino la ventilazione.

Le parti all'interno del dispositivo non sono riparabili dall'utente. Contattare il centro Blackmagic Design più vicino

per i servizi di manutenzione.

Alcuni dispositivi ospitano una porta per connettere ricetrasmittitori ottici SFP. Usare solo moduli SFP Laser, Class 1.

Moduli SFP consigliati da Blackmagic Design:

- **3G-SDI:** PL-4F20-311C
- **6G-SDI:** PL-8F10-311C
- **12G-SDI:** PL-TG10-311C



Usare il dispositivo a un'altitudine non superiore a 2000 m sopra il livello del mare.

Dichiarazione dello Stato della California

Questo dispositivo può esporre l'utente a sostanze chimiche, per esempio tracce di bifenili polibromurati nelle parti in plastica, che nello Stato della California sono considerati causa di cancro e difetti alla nascita o altri danni al sistema riproduttivo.

Per maggiori informazioni, visitare la pagina www.P65Warnings.ca.gov.

Garanzia

Garanzia limitata di un anno

Blackmagic Design garantisce che questo prodotto è fornito privo di difetti nei materiali e nella manifattura per un periodo di un anno a partire dalla data d'acquisto. Durante il periodo di garanzia Blackmagic Design riparerà o, a sua scelta, sostituirà tutti i componenti che risultino difettosi esonerando il Cliente da costi aggiuntivi, purché i componenti vengano restituiti dal Cliente.

Per ottenere l'assistenza coperta dalla presente garanzia, il Cliente deve notificare Blackmagic Design del difetto entro il periodo di garanzia. Il Cliente è responsabile del costo di imballaggio e di spedizione del prodotto al centro di assistenza indicato da Blackmagic Design, con spese di spedizione prepagate. Il costo include spedizione, assicurazione, tasse, dogana, e altre spese pertinenti alla resa del prodotto a Blackmagic Design.

Questa garanzia perde di validità per danni causati da utilizzo improprio, o da manutenzione e cura inadeguate del prodotto. Blackmagic Design non ha obbligo di assistenza e riparazione sotto garanzia per danni al prodotto risultanti da: a) precedenti tentativi di installazione, riparazione o manutenzione da personale non autorizzato, ovvero al di fuori del personale Blackmagic Design, b) precedenti usi impropri o tentativi di connessione ad attrezzatura incompatibile al prodotto, c) precedente uso di parti o ricambi non originali Blackmagic Design, o d) precedenti modifiche o integrazione del prodotto ad altri prodotti, con il risultato di rendere la riparazione più difficoltosa o di allungare le tempistiche di eventuali ispezioni atte alla riparazione. LA PRESENTE GARANZIA DI BLACKMAGIC DESIGN SOSTITUISCE QUALSIASI ALTRA GARANZIA, ESPLICITA O IMPLICITA. BLACKMAGIC DESIGN E I SUOI FORNITORI ESCLUDONO QUALSIASI ALTRA GARANZIA IMPLICITA DI COMMERCIALIZZABILITÀ O DI IDONEITÀ AD UN USO SPECIFICO. L'INTERA RESPONSABILITÀ DI BLACKMAGIC DESIGN E L'UNICO ESCLUSIVO RICORSO DELL'UTENTE PER QUALSIASI DANNO ARRECATO DI NATURA INDIRETTA, SPECIFICA, ACCIDENTALE O CONSEGUENZIALE, ANCHE QUALORA BLACKMAGIC DESIGN FOSSE STATA AVVERTITA DELLA POSSIBILITÀ DI TALI DANNI, È LA RIPARAZIONE O LA SOSTITUZIONE DEI PRODOTTI DIFETTOSI. BLACKMAGIC DESIGN NON SI ASSUME ALCUNA RESPONSABILITÀ PER QUALSIASI USO ILLEGALE DEL DISPOSITIVO DA PARTE DEL CLIENTE. BLACKMAGIC DESIGN NON SI ASSUME ALCUNA RESPONSABILITÀ PER DANNI DERIVANTI DALL'USO DI QUESTO PRODOTTO. IL CLIENTE UTILIZZA QUESTO PRODOTTO A PROPRIO RISCHIO.

© Copyright 2020 Blackmagic Design. Tutti i diritti riservati. 'Blackmagic Design', 'DeckLink', 'HDLink', 'Workgroup Videohub', 'Multibridge Pro', 'Multibridge Extreme', 'Intensity' and 'Leading the creative video revolution' sono marchi registrati negli Stati Uniti e in altri Paesi. Altri nomi di prodotti e aziende qui contenuti possono essere marchi dei rispettivi proprietari.



Manual de Instalação e Operação

SmartView & SmartScope

Setembro 2020

Português



Bem-vindo!

Esperamos que você compartilhe do nosso sonho de transformar a indústria televisiva em uma indústria verdadeiramente criativa, permitindo que todos tenham acesso a vídeos da mais alta qualidade.

O monitoramento de vídeo é necessário em todas as partes de uma instalação e os monitores SmartView são opções ideais. O SmartView 4K possui uma tela LCD com 4K nativo para o monitoramento de vídeos Ultra HD em resolução máxima, além de um gabinete elegante de 6U com um painel de controle que permite alterar as configurações rapidamente. O SmartView HD inclui uma tela LCD de 17" em um gabinete para rack de 6U com menos de uma polegada de espessura. Já o SmartView Duo inclui duas sofisticadas telas LCD de 8" completamente independentes em um gabinete para rack de 3U com menos de uma polegada de espessura. O SmartScope Duo 4K conta com duas telas LCD de 8" independentes com funcionalidade para escopo de forma de onda, permitindo que você monitore seus níveis de vídeo com agilidade. Todos os monitores SmartView são compatíveis com vídeos SD, HD e 2K via 3G-SDI. O SmartScope Duo 4K e o SmartView 4K também são compatíveis com Ultra HD 4K via 6G-SDI e 12G-SDI respectivamente!

O monitoramento de vídeo foi desenvolvido para uso imediato e nosso software Blackmagic SmartView fornece ao usuário uma ferramenta de configuração fácil e intuitiva.

Este manual de instrução contém todas as informações necessárias para instalar seu SmartView e SmartScope, embora seja aconselhável pedir ajuda a um assistente técnico se não tiver certeza sobre os endereços IP ou se não entender bem sobre redes de computador. O SmartView e SmartScope são fáceis de instalar, mas há algumas preferências um pouco mais técnicas que você pode precisar configurar após a instalação. Ela deve levar cerca de 5 minutos para ser concluída.

Por favor, visite nosso site www.blackmagicdesign.com/br e clique na página de suporte para baixar as últimas atualizações deste manual e do software SmartView. Por fim, registre seu dispositivo ao baixar as atualizações de software para que possamos mantê-lo informado quando lançarmos novos programas. Estamos sempre trabalhando com novos recursos e aprimoramentos, então gostaríamos muito de ouvir a sua opinião!

Grant Petty

Diretor Executivo da Blackmagic Design

Índice

SmartView & SmartScope

Instruções Preliminares	365
SmartView e SmartScope	365
Conectar Fontes de Vídeo	366
Conectar Computador	366
Instalar Blackmagic SmartView Setup	367
Usar Blackmagic SmartView Setup	368
Atualizar o Software	368
Ajustar Configurações do Monitor	368
Habilitar Bordas de Sinalização	371
Usar SmartView 4K	371
Blackmagic SmartView 4K	371
Botões do Painel de Controle	372
Carregar LUTs 3D Usando Blackmagic SmartView Setup	374
Usar SmartScope Duo 4K	375
O que é Blackmagic SmartScope?	375
Display para Monitoramento de Vídeo	376
Display em Forma de Onda	377
Display em Vetorscópio	378
Display em Padrões	379
Display em Histograma	381
Display com Medição de Áudio	382
Conectar a uma Rede	383
Ethernet Direta	383
Switch de Rede Ethernet	384
Ajustar Configurações de Rede	385
Configurações de Rede	385
Adicionar um Monitor Blackmagic	387
Usar Sinalização	388
Conexões dos Pinos da Porta de Sinalização	388
Otimizar o Ângulo de Visualização	389
Informações para Desenvolvedores	391
Blackmagic 2K Format – Visão Geral	391
Blackmagic 2K Format – Referência de Cronometragem Vertical	392
Blackmagic 2K Format – Formato de Fluxo de Dados	393
Blackmagic SmartView Ethernet Protocol v1.3	394
Ajuda	398
Informações Regulatórias	399
Informações de Segurança	400
Garantia	401

Instruções Preliminares

SmartView e SmartScope

Os monitores SmartView são ideais para qualquer instalação que necessite de monitoramento baseado em rack. Para instalar e começar a usá-los, basta conectá-los à energia e a uma fonte SDI!

O SmartView 4K possui um LCD 4K de 15.6" para o monitoramento de vídeos SD, HD ou Ultra HD na sua resolução nativa de 3840x2160 pixels. Os botões no painel de controle frontal permitem selecionar entradas com facilidade, bem como ajustar o brilho da tela, verificar ruídos no canal azul, visualizar informações de apagamento, aplicar LUTs 3D e muito mais.

O SmartView HD possui um LCD HD de 17", perfeito para um monitoramento em resolução Full HD confiável.

O SmartView Duo inclui dois monitores para a exibição simultânea de sinais de vídeo diferentes. Assim, um monitor pode exibir um sinal YUV 4:2:2 enquanto o outro recebe um sinal RGB 4:4:4, por exemplo. Ou, um monitor pode exibir NTSC enquanto o outro exibe PAL. Há muitas combinações possíveis, mas todas são tão simples quanto conectar um único cabo SDI a cada monitor!

O SmartScope Duo 4K tem os mesmos recursos que o SmartView Duo, e ainda poder ser usado para exibir forma de onda, vetorscópico e outros escopos populares para o monitoramento de níveis de áudio e vídeo em tempo real. E mais, você obtém suporte completo para Ultra HD 4K!

Todas as conexões de entrada SDI nos monitores SmartView e SmartScope são compatíveis com detecção automática de vídeos SD, HD ou 3G-SDI, assim como 2K. O SmartView 4K também detecta Ultra HD, incluindo formatos como 2160p60 via 12G-SDI. O SmartScope Duo 4K inclui detecção automática de vídeos Ultra HD 4K via 6G-SDI.

Caso queira ajustar remotamente as configurações de múltiplos dispositivos SmartView e SmartScope a partir de um único computador, basta conectá-los juntos via Ethernet. Ou seja, você não precisará correr para cada unidade com um computador e cabo USB toda vez que quiser fazer ajustes.

Essas são as informações básicas para você poder começar! Por favor, continue lendo para mais detalhes sobre como conectar o SmartView e SmartScope, configurar os parâmetros do monitor no Blackmagic SmartView Setup e conectar a uma rede.



SmartView 4K



SmartView HD



SmartView Duo



SmartScope Duo 4K

Conectar Fontes de Vídeo

Os monitores SmartView e SmartScope contam com conectores BNC comuns para conexão com equipamentos SDI, incluindo switchers, câmeras, placas de captura, decks e gravadores de disco.

Como Obter uma Imagem

É muito fácil exibir o seu vídeo! Basta ligar o dispositivo e conectar sua fonte de vídeo a uma entrada SDI. Logo em seguida, seu vídeo deve estar visível. Os sinais SD, HD e 2K são automaticamente detectados pelas conexões da entrada SDI e saída loop through. O SmartView 4K e SmartScope Duo 4K também detectam Ultra HD 4K.

Quando nenhum vídeo é recebido pela unidade, a luz de fundo é desligada para economizar energia até que o próximo sinal válido seja recebido.

Monitores Montados em Cascata

Cada monitor SmartView e SmartScope tem sua própria entrada SDI independente, bem como uma saída loop through, assim você pode montar múltiplos monitores em cascata para exibir o mesmo sinal de entrada:

- 1 Ligue a unidade 1. Conecte uma fonte de vídeo a uma entrada SDI. O vídeo deve aparecer imediatamente.
- 2 Ligue a unidade 2. Conecte um cabo SDI de uma saída loop da unidade 1 a uma entrada SDI da unidade 2.

Não há um limite quanto ao número de unidades que você pode montar em cascata.

Caso esteja monitorando em onda de forma usando o SmartScope Duo 4K, é provável que queira fazer o loop da saída do "Monitor 1" para o "Monitor 2" para que ambos os displays passem a usar o mesmo sinal de entrada.

Agora que o vídeo está sendo exibido, é possível ajustar as configurações do monitor ou selecionar os escopos no SmartScope Duo 4K usando o software Blackmagic SmartView Setup, o qual também pode ser utilizado para carregar LUTs 3D no Blackmagic SmartView 4K.



SmartView 4K



SmartView HD



SmartView Duo



SmartScope Duo 4K

Conectar Computador

Configure os parâmetros do monitor SmartView ou SmartScope conectando-o ao seu computador via USB e instalando o Blackmagic SmartView Setup.

A conexão USB também pode ser usada para atualizações internas do software baixado através do site da Blackmagic Design. As atualizações do software podem fornecer novos recursos, compatibilidade com novo hardware e suporte para novos formatos. O software Blackmagic SmartView Setup opera tanto nos computadores macOS quanto Windows.

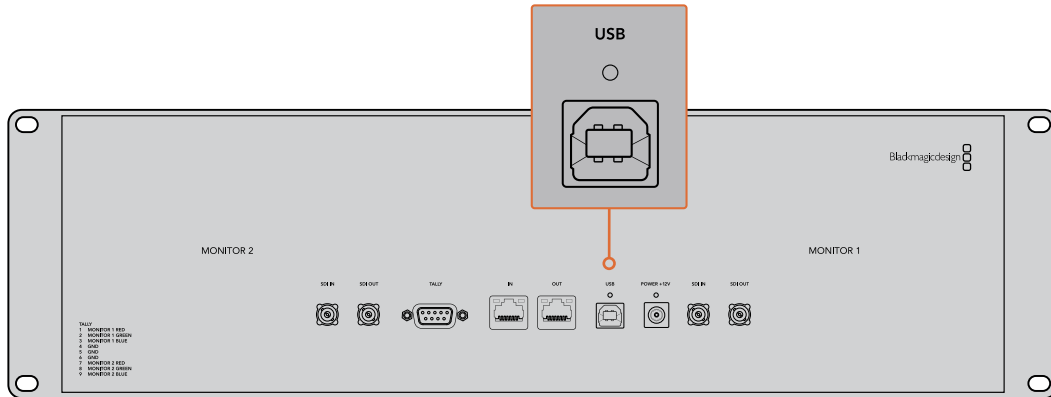

Instalar Blackmagic SmartView Setup

O Blackmagic SmartView Setup é executável nas versões Sierra e High Sierra mais recentes do macOS e nas versões de 64 bits do Windows 8.1 e 10 com os últimos pacotes de serviço (service packs) instalados. O Blackmagic SmartView Setup pode ser instalado em múltiplos computadores em rede, se necessário.

O cartão SD fornecido com o SmartView contém o instalador de software, mas recomendamos que você visite a página www.blackmagicdesign.com/br/support para certificar-se de que tenha a última versão.

Como instalar no macOS:

Abra o cartão SD fornecido, ou baixe a imagem de disco, e dê um clique duplo no ícone de instalação do SmartView. Uma pasta do SmartView será criada na sua pasta de aplicativos com o SmartView Setup, assim como um desinstalador para a remoção de versões antigas ao fazer a atualização e uma pasta de documentos com este manual e outras informações sobre o SmartView.

Como instalar no Windows:

Abra o cartão SD fornecido, ou o arquivo zip baixado, e dê um clique duplo no instalador do SmartView. Siga as solicitações na tela para instalar o software.

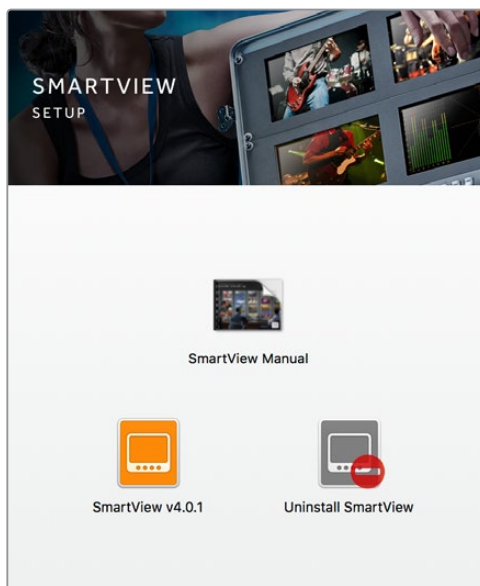

Para instalação no macOS, inicie o arquivo SmartView.dmg no cartão SD fornecido, ou a partir da sua pasta de downloads, e dê um clique duplo no ícone de instalação do SmartView.

Usar Blackmagic SmartView Setup

Atualizar o Software

Depois de instalar e iniciar o Blackmagic SmartView Setup, clique no ícone de configuração abaixo do nome do seu monitor. Pode ser que você seja solicitado a atualizar o software interno do seu SmartView ou SmartScope. Para fazer isto:

- 1 Conecte seu SmartView ou SmartScope ao computador via USB ou Ethernet e inicie o Blackmagic SmartView Setup.
- 2 Quando solicitado, basta clicar em "Update". A atualização deve levar 5 minutos para ser finalizada.
- 3 A mensagem "This SmartView has been updated" deve aparecer após conclusão da atualização.
- 4 Clique em "Close" para fechar.

Se nenhuma atualização de software for necessária, o Blackmagic SmartView Setup abrirá a página de configurações para seu monitor.

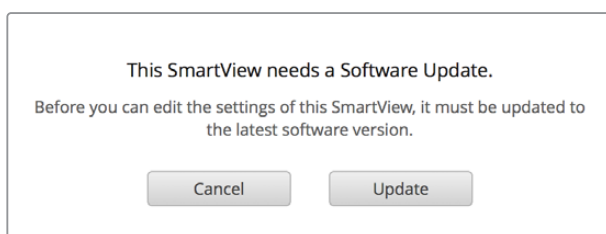

Ao iniciar o SmartView Setup e abrir o ícone de configuração do seu SmartView ou SmartScope conectado, esta mensagem aparecerá caso uma atualização do software interno seja necessária.

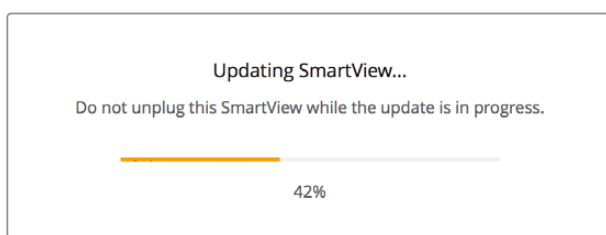

A atualização deve levar 5 minutos para ser finalizada.

Ajustar Configurações do Monitor

Imediatamente após ser iniciado, o Blackmagic SmartView Setup procurará por quaisquer unidades SmartView ou SmartScope conectadas via USB ou Ethernet e as exibirá na sua página inicial. Caso tenha mais de um monitor Blackmagic conectado à sua rede, clique nos ícones das setas esquerda e direita em cada lado da página inicial para selecionar o monitor que deseja ajustar. Se o seu monitor Blackmagic estiver conectado via USB, um ícone de USB aparecerá próximo do nome do monitor.

Para ajustar as configurações, selecione seu monitor conectado via Ethernet e USB e clique no ícone de configuração abaixo do nome do monitor. A página de configurações do seu monitor selecionado abrirá. Quando estiver satisfeito com suas configurações, clique no botão “Save” para salvá-las e retorne para a página inicial do SmartView Setup.

Leia a próxima seção para informações sobre as configurações disponíveis para os monitores Blackmagic e como usá-las. Para detalhes sobre como configurar os parâmetros de rede usando o Blackmagic SmartView Setup, consulte a seção ‘Ajustar Configurações de Rede’.

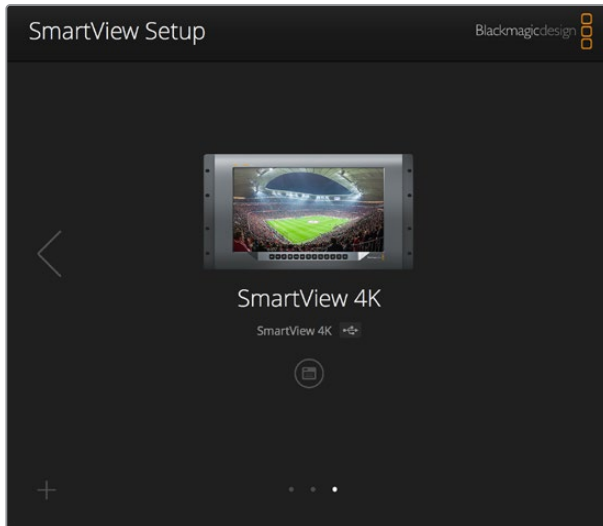

O Blackmagic SmartView Setup procura automaticamente por quaisquer unidades SmartView e SmartScope conectadas localmente via USB ou através de uma rede. Ao atualizar o software interno do seu monitor, certifique-se de que o monitor esteja conectado via USB ou Ethernet. Um ícone de USB aparecerá próximo ao nome do seu monitor.

Configurações do Monitor

Para ajustar as configurações e os displays de cada monitor, eles devem estar conectados via Ethernet ou USB. Selecione o monitor que deseja configurar clicando nos ícones das setas esquerda e direita na página inicial do SmartView Setup e, depois, clique no ícone de configuração abaixo do nome do seu monitor. A página de configurações é personalizada automaticamente para adequar-se aos recursos compatíveis com seu monitor Blackmagic selecionado.

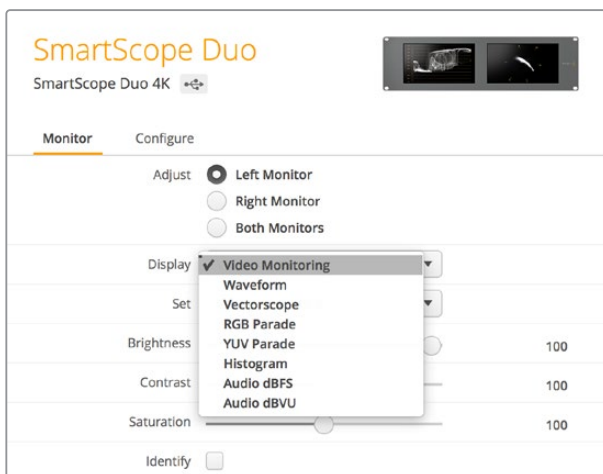

Com o SmartScope, você pode selecionar entre monitoramento de vídeo ou escopos a partir do menu suspenso “Display”.

Adjust

Ao usar um SmartScope ou SmartView Duo, escolha o monitor que deseja ajustar selecionando “Left Monitor” (monitor esquerdo), “Right Monitor” (monitor direito) ou “Both Monitors” (ambos os monitores) para ajustar os dois ao mesmo tempo. Quando a configuração “Both Monitors” é habilitada, todos os ajustes de brilho, contraste e saturação são empregados a ambos os monitores no SmartView Duo e SmartScope.

Display

Ao usar um SmartScope, o menu suspenso “Display” fornece escopos selecionáveis. Selecione “Video Monitoring” caso queira ver apenas a imagem de vídeo.

Set

Ao usar um SmartScope, o menu suspenso “Set” permite que você selecione proporções de tela 4:3 ou 16:9 para o display de monitoramento de vídeo quando estiver usando vídeo de definição padrão. O menu suspenso “Set” fornece opções adicionais para o display selecionado, incluindo vetorscópico, áudio dBFS e áudio dBVU.

- **Video Monitoring:** Selecione esta opção para visualizar a imagem de vídeo usando as proporções de tela 4:3 ou 16:9.
Ao visualizar vídeos em definição padrão no formato widescreen anamórfico, opte pela proporção de tela 16:9. Ao visualizar vídeos em definição padrão no formato tradicional 4:3, opte pela proporção de tela 4:3.
- **Vectorscope:** Selecione esta opção se sua entrada estiver baseada em sinais de teste de barras de cor a 100% ou 75%.
- **Audio dBFS:** Selecione o par de canais de áudio para monitorar a fase.
- **Audio dBVU:** Selecione o par de canais de áudio para monitorar a fase.

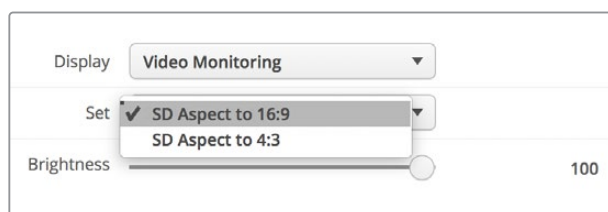

Configure “SD Aspect to 16:9” quando estiver visualizando vídeos em definição padrão no formato anamórfico.

Brightness, Contrast, Saturation

Ajuste os deslizadores para aplicar as configurações de brilho, contraste e saturação. As configurações disponíveis serão diferentes nos modelos SmartView e SmartScope.

Identify

Quando a caixa de verificação “Identify” estiver habilitada, todos os monitores selecionados na configuração do Blackmagic SmartView exibirão uma borda branca. Se algumas unidades SmartView e SmartScope estiverem conectadas via uma rede, esta configuração facilitará a identificação visual do monitor selecionado.

Se esta configuração for usada junto com a configuração “Both Monitors”, a borda branca será exibida em ambos os monitores SmartScope Duo e SmartScope Duo 4K.

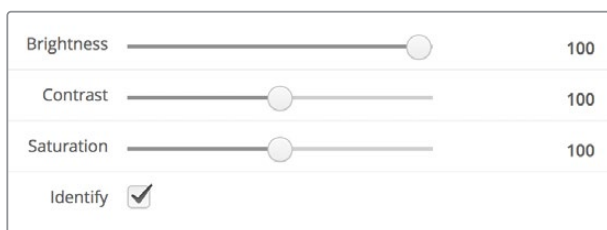

Arraste os deslizadores para a esquerda e direita para ajustar as configurações de brilho, contraste e saturação. Marque a configuração “Identify” para identificar visualmente o seu monitor selecionado.

Habilitar Bordas de Sinalização

Selecione “Enable tally override” para habilitar as bordas de sinalização no Blackmagic SmartView 4K. Este recurso é compatível com os modelos Blackmagic URSA Mini Pro 4.6K e Blackmagic URSA Broadcast.

Conecte a saída SDI da câmera à entrada A ou B do seu SmartView 4K.

Conecte a saída de programa do switcher ATEM à entrada SDI da câmera.

Quando o switcher ATEM alternar a câmera para a saída de programa, uma borda de sinalização vermelha será aparecerá no seu SmartView 4K. Quando alternada para a saída de pré-visualização, será exibida uma borda de sinalização verde.

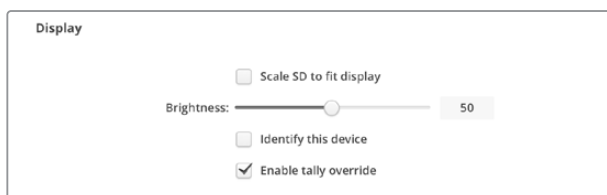

Clique na opção “Enable tally override” para exibir bordas de sinalização no SmartView 4K quando conectado a uma câmera Blackmagic URSA Mini Pro ou URSA Broadcast.

Usar SmartView 4K

Blackmagic SmartView 4K

O SmartView 4K é um monitor broadcast Ultra HD 12G-SDI baseado em rack de 6U para exibição de conteúdo SD, HD e visualização nativa de vídeos Ultra HD de até 2160p60. Com um display luminoso e um ângulo de visualização amplo, o SmartView 4K fornece uma imagem absolutamente clara e expressiva para o monitoramento de cor e foco preciso e é compatível com praticamente todos os formatos de vídeo.

Desenvolvido para estúdios e ambientes broadcast externos, o SmartView 4K é incrivelmente fácil de usar. Ele inclui conectores para encaixe lateral e suporte VESA, podendo ser usado em espaços apertados, fixado na parede ou em braços articulados. O SmartView 4K pode ser operado usando o painel de controle integrado ou remotamente via Ethernet, se você não tiver acesso ao painel frontal.

As duas entradas 12G-SDI multitaxa permitem que você selecione entre duas fontes SDI e há um soquete de módulo SFP compatível com SMPTE para adicionar um módulo SDI de fibra óptica e conectar seu vídeo via fibra óptica! A saída 12G-SDI é fornecida para que você possa alimentar seu vídeo a outros equipamentos, além de dois conectores de Ethernet para rede, controle remoto e

saída loop para monitoramento em cascata. Outros conectores incluem uma entrada de sinalização para produção ao vivo, e uma porta USB para atualizações de software interno.

Você pode até carregar LUTs 3D padrão da indústria com extensão .cube ou LUTs geradas pelo DaVinci Resolve usando o software de configuração Blackmagic SmartView! Com as LUTs 3D, você pode conectar seu SmartView 4K diretamente à sua câmera e visualizar seus cliques da maneira mais próxima possível da gradação final. Os dois níveis de saliência garantem que suas filmagens mantenham o foco perfeito e, com o suporte para alimentação AC e DC, você tem a opção de conectar o SmartView 4K a tomadas ou usar uma bateria externa para portabilidade no set.

O SmartView 4K é a solução de monitoramento perfeita para produções portáteis broadcast e de estúdio exibindo vídeos em SD, HD e Ultra HD na sua resolução nativa de 3840x2160 pixels.

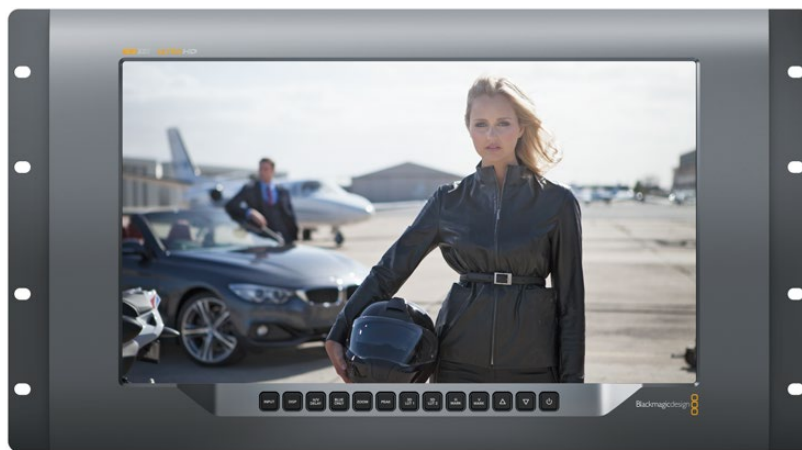

OBSERVAÇÃO Caso esteja conectando alimentação externa através da entrada de alimentação DC, certifique-se de que sua saída de alimentação externa seja capaz de fornecer 24 watts a 12 volts.

Botões do Painel de Controle

O painel de controle inclui uma fileira de botões para que você possa ajustar rapidamente as configurações do seu SmartView 4K.

Input

Ao pressionar este botão, é possível percorrer pelos sinais de vídeo conectados às duas entradas 12G-SDI do SmartView e à entrada do módulo SFP de fibra óptica opcional. Se nenhum vídeo estiver conectado a uma das entradas, o SmartView 4K exibirá uma imagem preta para essa entrada. Ao alternar entre as entradas, informações sobre o formato da entrada conectada serão exibidas momentaneamente no canto superior esquerdo do seu monitor.

Disp

O botão “Disp” é usado para ajustar a configuração de brilho na tela LCD do seu SmartView 4K. Ajuste o brilho pressionando os botões de seta para cima e para baixo. Pressione o botão “Disp” mais uma vez para fechar a configuração.

H/V Delay

O botão “H/V Delay” permite que você confirme com rapidez a presença de dados ANC embutidos no sinal de vídeo SDI. Pressione esse botão uma vez para visualizar os dados ANC horizontais e o pressione novamente para visualizar os dados ANC verticais, comumente usados para dados como legendagem oculta.

Blue Only

Caso haja ruídos em um sinal de vídeo digital, ele proeminentemente estará dentro do canal azul. Você pode verificá-los facilmente no seu canal azul pressionando o botão “Blue Only”. Ele exibe somente o canal azul representado como uma imagem preta e branca. Essa imagem preta e branca também pode ser usada para assistência ao verificar o foco da câmera.

Zoom

Um jeito de alcançar um foco de câmera nítido é usando o botão “Zoom”. Pressione uma vez para aplicar o zoom à imagem e você poderá ver claramente se o objeto está em foco. Pressione “Zoom” novamente para retornar ao tamanho de visualização normal.

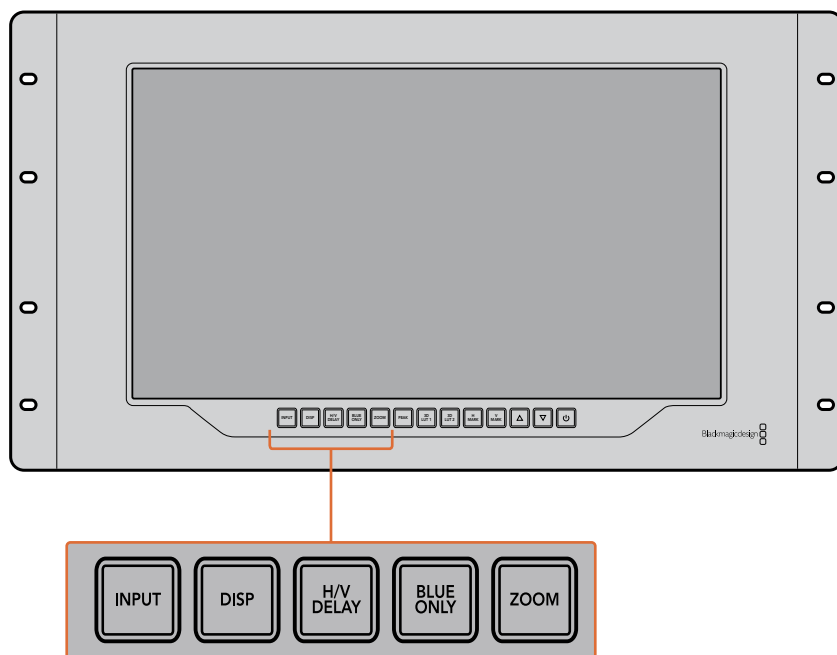

Peak

O foco de câmera pode ser facilmente verificado pressionando o botão “Peak” para habilitar a saliência. Ele exibe uma borda verde luminosa ao redor dos pontos mais proeminentes na sua imagem. Há dois níveis de intensidade de saliência, pelos quais você pode percorrer pressionando subsequentemente o botão “Peak”. Quando as bordas verdes exibem sua intensidade máxima, você pode ter certeza de que sua câmera está em foco.

3D LUT 1 e 3D LUT 2

Os botões “LUT” permitem que você veja sua imagem usando as LUTs 3D personalizadas geradas no Blackmagic DaVinci Resolve ou as LUTs no formato padrão de indústria .cube. Pressione o botão “LUT” uma vez para habilitar a LUT. Pressione novamente para desabilitá-la. Consulte a seção ‘Carregar LUTs 3D Usando Blackmagic SmartView’ para mais informações sobre como usar LUTs 3D com o SmartView 4K.

H Mark e V Mark

É possível visualizar e editar marcadores de quadro usando os botões “H Mark” e “V Mark”. Os marcadores de quadro ajudam a compor filmagens ou manter informações ou gráficos importantes na área segura da tela. Televisores diferentes exibem um pouco mais ou menos das extremidades de um sinal de vídeo, então vale a pena visualizar uma área segura. Ela é a seção da tela que sempre estará visível, independentemente do televisor ou do monitor usado para visualização.

Para ver marcadores horizontais e verticais, pressione os botões “H Mark” e “V Mark”, respectivamente. Para editar os marcadores, pressione os respectivos botões novamente para realçar cada guia. Isto permite que você edite as posições dos marcadores usando os botões de seta para cima e para baixo. Ao pressionar subsequentemente cada botão, você confirmará suas novas posições. Se pressionar mais uma vez, você desabilitará os marcadores.

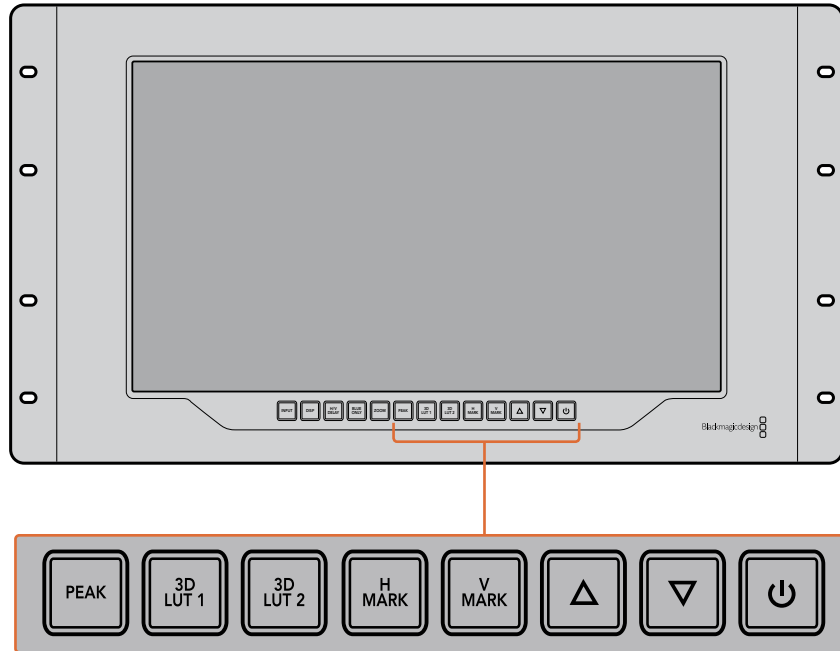

Botões de Seta Para Cima e Para Baixo

Use os botões de seta para cima e para baixo quando estiver editando uma configuração, como ajustando o brilho do display ou editando as posições do marcador de quadro.

Alimentação

Pressione o botão de alimentação uma vez para ligar o seu SmartView 4K. Pressione mais uma vez para desligá-lo.

Carregar LUTs 3D Usando Blackmagic SmartView Setup

O SmartView 4K permite que você monitore seu vídeo usando LUTs 3D. Isto lhe proporciona a opção de calibrar o seu SmartView 4K usando LUTs com calibração profissional ou de visualizar seu vídeo da maneira mais próxima possível da sua gradação final. Você também pode usar as LUTs 3D para experimentar looks diferentes. As LUTs são carregadas no SmartView 4K usando o Blackmagic SmartView Setup e, como o SmartView 4K é compatível com LUTs com a extensão de arquivo .cube, você pode até carregar LUTs personalizadas geradas com o DaVinci Resolve. Consulte o manual do DaVinci Resolve para mais informações sobre como gerar arquivos LUT.

Como carregar uma LUT 3D na LUT 3D 1:

- 1 Inicie o Blackmagic SmartView Setup.
- 2 Pressione o botão de carregamento “Load LUT 1”. Uma janela abrirá perguntando sobre a localização que você deseja carregar o arquivo LUT. Selecione o arquivo LUT .cube desejado e pressione o botão “Open”.
- 3 Para visualizar a LUT carregada, pressione o botão “3D LUT 1” no painel de controle SmartView 4K. Pressione o botão novamente para desativar a LUT.

Siga o mesmo procedimento para carregar um arquivo LUT na LUT 3D 2.

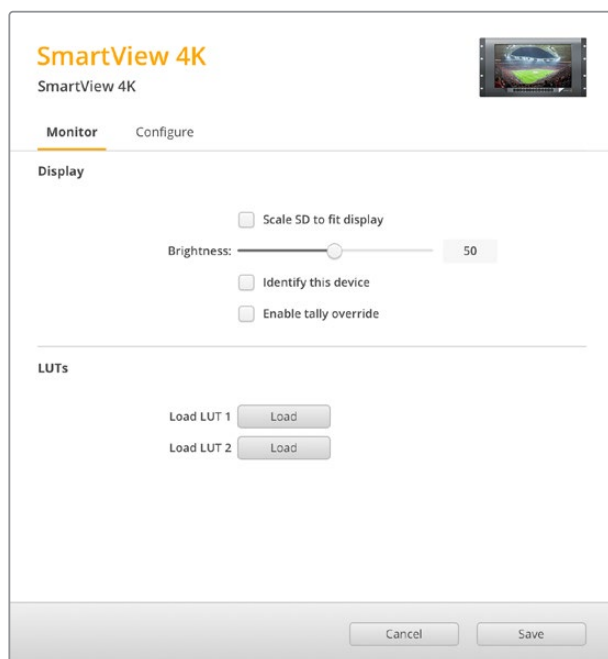

Use o Blackmagic SmartView Setup para carregar LUTs 3D no seu SmartView 4K.

Usar SmartScope Duo 4K

O que é Blackmagic SmartScope?

Antigamente, os escopos de pós-produção e televisão de qualidade broadcast eram soluções extremamente caras que permitiam apenas a visualização de um escopo de cada vez em uma tela superpequena! Além disso, alguns escopos são feios e não passam uma boa impressão para o cliente.

Com o SmartScope Duo 4K, você obtém monitores de forma de onda que permitem que você acompanhe qualquer aspecto do seu sinal de vídeo em monitores duplos em tempo real. Todos os ajustes feitos no sinal de entrada no Blackmagic SmartView Setup podem ser vistos imediatamente no SmartScope Duo 4K! E mais, cada sinal de entrada pode ser enviado para qualquer um dos monitores via a saída SDI loop, ou seja, você pode usar o monitor da direita para exibir o escopo do sinal indo para o monitor da esquerda.

Os escopos exibidos pelo SmartScope Duo 4K são selecionados no software Blackmagic SmartView Setup. Selecione seus escopos a partir do menu suspenso “Display”.

A informação abaixo e nas próximas páginas explica como cada exibição de escopo é aplicada para que você obtenha um entendimento melhor sobre cada uma das suas funções.

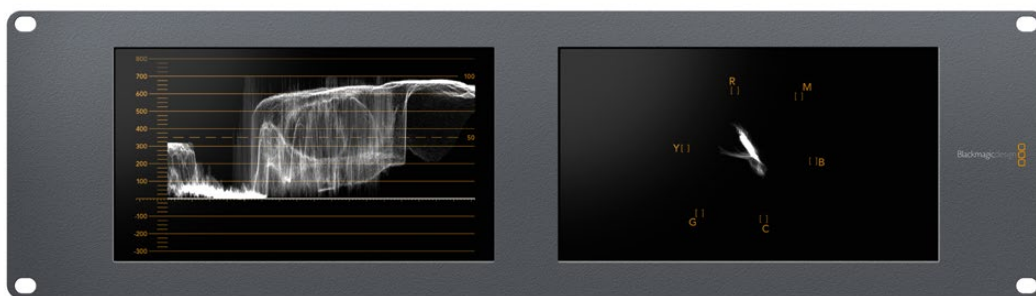

É fácil configurar seu Blackmagic SmartScope Duo 4K para exibir um escopo diferente em cada monitor usando o Blackmagic SmartView Setup.

Display para Monitoramento de Vídeo

O display “Video Monitoring” oferece um monitoramento confiável e útil para que você possa visualizar o vídeo que está sendo recebido pelo SmartScope.

Se seu sinal de entrada for SD, você pode optar por exibi-lo em tarjas laterais 4:3 ou 16:9 através do menu suspenso “Set”. Quaisquer alterações feitas nas configurações de brilho, contraste ou saturação da tela LCD podem ser imediatamente visualizadas neste modo. Observe que a alteração dessas configurações afeta apenas o monitor e não o sinal de vídeo, assim os escopos não serão impactados por essas mudanças de saturação ou brilho.

É útil configurar um monitor como “Video Monitoring” e o outro para a visualização de seu escopo. Para fazer isto, use um cabo curto para conectar a saída loop SDI do “Monitor 1” à entrada SDI do “Monitor 2”.

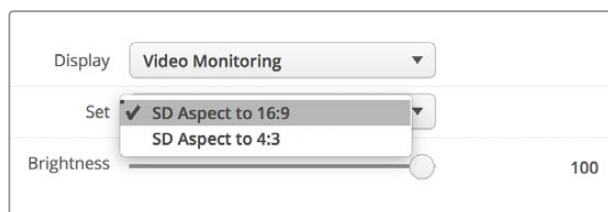

Você pode visualizar vídeos SD em tarjas laterais 4:3 ou em widescreen 16:9 selecionando as opções do menu “Set” no Blackmagic SmartView Setup. Configure “SD Aspect to 16:9” quando estiver visualizando vídeos em definição padrão no formato anamórfico.

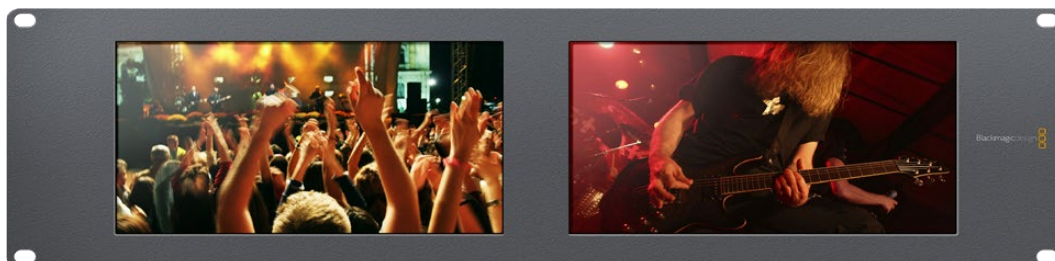

A configuração do display para monitoramento de vídeo exibe o sinal de vídeo da forma como ele geramente aparece na tela do televisor ou monitor.

Display em Forma de Onda

O display “Waveform” fornece uma forma de onda codificada digitalmente de modo semelhante aos monitores de forma de onda de luminância tradicional, usado para monitorar e ajustar os níveis de luminância (brilho) do seu sinal de vídeo.

Os monitores de forma de onda de luminância tradicional são compatíveis apenas com vídeos de definição padrão no formato composto analógico. No entanto, a visualização em forma de onda do SmartScope Duo 4K funciona em Ultra HD e HD assim como SD, assim você pode ajustar os níveis de luminância de forma consistente e fácil mesmo ao monitorar formatos de vídeo digital em alta definição!

Selecione a forma de onda a partir do menu suspenso “Display” no Blackmagic SmartView Setup. Você deve certificar-se de que os pretos na sua forma de onda não atinjam 0% e os brancos não ultrapassem 100%, pois isso significa que você está obtendo valores de luminância ilegais.

O monitoramento em forma de onda é uma representação gráfica da imagem, que mostra valores de luminância na mesma posição em relação àqueles dentro do quadro. Por exemplo, se parte do céu estiver superexposta, você a verá na mesma posição horizontal no display em forma de onda que ela aparece no quadro.

Dependendo da sua imagem, sua forma de onda terá uma aparência diferente. Se estiver monitorando vídeos de alto contraste, pode ser que não veja valor algum nos tons de cinza. A imagem abaixo apresenta uma forma de onda de uma imagem exposta uniformemente com um patch escuro à esquerda e valores mais luminosos do centro do quadro para a direita.

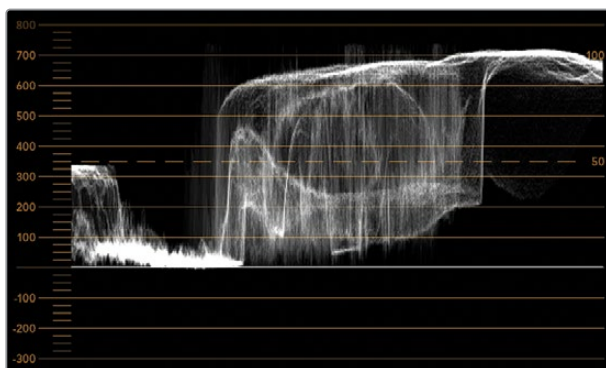

Display em forma de onda exibindo valores de luminância.

Adjust	<input checked="" type="radio"/> Left Monitor
	<input type="radio"/> Right Monitor
	<input type="radio"/> Both Monitors
Display	Waveform ▼
Set	No Options ▼

Selecione “Waveform” nas configurações “Display” do Blackmagic SmartView Setup para visualizar os valores de luminância no seu sinal de vídeo.

Display em Vetorscópio

O display “Vectorscope” exibe as cores em um sinal de vídeo. Dependendo do padrão dos sinais de teste de barras de cor usado na sua instalação, selecione 100% ou 75% no menu suspenso “Set” no Blackmagic SmartView Setup.

Algumas pessoas acreditam que o vetorscópio pode ser usado para verificar níveis ilegais, mas isso não é correto. O display no padrão RGB é que deve ser usado para a verificação de cores ilegais. O motivo pelo qual você não pode usar um vetorscópio para tal verificação é que ambos os valores de cromaticidade e luminância são necessários. Por exemplo, as cores próximas dos pontos brancos ou pretos no vídeo não podem ser saturadas como as cores muito mais escuras, que podem ser usadas nos tons de cinza. Como o display em vetorscópio exibe somente cores, e não valores de luminância, ele não pode ser usado exclusivamente para verificar cores ilegais.

O display em vetorscópio é a melhor ferramenta para verificar níveis de cores de fitas de vídeo analógicas antigas, onde você precisa ajustar níveis cromáticos. Basta reproduzir o segmento da barra de cores da fita de vídeo e, depois, ajustar as configurações cromáticas e de matiz para definir as cores do vídeo nas caixas quadradas na graticula.

O display em vetorscópio também é perfeito para gradação de cor, já que você pode facilmente ver se seu vídeo recebeu balanço de branco corretamente ou se há um tom de cor. Se seu vídeo possuir um tom de cor, o display desviará para o centro e você provavelmente verá dois pontos centrais. Geralmente, o apagamento no sinal de vídeo cria um ponto no centro do vetorscópio e isso acontece porque o apagamento no vídeo é preto sem qualquer cor. O apagamento fornece um ponto de referência útil para ajudar a reconhecer áreas do vídeo preto sem qualquer informação de cor.

Se seu vídeo tiver um tom de cor, você poderá visualizar os pretos se afastando da cor e do centro. O grau de deslocamento representa a quantidade do tom de cor no seu vídeo e é possível ver o afastamento nos detalhes pretos e brancos do seu vídeo. Isto faz com que o display em vetorscópio seja valioso na remoção do tom de cor e na recuperação do balanço de branco correto.

Este tipo de display permite que você trabalhe com cores no seu vídeo dentro dos limites, sem adicionar acidentalmente tons indesejados aos pretos e brancos. O balanço de cor branca pode ser monitorado tanto no display em padrões RGB quanto no display em vetorscópio. Os problemas com balanço de cor serão geralmente mais fáceis de visualizar no display em vetorscópio.

Ao fazer a correção de cor de imagens com tons de pele, especialmente rostos, você deve manter a saturação da cor quente ao longo de uma linha aproximadamente na posição de 10 horas no vetorscópio. Isto é conhecido como “flesh tone line” e é baseado na cor do sangue sob a superfície da pele. A “flesh tone line” é, portanto, aplicável a todos as pigmentações de pele e é a melhor maneira de garantir que os tons de pele do seu talento fiquem naturais.

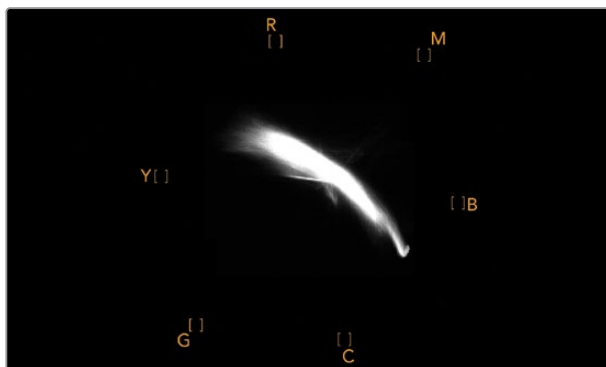

Display em vetorscópio exibindo “flesh tone line” em direção à posição de 10 horas.

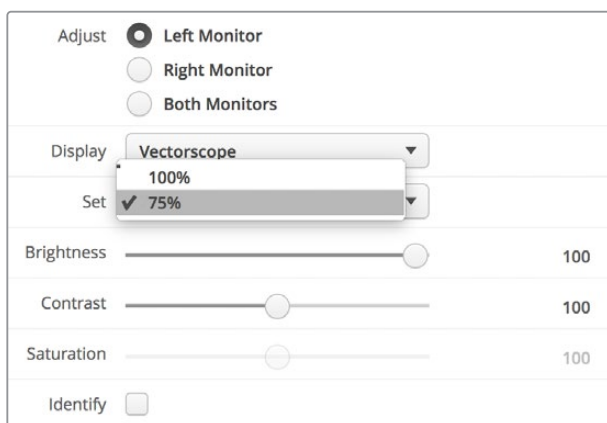

Configure seu vetorscópico como sinais de teste de barras de cor a 100% ou 75%.

Display em Padrões

Os displays “RGB Parade” e “YUV Parade” são ideais para correção de cor, verificação de cores ilegais e verificação de níveis.

Ao fazer a correção de cor, selecione “RGB Parade” no menu suspenso “Display” no Blackmagic SmartView Setup. A visualização no padrão RGB exibe a altura máxima dos canais individuais de cor vermelho, verde e azul. O monitoramento dos níveis de cada canal simplifica a correção de cor e também é fácil visualizar o balanço de cor nos pretos, meios-tons e brancos do sinal de vídeo. O display no padrão RGB possibilita que você identifique os detalhes comuns aos canais vermelho, verde e azul, simplificando o balanço de cor e a remoção de tons de cor indesejados.

Ao fazer a correção de cores, é importante certificar-se de que os níveis de vídeo estejam completos, mas não cortados. Caso queira aumentar o nível de vídeo, certifique-se também de que ele não ultrapasse o limite RGB ou você obterá níveis ilegais. Alguns equipamentos não permitem a geração de níveis 100% RGB ilegais, porém outros equipamentos permitirão. O SmartScope Duo 4K deixa você visualizar os níveis ilegais sempre que eles ocorrerem.

Vídeos ilegais também podem ocorrer nos níveis de preto e branco. Em alguns sistemas de correção de cor, os níveis de preto podem ser reduzidos para o ponto preto abaixo de 0%. Se você notar níveis de preto ilegais, basta adicionar um pedestal, “Lift”, ou ganho para eliminá-los, mas verifique o nível de graticula a 100% para garantir que todo o sinal de vídeo não tenha sido elevado e gerado cores ilegais nos brancos.

Para checar os níveis YUV, selecione “YUV Parade” no menu suspenso “Display”. Esta visualização é útil porque os valores de luminância (brilho) são separados dos valores cromáticos (cor), o formato dos sinais de vídeo para a teledifusão. A forma de onda da esquerda mostra as informações de luminância e a segunda e terceira formas de onda exibem as informações cromáticas. A visualização no padrão YUV é útil para a calibração dos valores cromáticos dos sinais de vídeo para um padrão de teste de barra de cores, assim as cores são representadas fielmente e o sinal sendo transmitido é exibido pelos televisores.

A correção de cor é um processo de ajuste constante que ajuda a alcançar as melhores imagens sem gerar níveis ilegais!

Terminologia de Correção de Cores

Pretos – Níveis de pretos no sinal de vídeo

Meios-Tons – Níveis de tons de cinza no sinal de vídeo

Brancos – Níveis de brancos no sinal de vídeo

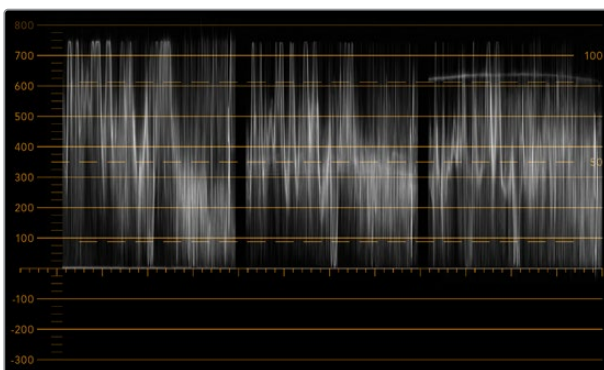

Visualização no padrão RGB.

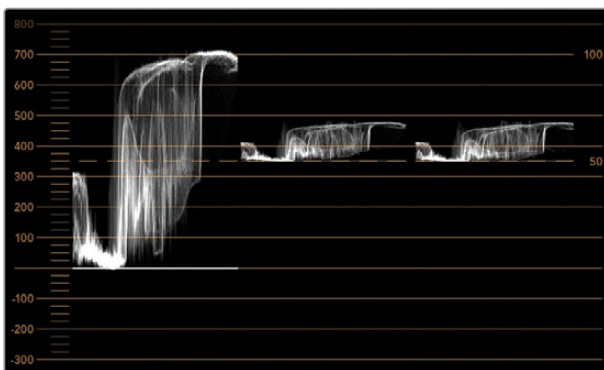

Visualização no padrão YUV.

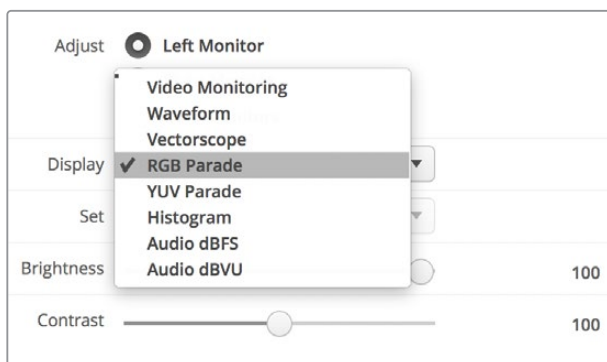

Selecione entre “RGB Parade” e “YUV Parade” no menu suspenso “Display” no Blackmagic SmartView Setup.

Display em Histograma

O display “Histogram” é mais conhecido entre designers gráficos e operadores de câmera. Ele exibe a distribuição de informações do branco para o preto e permite que você monitore de perto o tanto que os detalhes são perdidos nos brancos e pretos do vídeo. O display em histograma também permite visualizar os efeitos dos ajustes de gama no vídeo.

O vídeo preto é exibido na esquerda do display e os brancos na direita. Normalmente, todos os vídeos devem estar entre intervalos de 0% e 100% do display em histograma. Eles são cortados caso se encontrem abaixo de 0% ou acima de 100%. Filmar vídeos com perdas pode ser algo muito ruim, já que os detalhes nos pretos e brancos precisam ser preservados caso você queira fazer posteriormente a correção de cores em um ambiente controlado. Portanto, durante as filmagens, mantenha o vídeo acima do corte preto e abaixo do corte branco para que tenha mais liberdade na hora de ajustar as cores, sem que os brancos e pretos apareçam com menos contraste, saturação e detalhes.

Durante a correção de cores, pode ser que você decida cortar seu vídeo e, nesse caso, o display em histograma exibirá o efeito do corte e o tanto que está sendo cortado. Você pode até usar gama para criar um look semelhante, com menos perda, ao mesmo tempo que mantém mais detalhes.

Não é possível, porém, usar o display em histograma para verificar níveis ilegais, embora você possa ver pretos e brancos ilegais. O display em histograma não exibe cores, mas ele pode aparentar indicar níveis legais enquanto seu vídeo contém cores ilegais. Mais uma vez, o display no padrão RGB oferece a melhor maneira de identificar níveis ilegais, já que ele os exibe em elementos de cor e luminância do sinal de vídeo.

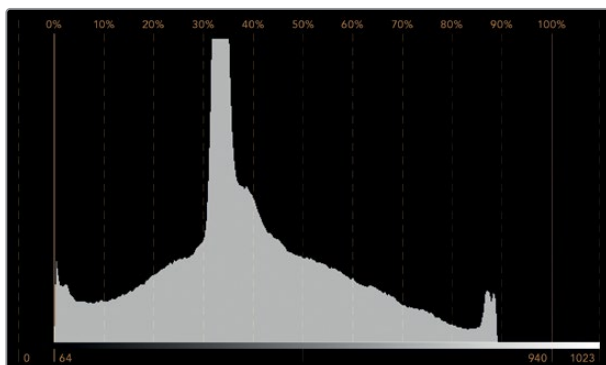

Configuração do display em histograma exibindo distribuição dos brancos para os pretos.

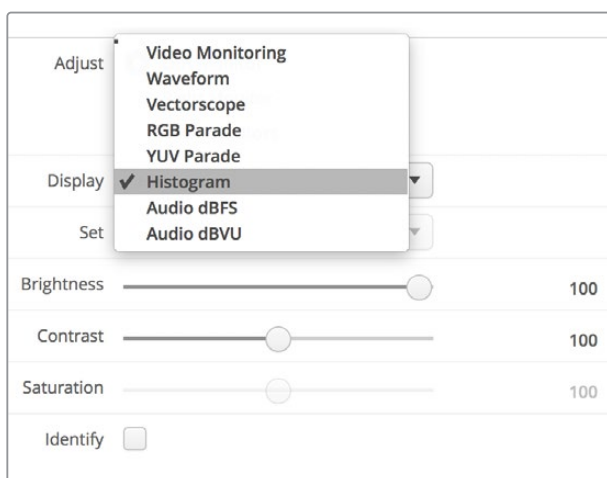

Selecione “Histogram” no menu suspenso “Display” no Blackmagic SmartView Setup.

Display com Medição de Áudio

O display com medição de áudio exibe os níveis de áudio embutidos do sinal de vídeo SDI. Até 16 canais de áudio embutidos são desembutados e, depois, exibidos no formato dBVU ou dBFS.

O indicador VU, que mostra os níveis médios do sinal, é fácil de usar e muito comum em equipamentos mais antigos. O VU é calibrado de acordo com a recomendação SMPTE de que um tom de teste de 1 kHz seja configurado como -20 dBFS.

O dBFS é, essencialmente, um medidor do sinal de áudio digital como um todo e é comum em equipamentos digitais modernos.

O escopo de áudio da direita é capaz de monitorar dois canais de áudio, os quais podem ser selecionados no menu suspenso "Set", como os canais 1 & 2, 3 & 4, etc. O escopo de áudio apresenta o áudio em uma visualização X-Y, assim você pode monitorar problemas no balanço de áudio, condições defasadas e se uma trilha de áudio é mono ou estéreo. O áudio mono deve aparecer como uma única linha vertical em fase, "In Phase". Se a linha estiver horizontal, significa que seu áudio está fora de fase, "Out of Phase", e poderia aplicar compensação (ex: perda de áudio) quando recebido por equipamentos downstream. A fase do áudio, "Audio Phase", é uma das avarias de áudio mais comuns em instalações grandes, onde os cabos podem ser conectados inadequadamente.

Ao monitorar sinais estéreos, a linha do escopo de áudio no lado direito se espalha para representar a diferença entre os canais de áudio esquerdo e direito. Quanto mais som estéreo na trilha de áudio, mais circular a linha aparecerá. Se o áudio tiver conteúdo estéreo mínimo, o estéreo aparecerá mais concentrado por volta do eixo vertical.

Áudios de diálogo tendem a aparecer como uma linha vertical, enquanto músicas com muito conteúdo estéreo farão com que o escopo seja exalado. Isso ocorre porque o áudio mono é L+R e é exibido no eixo vertical, enquanto o conteúdo estéreo é L-R e é exibido no eixo horizontal para mostrar a diferença do estéreo.

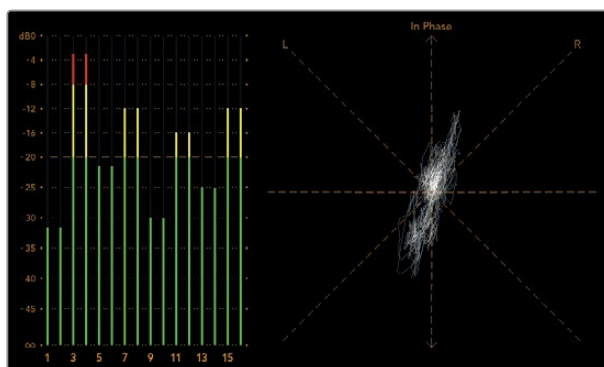

Display com medição de áudio mostrando os níveis de pico e o balanço de áudio.

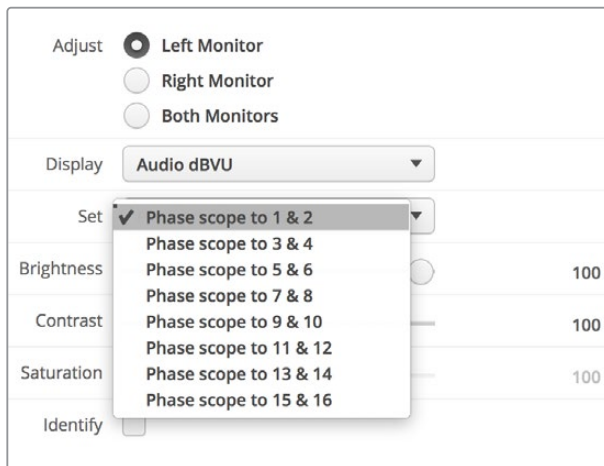

Use o menu suspenso “Set” para selecionar o par de canais de áudio a ser monitorado.

Conectar a uma Rede

Ao conectar um monitor SmartView ou SmartScope a uma rede, você pode ajustar as configurações do monitor de múltiplas unidades remotamente.

Apesar dos monitores SmartView e SmartScope exibirem vídeos sem a necessidade de qualquer configuração, os ajustes podem ser feitos antes da sua implementação. A configuração de rede pode ser realizada somente com o uso direto de uma conexão USB a um computador.

Ethernet Direta

A configuração remota de um monitor pode ocorrer através de uma conexão Ethernet direta ao seu computador. Nenhum switch de rede é necessário nesta configuração, o que é excelente caso precise fazer a instalação e configuração rapidamente. As unidades adicionais podem ser montadas em cascata usando a porta de saída Ethernet com loop-through ativa em cada unidade. A alimentação deve ser fornecida a todas as unidades montadas em cascata.

Caso queira conectar várias unidades sem usar os endereços IP da rede atual do seu estúdio, ou caso não tenha uma rede existente, basta conectá-las diretamente à porta Ethernet do seu computador. Esta também é uma maneira rápida de conectar as unidades SmartView e SmartScope via Ethernet, já que não precisa levar os cabos de volta a um switch de rede.

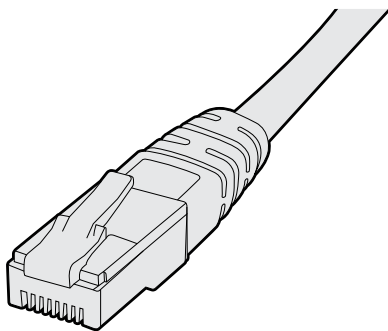

Conector Ethernet.

Switch de Rede Ethernet

Caso queira conectar várias unidades à rede do seu estúdio você precisará conectar somente um SmartView ou SmartScope ao switch de rede, enquanto o resto pode ser montado em cascata usando a porta de saída Ethernet com loop-through ativa em cada unidade para que apenas uma única porta no seu switch seja usada. Assim, você não precisará levar múltiplos cabos de volta a um switch de rede. A alimentação deve ser fornecida a todas as unidades para que a montagem em cascata funcione.

A conexão a um switch de rede permite que qualquer computador na rede altere as configurações de uma unidade. Qualquer computador laptop Mac ou Windows também é capaz de alterar as configurações através de uma conexão WiFi, se sua rede incluir um ponto de acesso sem fio.

Será necessário seguir os passos abaixo para conectar o SmartView ou SmartScope a uma rede baseada em IP de área local.

- 1 Conecte-se com segurança e ative a fonte de alimentação incluída na sua unidade.
- 2 Conecte a unidade a um switch de rede, ou diretamente a um computador, com um cabo Ethernet RJ45 padrão.

Diagrama de Conexão Ethernet Direta

Você pode conectar a porta Ethernet de um computador diretamente a uma unidade sem precisar de um switch de rede. As unidades adicionais podem ser montadas em cascata para que você não precise levar múltiplos cabos de volta a um switch de rede. A alimentação deve ser fornecida a todas as unidades.



Diagrama de Conexão de Switch de Rede Ethernet

Caso deseje conectar várias unidades à rede atual do seu estúdio, precisará conectar apenas uma unidade ao switch de rede. O resto pode ser montado em cascata para que você não precise levar múltiplos cabos de volta a um switch de rede. A alimentação deve ser fornecida a todas as unidades.

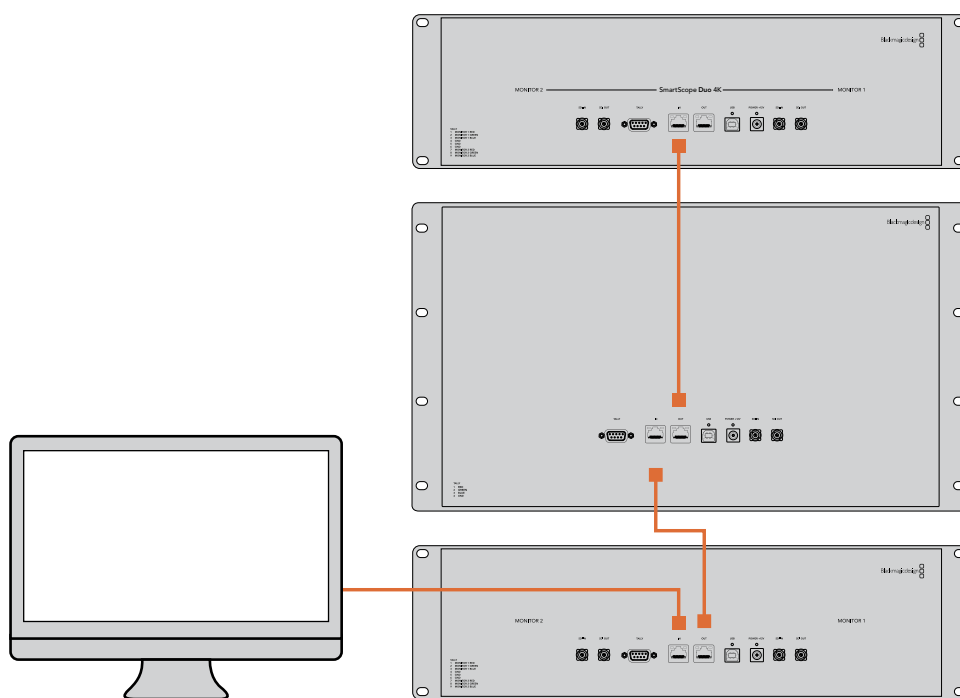
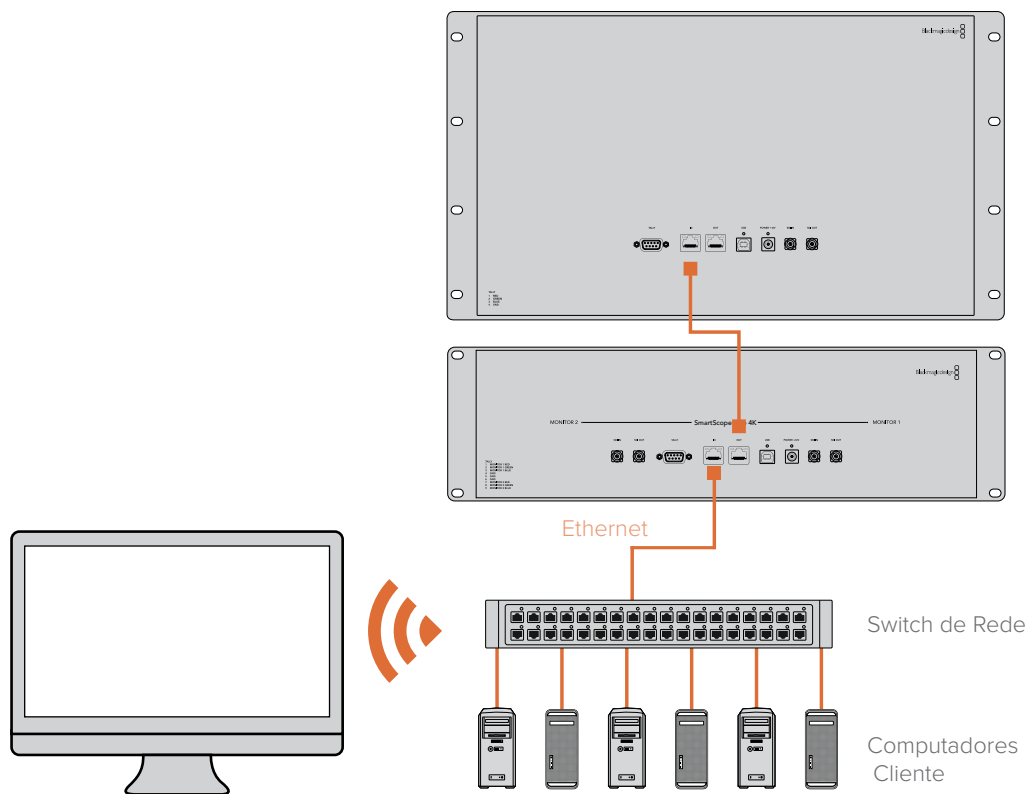

Ajustar Configurações de Rede

Configurações de Rede

Nome do Dispositivo

É recomendável alterar o nome do seu monitor para que cada unidade SmartView ou SmartScope seja identificada facilmente na rede, por exemplo “Câmeras de Campo 1 & 2”, “Saída de Multivisualização”, “Alimentações 4K” e etc.

Para mudar o nome do seu monitor, certifique-se de que ele esteja conectado via Ethernet ou USB. Inicie o Blackmagic SmartView Setup e clique no ícone de configuração abaixo do nome do seu monitor. Na página de configuração, clique em “Network” e edite o seu monitor localizado na seção “Details”. Se o software detectar um nome inválido, um ícone de aviso aparecerá próximo a ele à medida que você digita. Se o nome for válido, aparecerá um tique verde. Pressione a tecla “Return” no teclado do seu computador para confirmar a alteração do nome.

Configurações de Rede

Para fazer alterações na seção de configurações de rede no Blackmagic SmartView Setup, é necessário que o seu monitor Blackmagic esteja conectado ao computador via USB. As configurações de rede não podem ser alteradas via Ethernet.

Por padrão, o SmartView e o SmartScope usam DHCP para obter um endereço IP da sua rede automaticamente.

Na ausência de um servidor DHCP, pode ser que você queira habilitar o recurso “Internet Sharing” do macOS ou o recurso “Internet Connection Sharing” (ICS) do Windows 8.1 ou Windows 10, para fornecer endereços DHCP a quaisquer unidades diretamente fixadas. Isto evitará a necessidade de atribuir endereços IP estáticos manualmente a cada unidade. Você pode usar este recurso para fornecer endereços DHCP mesmo que seu computador não tenha uma conexão com a Internet. O compartilhamento da Internet é detalhado na seção de ajuda, “Help”, das documentações do macOS e Windows 8.1 e 10.

Se o DHCP não puder ser usado na sua configuração, opte por configurar o endereço usando “Static IP”. Para evitar o surgimento de um conflito de IP na sua rede, por favor solicite um endereço IP disponível ao seu administrador de sistema. Você precisará especificar um endereço IP único para cada unidade SmartView e SmartScope, assim como uma máscara de sub-rede comum. Não é necessário alterar o valor padrão no campo “Gateway” a menos que você pretenda conectar suas unidades a um gateway de rede, como um roteador de Internet.

Caso nenhum monitor SmartView ou SmartScope seja localizado na rede, pode ser que as unidades não tenham recebido endereços IP via DHCP e será necessário ajustar manualmente cada unidade com configurações de rede adequadas.

- 1 Conecte um monitor Blackmagic SmartView ou SmartScope ao seu computador via USB e inicie o Blackmagic SmartView Setup.
- 2 Seu monitor conectado será exibido automaticamente na página inicial do SmartView Setup e apresentará um ícone USB próximo ao seu nome.
- 3 Ajuste as configurações de rede do seu monitor.
- 4 Repita esses passos para todas as outras unidades que não receberam um endereço IP via DHCP.

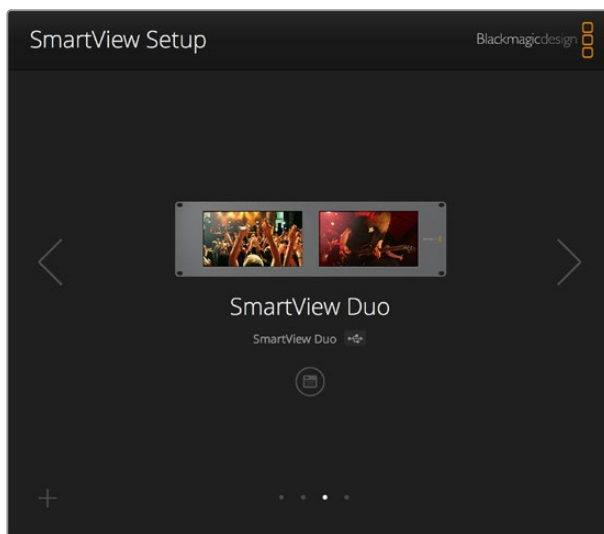

O ícone USB próximo ao nome do seu monitor mostra que o monitor está conectado ao seu computador via USB. Para fazer ajustes nas configurações de rede, seu monitor Blackmagic precisa estar conectado via USB.

The screenshot shows a 'Monitor Configure' window. It has a 'Details' section with 'Name: SmartView Duo' and 'Software Version: 4.0.1'. The 'Network Settings' section has 'IP setting:' with radio buttons for 'DHCP' and 'Static IP', where 'Static IP' is selected. Below this are input fields for 'IP Address: 192.168.10.42' (with a green checkmark), 'Subnet Mask: 255.255.255.0', and 'Gateway: 192.168.10.1'. At the bottom are 'Cancel' and 'Save' buttons.

As configurações de rede podem ser ajustadas para usar DHCP ou um endereço IP estático e podem ser alteradas apenas via USB.

Adicionar um Monitor Blackmagic

Se você já souber o endereço IP de um SmartView ou SmartScope Duo 4K, mas ele não aparecer automaticamente na página inicial do Blackmagic SmartView Setup, é possível adicionar o monitor manualmente. Para fazer isto:

- 1 Certifique-se de que o seu monitor Blackmagic esteja conectado via Ethernet. Clique no ícone “+” no canto inferior esquerdo para abrir a janela “Add a Blackmagic Monitor”.
- 2 Digite o endereço IP do monitor e clique em “Add”.
- 3 O software verificará a presença da unidade e a adicionará aos monitores Blackmagic incluídos na página inicial do SmartView Setup. Clique no ícone da seta direita para visualizar seu monitor recém-adicionado.

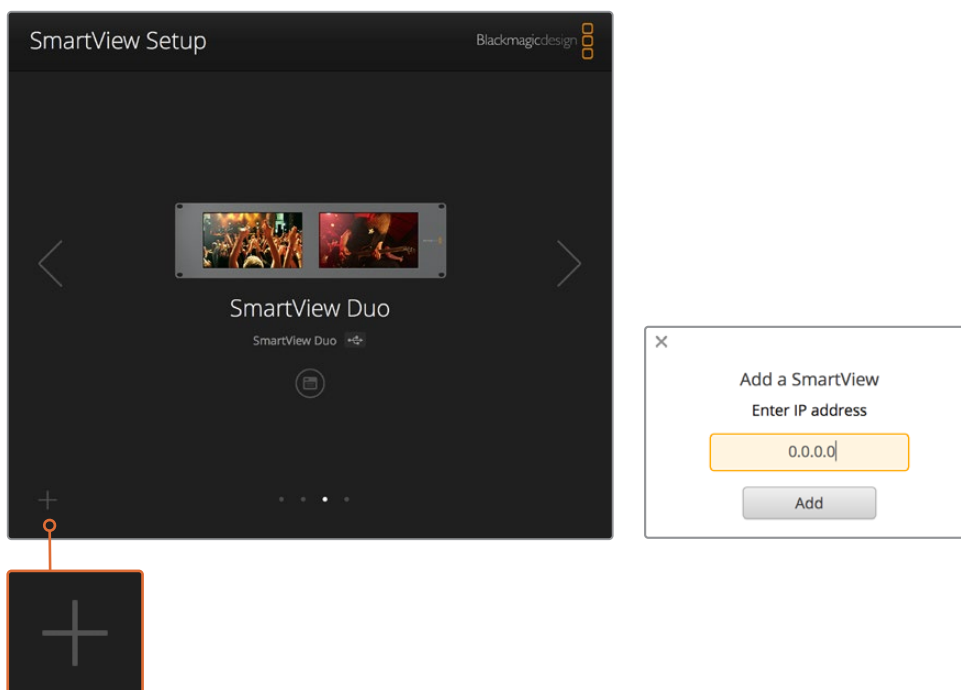

Você pode adicionar manualmente um monitor SmartView ou SmartScope à lista dos monitores conectados clicando no ícone "+" e inserindo o endereço IP do monitor.

Usar Sinalização

Conexões dos Pinos da Porta de Sinalização

A porta de sinalização do SmartView ou SmartView não precisa necessariamente estar conectada, portanto você pode ignorar esta seção caso não pretenda usar o recurso de sinalização.

As telas do SmartView e SmartScope contam com bordas de sinalização independentes em vermelho, verde ou azul, as quais podem ser usadas para indicar o status de um sinal de vídeo, como no ar, pré-visualização ou gravação.

A porta de sinalização D-sub de 9 pinos aceita sinais de fechamento de contato dos switchers e sistemas de automação. Por favor consulte o diagrama de conexões dos pinos de sinalização para informações sobre o cabeamento da porta de sinalização para uso com seu switcher ou sistema de automação.

A descrição do cabeamento da porta D de 9 pinos está impressa na traseira da unidade, mostrando os fechamentos de contato para exibir as bordas de sinalização vermelhas, verdes ou azuis em cada monitor independente.

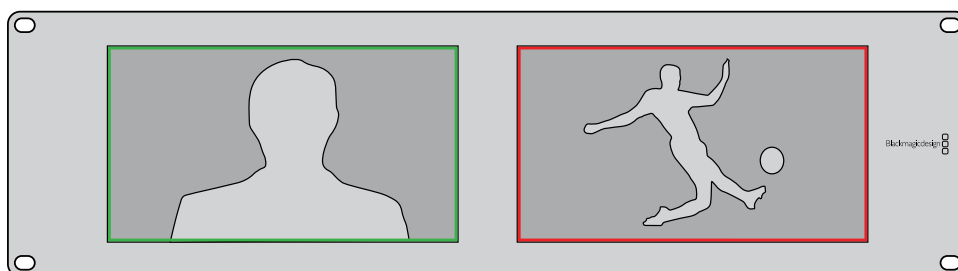

SmartView Duo exibindo bordas verdes e vermelhas.

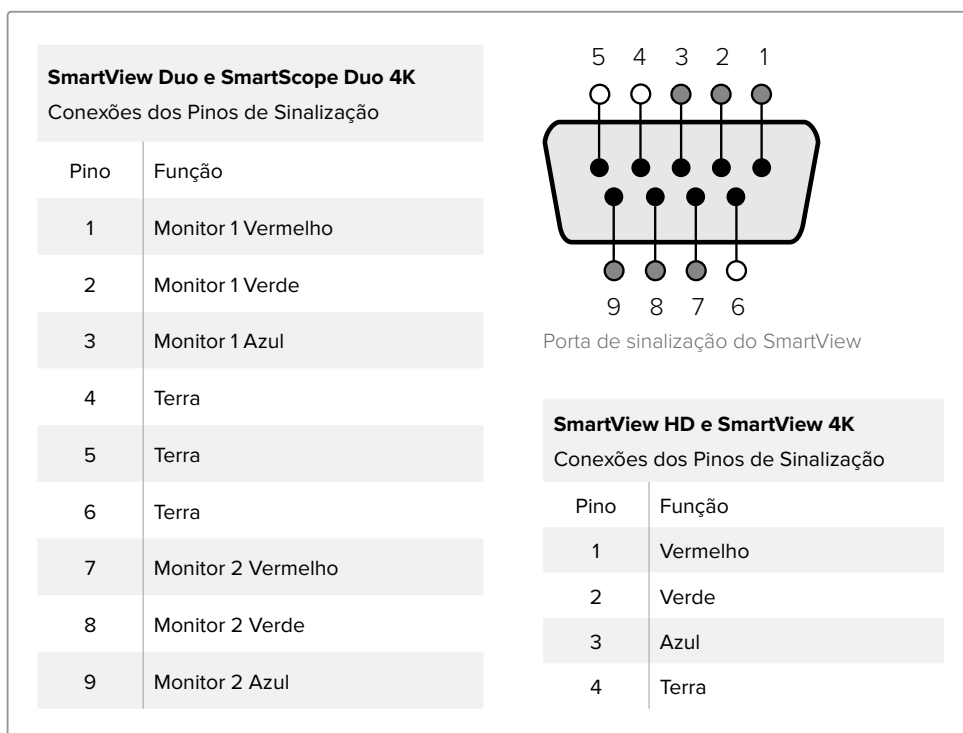

Otimizar o Ângulo de Visualização

Se os monitores SmartView Duo, SmartView HD ou SmartScope forem instalados em um rack de equipamentos muito alto, você deve inverter fisicamente as telas LCDs para obter o ângulo de visualização ideal.

As imagens exibidas nos LCDs corresponderão automaticamente à orientação correta ao detectarem a inversão. Uma chave de fenda pozidriv de número 02 é necessária para encaixar e desencaixar o painel frontal da sua montagem traseira. Trata-se de um processo simples e não envolve a abertura da montagem traseira.

O processo a seguir descreve como inverter a unidade e ao mesmo tempo manter o logotipo da Blackmagic Design na orientação correta no painel frontal. Uma chave de fenda pozidriv de número 02 é necessária.

- 1 Remova as chaves de fenda das laterais superior, inferior, esquerda e direita do painel frontal. O SmartView Duo e o SmartScope Duo 4K possuem 10 parafusos e o SmartView HD possui 18 parafusos.
- 2 Retire o painel frontal da montagem traseira, conforme a ilustração.
- 3 Inverta a montagem traseira.
- 4 Reencaixe o painel frontal na montagem traseira invertida.
- 5 Reencaixe os parafusos no chassi.

O seu SmartView ou SmartScope agora está pronto para ser instalado em um rack alto. Depois de ser aparafusado no rack, o SmartView continuará exibindo o ângulo de visualização ideal mesmo após sofrer impactos, pois não há botões giratórios externos ou ajustes que levem a manejos incorretos ou que fiquem frouxos.



É recomendável realizar um teste de inversão para verificar o ângulo de visualização ideal antes de aparafusar a sua unidade em um rack muito alto.

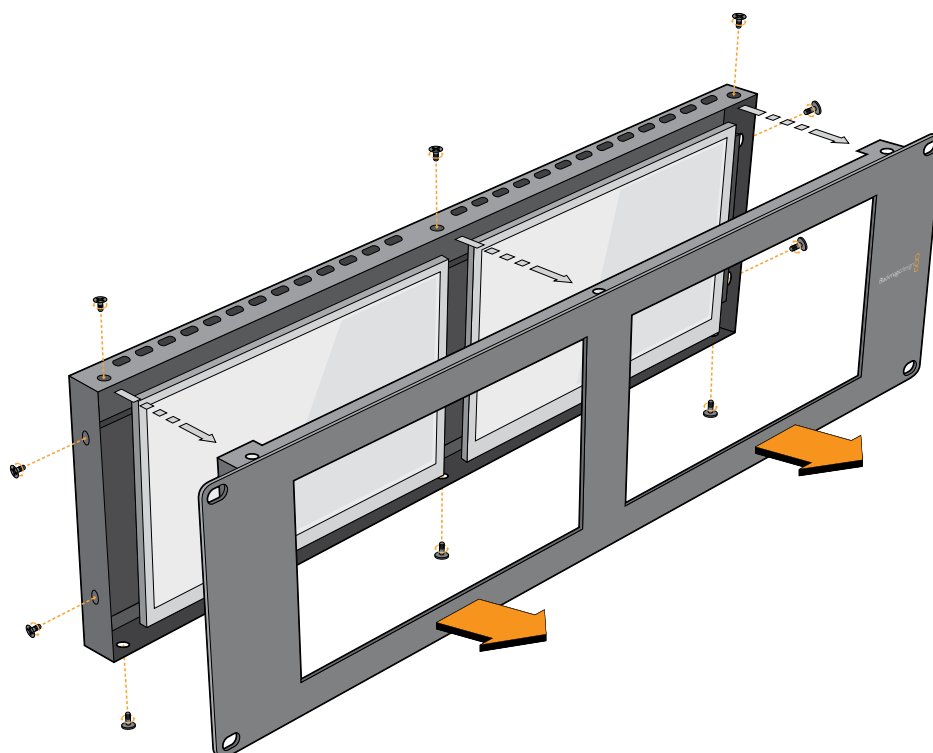

Remova todos os parafusos para retirar o painel frontal da montagem traseira.

Informações para Desenvolvedores

Desenvolver Software Personalizado com Hardware da Blackmagic Design

O Blackmagic SmartView Ethernet Protocol permite que os desenvolvedores controlem remotamente hardware do Blackmagic SmartView e SmartScope com seus próprios programas personalizados. O Blackmagic SmartView Ethernet Protocol é um protocolo de controle com status baseado em texto.

Baixar o SmartView Ethernet Protocol

O Blackmagic SmartView Ethernet Protocol é gratuito. Ele está incluído neste manual SmartView & SmartScope e está disponível para download em www.blackmagicdesign.com/br/support.

Juntar-se à Lista de Desenvolvedores da Blackmagic Design

A lista de emails de desenvolvedores da Blackmagic foi criada para discussões técnicas sobre as tecnologias usadas pela Blackmagic Design, como QuickTime, Core Media, DirectShow, codecs, APIs, SDKs e etc. Esta lista de emails é gratuita e funciona como um fórum onde os desenvolvedores podem trocar ideias. Qualquer inscrito pode participar e os engenheiros da Blackmagic Design também podem vir a participar, se necessário. Você pode se inscrever na lista de emails em <http://lists.blackmagicdesign.com/mailman/listinfo/bmd-developer>.

Em alguns casos, solicitaremos uma breve descrição do software em desenvolvimento, caso o seu nome de domínio não informe claramente que sua organização desenvolve software de vídeo. Por favor, não se sinta ofendido se isto acontecer, pois estamos apenas tentando evitar spams, vírus, assim como clientes com perguntas não relacionadas a desenvolvedores e agências de emprego ou vendedores tentando promover produtos na lista. Esta lista é voltada somente para desenvolvedores.

Contactar o Suporte Técnico a Desenvolvedores da Blackmagic Design

Você também pode entrar em contato conosco via developer@blackmagicdesign.com, caso tenha dúvidas relevantes a desenvolvedores ou deseje fazer perguntas fora da lista.



Blackmagic 2K Format – Visão Geral

Os produtos Blackmagic Design são compatíveis com vídeos 3G-SDI, o que permite uma taxa de dados duas vezes maior que a de vídeos HD-SDI tradicionais. Achamos que seria uma ótima ideia adicionar suporte a filmes em 2K, via tecnologia 3G-SDI, para simplificar fluxos de trabalho de longas-metragens. Com os sistemas de edição da Blackmagic Design alcançando popularidade no mundo todo, agora milhares de pessoas podem se beneficiar da revolução no fluxo de trabalho de longas-metragens.

Estas informações incluem tudo que os desenvolvedores de produtos precisam saber para a criação de equipamentos SDI em 2K nativo. Obviamente, todos os produtos Blackmagic são atualizáveis, portanto caso a indústria televisiva adote um padrão alternativo de filme baseado em SDI, poderemos adicionar suporte a ele também!

Estrutura de Quadro

- Transmitido a 23.98, 24 ou 25 quadros por segundo como um Progressive Segmented Frame.
- O vídeo ativo possui 2048 pixels de largura por 1556 linhas de profundidade.
- Número total de linhas por quadro: 1650.
- Número de palavras ativas por linha: 1535. Uma palavra consiste em uma amostra de 10 bits para cada um dos quatro fluxos de dados, como um total de 40 bits. Consulte o diagrama nomeado Blackmagic 2K Format - Formato do Fluxo de Dados.
- Número total de linhas ativas: 1556.
- Número de palavras por linha: 1875 para 23.98/24 Hz e 1800 para 25 Hz.
- Campos por quadro: 2825 linhas cada.
- As linhas ativas são localizadas nas linhas 16-793 (campo 1) e 841-1618 (campo 2).

Estrutura de Transporte

- Baseado no mapeamento de enlace duplo SMPTE 372M e suporte SMPTE 425M-B para o mapeamento SMPTE 372M em um enlace único a 3 Gb/s.
- Sinais de referência de cronometragem, inserção de CRC e número de linha ocorrem conforme mencionado acima.
- Durante o vídeo ativo, dados vermelho, verde e azul de 10 bits são enviados na sequência a seguir.
- Dados ANC opcionais são inseridos em ambas interfaces virtuais.
- No momento, somente os dados de áudio são incluídos: de acordo com a inserção de áudio HD padrão (SMPTE S299M), os pacotes de dados de áudio são carregados no fluxo de dados 2 e os pacotes de controle de áudio são carregados no fluxo de dado 1.
 - Fluxo de dado 1: Green_1, Green_2, Green_3, Green_5...Green_2047
 - Fluxo de dado 2: Blue_1, Blue_2, Green_4, Blue_5...Green_2048.
 - Fluxo de dado 3: Red_1, Blue_3, Blue_4, Red_5...Blue_2048.
 - Fluxo de dado 4: Red_2, Red_3, Red_4, Red_6...Red_2048.

Blackmagic 2K Format – Referência de Cronometragem Vertical

Este diagrama mostra os detalhes de cronometragem vertical com números de linha e campos, bits vertical e horizontal para os códigos de sinal de referência de cronometragem.

		Field 1					Active					
F	1	0	0	0	0	0	0	0	0	0	0	0
V	1	1	1	1	1	1	0	0	0	0	1	1
LINE #	1650	1	2	...	14	15	16	...	792	793	...	825

		Field 2					Active					
F	0	1	1	1	1	1	1	1	1	1	1	1
V	1	1	1	1	1	1	0	0	0	0	1	1
LINE #	825	826	827	...	839	840	841	...	1617	1618	...	1650

Blackmagic 2K Format – Formato de Fluxo de Dados

Este diagrama mostra os formatos dos fluxos de dados próximos da seção de dados ANC opcionais da linha horizontal. Observe que cada pixel ativo recebe até três amostras.

Palavra# 25 PsF	Palavra# 23.98/24 PsF	Fluxo de Dados 4	Fluxo de Dados 3	Fluxo de Dados 2	Fluxo de Dados 1
1795	1870	R2042	R2041	B2041	G2041
1796	1871	R2043	B2043	B2042	G2042
1797	1872	R2044	B2044	G2044	G2043
1798	1873	R2046	R2045	B2045	G2045
1799	1874	R2047	B2047	B2046	G2046
1800	1875	R2048	B2048	G2048	G2047
1	1	EAV(3FFh)	EAV(3FFh)	EAV(3FFh)	EAV(3FFh)
2	2	EAV(000h)	EAV(000h)	EAV(000h)	EAV(000h)
3	3	EAV(000h)	EAV(000h)	EAV(000h)	EAV(000h)
4	4	EAV(XYZh)	EAV(XYZh)	EAV(XYZh)	EAV(XYZh)
5	5	LN0	LN0	LN0	LN0
6	6	LN1	LN1	LN1	LN1
7	7	CRC0	CRC0	CRC0	CRC0
8	8	CRC1	CRC1	CRC1	CRC1
9	9	200	040	Dados de Áudio/ANC	Dados de Áudio/ANC
...		
260	335	200	040		
261	336	EAV(3FFh)	SAV(3FFh)	EAV(3FFh)	EAV(3FFh)
262	337	SAV(000h)	SAV(000h)	SAV(000h)	SAV(000h)
263	338	SAV(000h)	SAV(000h)	SAV(000h)	SAV(000h)
264	339	SAV(XYZh)	SAV(XYZh)	SAV(XYZh)	SAV(XYZh)
265	340	R2	R1	B1	G1
266	341	R3	B3	B2	G2
267	342	R4	B4	G4	G3
268	343	R6	R5	B5	G5

Blackmagic SmartView Ethernet Protocol v1.3

Resumo

O Blackmagic SmartView Ethernet Protocol é um protocolo de controle e status baseado em texto, muito semelhante ao protocolo Videohub em termos de estrutura, acessado pela conexão com a porta 9992 TCP em um dispositivo SmartView ou SmartScope.

Após conexão, o SmartView ou SmartScope envia um despejo completo do estado do dispositivo. Depois do despejo inicial, as alterações do estado são enviadas de maneira assíncrona.

O dispositivo envia informações em blocos, os quais contêm um cabeçalho identificador, seguido de dois-pontos. Um bloco pode abranger múltiplas linhas e é encerrado por uma linha em branco.

Para flexibilidade em relação às alterações futuras do protocolo, os clientes devem ignorar os blocos que eles não reconhecem, até a linha em branco à direita. Nos blocos reconhecidos, os clientes devem ignorar as linhas que eles não reconhecem.

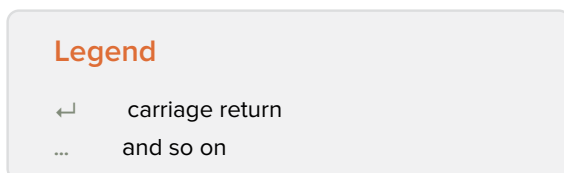

A versão 1.3 do Blackmagic SmartView Ethernet Protocol foi lançada com o software SmartView 1.3.

Preâmbulo do Protocolo

O primeiro bloco enviado pelo SmartView Server é sempre o preâmbulo do protocolo:

```
PROTOCOL PREAMBLE:↵
Version 1.3 ↵
↵
```

O campo da versão indica a versão do protocolo. Quando o protocolo é alterado de maneira compatível, o número da versão de manutenção é atualizado. Se alterações incompatíveis são feitas, o número da versão principal é atualizado.

Informações do Dispositivo

O bloco a seguir contém informações gerais sobre o dispositivo SmartView ou SmartScope conectado.

```
SMARTVIEW DEVICE:↵
Model: SmartView Duo↵
Hostname: stagefront.studio.example.com↵
Name: StageFront↵
Monitors: 2↵
Inverted: false↵
↵
```

Este exemplo exibe a saída para um dispositivo SmartView Duo, que possui duas telas LCDs. O sinalizador INVERTED indica se o dispositivo detectou se ele foi inserido em uma configuração invertida para otimizar o ângulo de visualização da tela LCD.

Configuração de Rede

O próximo bloco mostra a configuração de rede TCP/IP:

```
NETWORK:↵
Dynamic IP: true↵
Static address: 192.168.2.2↵
Static netmask: 255.255.255.0↵
Static gateway: 192.168.2.1↵
Current address: 192.168.1.101↵
Current netmask: 255.255.255.0↵
Current gateway: 192.168.1.1↵
↵
```

As configurações de rede com o prefixo CURRENT mostram as configurações TCP/IP ativas, e elas são somente leitura. As definições CURRENT refletem a configuração DHCP ou estática, dependendo do sinalizador DYNAMIC IP.

Alterar Configurações de Rede

A rede pode ser configurada para usar uma configuração DHCP ou estática. Como habilitar DHCP:

```
NETWORK:↵
Dynamic IP: true↵
↵
```

Para configurar um endereço IP fixo, forneça todos os parâmetros estáticos:

```
NETWORK:↵
Dynamic IP: false↵
Static address: 192.168.2.2↵
Static netmask: 255.255.255.0↵
Static gateway: 192.168.2.1↵
↵
```

Os parâmetros com o prefixo CURRENT são somente leitura e mostram a configuração ativa, independentemente da configuração ser estática ou dinâmica.

A alteração do nome do dispositivo, ou de quaisquer configurações de rede, gerarão a queda da conexão IP. O dispositivo reiniciará sua rede e informará seu novo nome na rede.

Ajustar Configurações do Monitor

As configurações do display para cada monitor são especificadas individualmente. Um ou mais monitores podem ser modificados ao mesmo tempo e múltiplas configurações podem ser fornecidas em um bloco.

O intervalo válido para valores numéricos é 0-255. As propriedades CONTRAST e SATURATION são centradas em zero, então o valor normal é 127, de forma que a imagem exibida é a mesma que a original. Um valor maior que 127 em cada canal gerará um aumento no contraste ou na saturação e, de maneira semelhante, um valor menor que 127 gerará uma redução.

Por exemplo, para configurar o brilho a 50% e para remover a saturação da imagem para Preto & Branco:

```
MONITOR A:↵
Brightness: 127↵
Saturation: 0↵
↵
```

Exibir SD em 16:9

O comando a seguir configura vídeos em definição padrão para exibição em 16:9:

```
MONITOR A:↵  
WidescreenSD: ON↵
```

Exibir SD em 4:3

O comando a seguir configura vídeos em definição padrão para exibição em 4:3:

```
MONITOR A:↵  
WidescreenSD: OFF↵
```

Configurações de Identificação e Sinalização

O sinalizador Identify é transitório e fará com que uma borda branca seja exibida ao redor de toda a imagem por uma duração de 15 segundos, sendo restaurado depois. Este recurso tem como objetivo principal a identificação do monitor que está sendo configurado no momento ao ser montado em um rack com múltiplas unidades. Como habilitar:

```
MONITOR A:↵  
Identify: true↵  
↵
```

A borda IDENTIFY substituirá temporariamente quaisquer outras configurações de borda vigentes.

A propriedade BORDER pode ser usada para configurar de forma programática as bordas de sinalização coloridas sem fio com uma das cores primárias: RED, GREEN, BLUE, WHITE ou NONE. Esta configuração pode ser substituída pelos sinais de sinalização elétricos na entrada DB-9 do próprio dispositivo. Por exemplo, para configurar a sinalização sem fio como verde:

```
MONITOR B:↵  
Border: green↵  
↵
```

A sinalização por fio sempre substituirá a sinalização sem fio. O relatório de estado completo sempre indicará a atual borda válida.

Configurações do SmartScope

No SmartScope Duo 4K, cada monitor pode ser configurado para exibir um escopo diferente. Os valores para ativar escopos específicos são mapeados como a seguir:

- AudioDbfs
- AudioDbvu
- Histogram
- ParadeRGB
- ParadeYUV
- Picture (o mesmo que Video Monitor)
- Vector100
- Vector75
- WaveformLuma

```
MONITOR A:↵  
ScopeMode: Picture↵  
↵
```

No exemplo acima, Monitor A foi configurado como um monitor de vídeo.

Exibir SD em 16:9

Como configurar o modo Video Monitor para exibir vídeos em definição padrão em 16:9:

```
MONITOR A:↵  
ScopeMode: Picture↵  
WidescreenSD: ON↵
```

Exibir SD em 4:3

Como configurar o modo Video Monitor para exibir vídeos em definição padrão em 4:3:

```
MONITOR A:↵  
ScopeMode: Picture↵  
WidescreenSD: OFF↵
```

Ao configurar um dos monitores do SmartScope Duo 4K como medidores de áudio, é possível também selecionar quais canais deseja exibir. Os valores para selecionar os canais de áudio são mapeados da seguinte maneira:

- 0: Canais 1 e 2
- 1: Canais 3 e 4
- 2: Canais 5 e 6
- 3: Canais 7 e 8
- 4: Canais 9 e 10
- 5: Canais 11 e 12
- 6: Canais 13 e 14
- 7: Canais 15 e 16

```
MONITOR B:↵  
ScopeMode: AudioDbvu↵  
AudioChannel: 0↵
```

```
↵
```

No exemplo acima, o Monitor B foi selecionado para exibir medidores de áudio em Dbvu com os canais de áudio 1 e 2 selecionados para o medidor de fase.

Selecionar LUTs para o SmartView 4K

Como selecionar LUTs 3D usando SmartView 4K:

```
MONITOR A:↵  
LUT: 0LUT 1  
1LUT 2  
NONE DISABLE
```

```
↵
```

```
↵
```

Ajuda

Obter Ajuda

Há quatro maneiras de obter ajuda:

- 1** Acesse a Central de Suporte Técnico da Blackmagic Design em www.blackmagicdesign.com/br/support para as informações de suporte mais recentes.
- 2** Ligue para o seu revendedor da Blackmagic Design.
- 3** Seu revendedor local terá as últimas atualizações técnicas da Blackmagic Design e poderá fornecer assistência imediata. Também recomendamos que você verifique as opções de suporte oferecidas pelo revendedor, pois ele pode organizar diversos planos de suporte baseados nas exigências do seu fluxo de trabalho.
- 4** Outra opção é nos enviar um email com suas dúvidas usando o botão “Enviar email” em www.blackmagicdesign.com/br/support.
- 5** Ligue para um escritório de suporte da Blackmagic Design. Você pode encontrar o escritório mais próximo clicando no botão “Encontre a sua equipe de suporte local” na parte inferior da página de suporte.

Por favor nos forneça o máximo de informação possível sobre seu problema técnico e especificações do sistema para que possamos encontrar uma resposta para o seu problema o quanto antes.

Informações Regulatórias



Descarte de Resíduos de Equipamentos Elétricos e Eletrônicos na União Europeia

O símbolo no produto indica que este equipamento não pode ser eliminado com outros materiais residuais. Para descartar seus resíduos de equipamento, ele deve ser entregue a um ponto de coleta designado para reciclagem. A coleta separada e a reciclagem dos seus resíduos de equipamento no momento da eliminação ajudarão a preservar os recursos naturais e a garantir que sejam reciclados de uma maneira que proteja a saúde humana e o meio ambiente. Para mais informações sobre onde você pode eliminar os resíduos do seu equipamento para reciclagem, por favor contacte a agência de reciclagem local da sua cidade ou o revendedor do produto adquirido.



Este equipamento foi testado e respeita os limites para um dispositivo digital Classe A, conforme a Parte 15 das normas da FCC. Esses limites foram criados para fornecer proteção razoável contra interferências nocivas quando o equipamento é operado em um ambiente comercial. Este equipamento gera, usa e pode irradiar energia de radiofrequência e, se não for instalado ou usado de acordo com as instruções, poderá causar interferências nocivas nas comunicações via rádio. A operação deste produto em uma área residencial pode causar interferência nociva, nesse caso o usuário será solicitado a corrigir a interferência às suas próprias custas.

A operação está sujeita às duas condições a seguir:

- 1 Este dispositivo não poderá causar interferência nociva.
- 2 Este dispositivo deve aceitar qualquer interferência recebida, incluindo interferência que possa causar uma operação indesejada.

—



MSIP-REM-BMD-201410001
MSIP-REM-BMD-20150327
MSIP-REM-BMD-201702004
MSIP-REM-BMD-201702005

Norma Canadense ISED

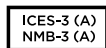

Este dispositivo está em conformidade com os padrões do Canadá para equipamentos digitais de Classe A.

Quaisquer modificações ou utilização deste produto fora dos limites previstos poderão anular a conformidade com estas normas.

A conexão com interfaces HDMI deve ser feita com cabos HDMI protegidos de alta qualidade.

Este equipamento foi testado para fins de cumprimento com a sua utilização pretendida em um ambiente comercial. Se o equipamento for usado em um ambiente doméstico, poderá causar interferência radioelétrica.

Informações de Segurança

Para proteção contra choque elétrico, o equipamento deve estar conectado à uma tomada com conexão de aterramento de proteção. Em caso de dúvida, consulte um eletricista qualificado.

Para reduzir o risco de choque elétrico, não exponha este equipamento a pingos ou respingos.

O produto é adequado para uso em locais tropicais com temperatura ambiente de até 40°C.

Certifique-se de que ventilação adequada seja fornecida ao redor do produto e não esteja restringida.

Ao montar o produto em rack, certifique-se de que a ventilação não esteja limitada por equipamentos adjacentes.

Não há componentes internos reparáveis pelo operador. Solicite o serviço de manutenção à assistência técnica local da Blackmagic Design.

Alguns produtos têm os recursos de conexão para módulos transceptores de fibra óptica com fator de forma SFP. Use apenas módulos SFP ópticos de Laser de classe 1.

Módulos SFP recomendados pela Blackmagic Design:

- **3G-SDI:** PL-4F20-311C
- **6G-SDI:** PL-8F10-311C
- **12G-SDI:** PL-TG10-311C



Use-o apenas em altitudes inferiores a 2000 m acima do nível do mar.

Declaração do Estado da Califórnia

Este produto pode expô-lo a produtos químicos, tais como vestígios de bifenilos polibromados dentro de peças de plástico, que é conhecido no estado da Califórnia por causar câncer e defeitos congênitos ou outros danos reprodutivos.

Para mais informações, visite www.P65Warnings.ca.gov.

Garantia

12 Meses de Garantia Limitada

A Blackmagic Design garante que este produto estará isento de quaisquer defeitos de materiais e fabricação por um período de 12 meses a partir da data de compra. Se o produto revelar-se defeituoso durante este período de garantia, a Blackmagic Design, a seu critério, consertará o produto defeituoso sem cobrança pelos componentes e mão-de-obra, ou fornecerá a substituição em troca pelo produto defeituoso.

Para obter o serviço sob esta garantia você, o Consumidor, deve notificar a Blackmagic Design do defeito antes da expiração do período de garantia e tomar as providências necessárias para o desempenho do serviço. O Consumidor é responsável pelo empacotamento e envio do produto defeituoso para um centro de assistência designado pela Blackmagic Design com os custos de envio pré-pagos. O Consumidor é responsável pelo pagamento de todos os custos de envio, seguro, taxas, impostos e quaisquer outros custos para os produtos que forem devolvidos por qualquer razão.

Esta garantia não aplica-se a defeitos, falhas ou danos causados por uso inadequado ou manutenção e cuidado inadequado ou impróprio. A Blackmagic Design não é obrigada a fornecer serviços sob esta garantia: a) para consertar danos causados por tentativas de instalar, consertar ou fornecer assistência técnica ao produto por pessoas que não sejam representantes da Blackmagic Design, b) para consertar danos causados por uso ou conexão imprópria a equipamentos não compatíveis, c) para consertar danos ou falhas causadas pelo uso de componentes ou materiais que não são da Blackmagic Design, d) para fornecer assistência técnica de um produto que foi modificado ou integrado a outros produtos quando o efeito de tal modificação ou integração aumenta o tempo ou a dificuldade da assistência técnica do serviço. ESTA GARANTIA É FORNECIDA PELA BLACKMAGIC DESIGN NO LUGAR DE QUAISQUER OUTRAS GARANTIAS, EXPLÍCITAS OU IMPLÍCITAS. A BLACKMAGIC DESIGN E SEUS FORNECEDORES NEGAM QUAISQUER GARANTIAS IMPLÍCITAS DE COMERCIALIZAÇÃO OU ADEQUAÇÃO A UMA FINALIDADE ESPECÍFICA. A RESPONSABILIDADE DA BLACKMAGIC DESIGN DE CONSERTAR OU SUBSTITUIR PRODUTOS DEFEITUOSOS É A ÚNICA E EXCLUSIVA MEDIDA FORNECIDA AO CONSUMIDOR PARA QUAISQUER DANOS INDIRETOS, ESPECIAIS OU ACIDENTAIS INDEPENDENTEMENTE DA BLACKMAGIC DESIGN OU DO FORNECEDOR TIVER INFORMAÇÃO PRÉVIA SOBRE A POSSIBILIDADE DE TAIS DANOS. A BLACKMAGIC DESIGN NÃO É RESPONSÁVEL POR QUAISQUER USOS ILEGAIS DO EQUIPAMENTO PELO CONSUMIDOR. A BLACKMAGIC NÃO É RESPONSÁVEL POR QUAISQUER DANOS CAUSADOS PELO USO DESTE PRODUTO. O USUÁRIO DEVE OPERAR ESTE PRODUTO POR CONTA E RISCO PRÓPRIOS

© Direitos autorais 2020 Blackmagic Design. Todos os direitos reservados. 'Blackmagic Design', 'DeckLink', 'HDLink', 'Workgroup Videohub', 'Multibrige Pro', 'Multibrige Extreme', 'Intensity' e 'Leading the creative video revolution' são marcas comerciais registradas nos Estados Unidos e em outros países. Todos os outros nomes de empresas e produtos podem ser marcas comerciais de suas respectivas empresas com as quais elas são associadas.



Kurulum ve Kullanım Kılavuzu

SmartView & SmartScope

Eylül 2020

Türkçe



Hoş Geldiniz

Herkesin en yüksek kalitedeki videoya erişim sağlamasını mümkün kılarak, televizyon endüstrisinin tam anlamıyla yaratıcı bir endüstri olmasına ilişkin hayalimizi paylaştığınızı umuyoruz.

Video izleme imkanı, bir tesisin her yerinde gereklidir. SmartView 4K bir native 4K LCD'ye sahip olduğundan, Ultra HD videoyu tam çözünürlükte izleyebilirsiniz. Buna ek olarak, ayarları hızla değiştirmenize olanak veren bir kontrol paneli ile şık 6RU kasaya sahiptir. SmartView HD bir inçten daha az bir incelikte, inanılmaz 6RU rack kasada 17 inçlik bir LCD sunar. SmartView Duo; bir inçten daha ince olan 3RU rack kasada, birbirinden tamamen bağımsız iki adet zarif 8 inç LCD sunar. SmartScope Duo 4K, dalga şekli (waveform) skop işlevselliği olan, iki adet bağımsız 8 inç LCD içerdiğinden, video seviyelerinizi anında izleyebilirsiniz. Tüm SmartView monitörleri, 3G-SDI yoluyla SD, HD ve 2K videoyu destekler. SmartScope Duo 4K ve SmartView 4K; sırasıyla 6G-SDI ve 12G-SDI aracılığıyla, Ultra HD 4K videoyu destekler.

Video izleme çözümlerimiz; kutudan çıktığı haliyle kullanılmaya hazır olarak tasarlanmıştır. Blackmagic SmartView kurulum yazılımımız, kullanıcıya kolay ve sezgisel bir yapılandırma aracı sunar.

Bu kullanım kılavuzu, SmartView ve SmartScope ürünlerinizin kurulumu için ihtiyacınız olan tüm bilgileri içerir. Ancak IP adresleri hakkında veya bilgisayar ağlarına ilişkin bilgi sahibi değilseniz, bir teknik asistandan yardım istemenizde yarar vardır. SmartView ve SmartScope ürünlerinin kurulumu kolaydır fakat, kurulumunu yaptıktan sonra ayarlamamız gerekebilecek bir kaç tane, kısmen teknik olan seçenekler bulunmaktadır.

Kurulumu tamamlamanızın aşağı yukarı 5 dakika sürmesini bekliyoruz. Lütfen www.blackmagicdesign.com/tr adresinden internet sitemizi ziyaret ederek, bu kılavuz ile SmartView yazılımının en son güncellemelerini indirmek için destek sayfasını tıklayınız. Son olarak, yeni güncellemeleri size duyurabilmemiz için, bilgisayarınıza yazılım güncellemeleri indirirken, ünitenizi sitemize kaydetmenizi rica ediyoruz. Sürekli yeni özellikler ve geliştirmeler için çaba içinde olduğumuzdan, yorumlarınızı almaktan mutluluk duyarız.

Grant Petty

CEO Blackmagic Design

İçindekiler

SmartView & SmartScope

Başlarken	405
SmartView ve SmartScope ile Tanışın	405
Video Kaynaklarının Takılması	406
Bilgisayarınızın Takılması	406
Blackmagic SmartView Setup Yazılımının Yüklenilmesi	407
Blackmagic SmartView Setup Yazılımının Kullanımı	408
Yazılımın Güncellenmesi	408
Monitör Ayarlarının Değiştirilmesi	408
Tally Kontrolünü Etkinleştir	411
SmartView 4K'nın Kullanımı	411
Blackmagic SmartView 4K ile Tanışın	411
Kontrol Panel Butonları	412
Blackmagic SmartView Setup Kullanılarak 3D LUT'ların Yüklenmesi	414
SmartScope Duo 4K Kullanımı	415
Blackmagic SmartScope Nedir?	415
Video İzleme Ekranı	416
Waveform (Dalga Şekli) Ekranı	417
Vektörskop Ekranı	418
Parade Ekranı	419
Histogram Ekranı	421
Ses Göstergeleri Ekranı	422
Bir Ağa Bağlanırken	423
Doğrudan Ethernet Bağlantısı	423
Ethernet Ağ Anahtarı	424
Ağ Ayarlarının Değiştirilmesi	425
Ağ Ayarları	425
Bir Blackmagic Monitörünün İlave Edilmesi	427
Tally Özelliğinin Kullanılması	428
Tally Port Pim Bağlantıları	428
İzleme Açısının Optimize Edilmesi	429
Yazılım Geliştirici Bilgileri	431
Blackmagic 2K Formatı – Genel Tanıtım	431
Blackmagic 2K Format – Vertical Timing Reference (Dikey Zamanlama Referansı)	432
Blackmagic 2K Format – Data Stream Format	433
Blackmagic SmartView Ethernet Protocol v1.3	434
Yardım	438
Mevzuata İlişkin Bildirimler	439
Güvenlik Bilgileri	440
Garanti	441

Başlarken

SmartView ve SmartScope ile Tanışın

SmartView monitörleri; rack bazlı izleme kurulumuna ihtiyacı olan her tesis için idealdir. Kurulumunuzu yapıp ürünlerinizi kullanmaya başlamanız için yapmanız gereken tek şey, ürünleri güç kaynağına takmak ve bir SDI kaynağını bağlamaktır.

SmartView 4K, 15.6 inç 4K LCD ekrana sahip olduğundan SD, HD veya Ultra HD videoyu native 3840x2160 piksel çözünürlükte izleyebilirsiniz. Ön kontrol panel butonları sayesinde; girişleri kolayca seçebilir, ekran parlaklığını ayarlayabilir, mavi kanaldaki gürültü seviyesini gözden geçirebilir, blanking (karartma) bilgilerini izleyebilir, 3D LUT uygulayabilir ve daha fazlasını yapabilirsiniz.

SmartView HD; güvenle tam çözünürlüklü HD izleme için mükemmel bir 17 inç HD LCD ekrana sahiptir.

SmartView Duo farklı video sinyallerinin eşzamanlı sergilenmesi için iki monitöre sahiptir. Örneğin, monitörün biri bir YUV 4:2:2 sinyal sergileyebilirken diğeri RGB 4:4:4 sinyal alır. Monitörün biri NTSC gösterirken, diğeri PAL gösterebilir. Çok sayıda değişik kombinasyonlar oluşturulabilir ve monitörlerin her birine tek bir SDI kablo bağlamak kadar kolaydır.

SmartScope Duo 4K; SmartView Duo ile aynı özelliklere sahip olmakla birlikte, gerçek zamanlı olarak video ve ses seviyelerini izlemek üzere waveform, vektörskop ve başka popüler skopların görüntülenmesi için de kullanılabilir. Buna ek olarak, Ultra HD 4K için tam desteğe sahip oluyorsunuz.

SmartView ve SmartScope monitörleri üzerindeki tüm SDI giriş bağlantıları, 2K video dahil SD, HD veya 3G-SDI sinyallerinin otomatik tespitini destekler. SmartView 4K ayrıca; 12G-SDI aracılığıyla ayrıca, 2160p60 gibi formatlar dahil, Ultra HD'yi de tespit eder. SmartScope Duo 4K; 6G-SDI aracılığıyla, Ultra HD 4K videonun otomatik tespit özelliğine sahiptir.

Tek bir bilgisayardan, birden fazla SmartView ve SmartScope üniteleri için ayarları uzaktan değiştirmek istediğinizde, bunları Ethernet aracılığıyla birbirine bağlayabilirsiniz. Böylece, ayarları her değiştirmek istediğinizde, bir bilgisayar ve USB kablosu ile her bir üniteye koşturmak zorunda kalmazsınız.

Kullanmaya başlamak için yapmanız gerekenler bu kadar. SmartView ve SmartScope ürünlerini bağlamak, Blackmagic SmartView kurulum yazılımında monitör ayarlarını yapılandırmak ve bir ağa bağlanmak hakkında daha ayrıntılı bilgi için, kılavuzu okumaya devam edin.



SmartView 4K



SmartView HD



SmartView Duo



SmartScope Duo 4K

Video Kaynaklarının Takılması

SmartView ve SmartScope monitörleri; switcher, kamera, video yakalama kartları, deck ve disk kaydediciler dahil, SDI ekipmanlara bağlanmaya yarayan standart BNC konektörler içerir.

Bir Görüntünün Elde Edilmesi

Videonuzu görüntülemek kolaydır! Yapmanız gereken tek şey, üniteyi çalıştırmak ve video kaynağını bir SDI girişine takmaktır. Çalıştırdıktan ve bağlandıktan sonra, videonuz hemen görüntülenecektir. SD, HD ve 2K sinyaller, SDI giriş ve döngü (loop through) çıkış bağlantıları tarafından otomatik olarak algılanır. SmartView 4K ve SmartScope Duo 4K ayrıca Ultra HD 4K'yı da algılar.

Ünite tarafından herhangi bir video sinyali alınmadığında, arka lamba söner ve bir sonraki geçerli sinyal alınıncaya kadar güçten tasarruf yapılır.

Monitörlerin Birbirine Seri Bağlanması

Her bir SmartView ve SmartScope monitörünün bağımsız bir SDI girişi ve loop through çıkışı bulunduğundan, aynı giriş sinyalini görüntülemeleri için, birden fazla monitörü birbirine zincirleme bağlayabilirsiniz:

1. üniteyi çalıştırın. SDI girişe bir video kaynağı bağlayın. Video anında görüntülenecektir.
2. üniteyi çalıştırın. 1. ünitenin loop çıkışından bir SDI kablosunu, 2. ünite üzerindeki bir SDI girişe bağlayın.

Birbirine bağlayabileceğiniz ünite sayısında bir sınır yoktur.

SmartScope Duo 4K monitörünü kullanarak dalga şekli (waveform) izleme yapıyorsanız, her iki ekranın aynı giriş sinyalini kullanmaları için 1. monitörün çıkışını 2. monitöre loop yapmanız gerekecektir.

Artık videonuzu görüntüleyebildiğiniz için, monitör ayarlarını değiştirebilir, veya Blackmagic SmartView 4K üzerine 3D LUT yüklemek için de kullanabileceğiniz, Blackmagic SmartView kurulum yazılımını kullanarak, SmartScope Duo 4K monitöründen skoplar seçebilirsiniz.



Bilgisayarınızın Takılması

Bilgisayarınızı USB aracılığıyla bağlayarak ve Blackmagic SmartView kurulum yazılımını yükleyerek, SmartView veya SmartScope monitör ayarlarını yapılandırın.

USB bağlantısı ayrıca, Blackmagic Design internet sitesinden indireceğiniz dahili yazılım güncellemelerini uygulamak için de kullanılabilir. Yazılım güncellemeleri; yeni özellikler, yeni donanım ile uyumluluk ve yeni formatlar için destek sağlayabilir. Blackmagic SmartView kurulum yazılımını hem macOS hem de Windows bilgisayarlarında çalıştır.

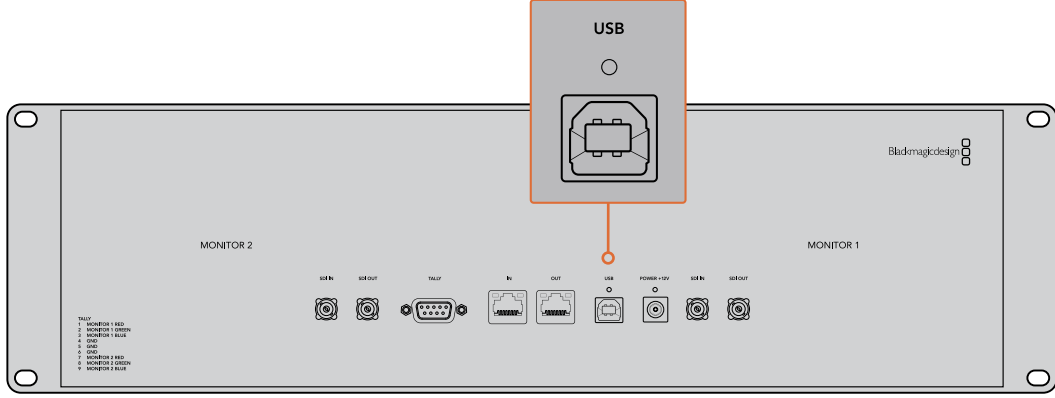

Blackmagic SmartView Setup Yazılımının Yüklenilmesi

Blackmagic SmartView kurulum yazılımı, macOS işletim sisteminin en son Sierra ve High Sierra sürümlerinde, ve en son servis paketleri yüklü Windows 8.1 ve 10'un 64-bit versiyonlarında çalışır. Arzu edilirse, Blackmagic SmartView kurulum yazılımı ağ üzerinde yüklü olan birden fazla bilgisayara yüklenebilir.

Yazılım yükleyici SmartView ile birlikte gelen SD kartı üzerindedir, ancak www.blackmagicdesign.com/tr/support adresine girmenizi ve en son sürüme sahip olduğunuzdan emin olmanızı öneriyoruz.

macOS sistemine yüklemek için:

Kutuda gelen SD kartını veya indirilen disk görüntüsünü açın ve SmartView yükleme ikonu üzerine çift tıklayın. Uygulamalar dosyasında; SmartView setup yazılımı, güncelleme yaparken daha önceki sürümlerin silinmesi için bir program kaldırıcı ve bu kılavuz ile başka SmartView bilgilerinin bulunduğu, bir belge dosyası içeren SmartView dosyası oluşturulacaktır.

Windows sistemine yüklemek için:

Windows sisteminde, kutuda gelen SD kartını veya indirilen zip dosyasını açın ve SmartView yükleyici üzerine çift tıklayın. Yazılımı yüklemek için ekran üzerindeki komutları takip edin.

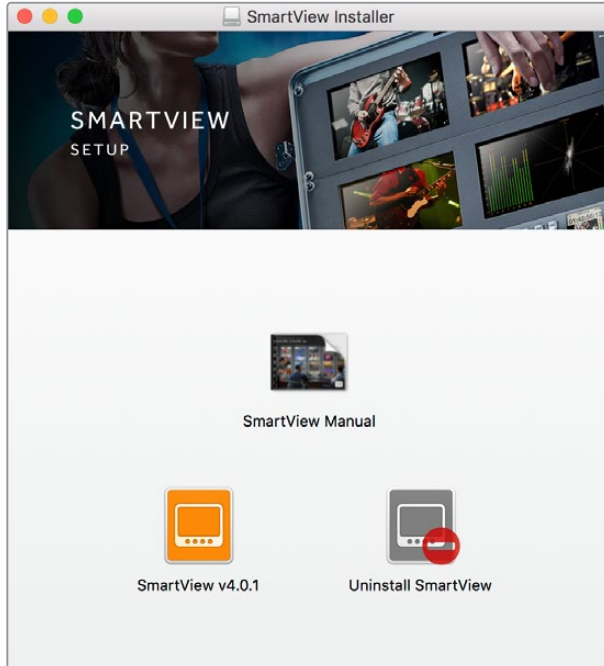

macOS sisteminde yüklemek için, kutuda gelen SD kartındaki veya yüklenenler dosyasındaki SmartView.dmg dosyasını başlatın, sonra SmartView yükleme ikonu üzerine çift tıklayın

Blackmagic SmartView Setup Yazılımının Kullanımı

Yazılımın Güncellenmesi

Blackmagic SmartView kurulum yazılımı yüklenip başlatıldığında, monitör adının altındaki ayarlar ikonunu tıklayın. SmartView veya SmartScope monitörünüzün dahili yazılımını güncellemeniz için bir komut istemi belirebilir. Bu güncellemeyi yapmak için:

- 1 USB veya Ethernet aracılığıyla SmartView veya SmartScope monitörünüzü bilgisayara bağlayın ve Blackmagic SmartView kurulum yazılımını başlatın.
- 2 Komut istemi belirince, 'update' (güncelle) üzerine tıklayın. Güncellemenin tamamlanması 5 dakika kadar sürebilir.
- 3 Güncellemenin bitiminde şöyle bir mesaj belirir: "SmartView güncellenmiştir."
- 4 'Close' (Kapat) üzerine tıklayın.

Eğer herhangi bir dahili yazılım güncellemesi gerekmiyorsa, Blackmagic SmartView kurulum yazılımı monitörünüzün ayarlar sayfasını açacaktır.

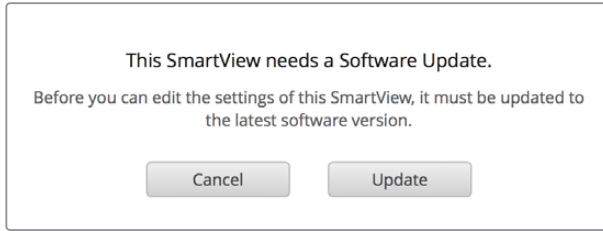

SmartView kurulum yazılımını başlatırken ve bağlı olan SmartView veya SmartScope monitörünüzün ayarlar ikonunu açarken, bir dahili yazılım güncellemesi gerekiyorsa bu mesaj belirir

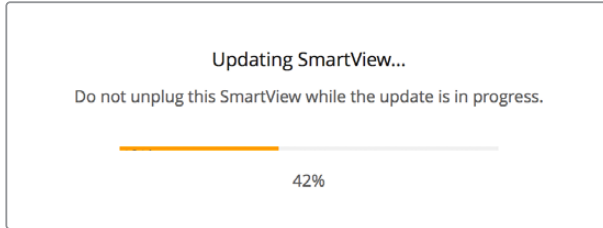

Güncellemenin tamamlanması 5 dakika kadar sürer

Monitör Ayarlarının Değiştirilmesi

Başlatıldığında, Blackmagic SmartView kurulum yazılımı derhal, USB veya Ethernet aracılığıyla bağlı bulunan SmartView ya da SmartScope ünitelerini arar ve bunları SmartView kurulum anasayfasında görüntüler. Açınıza bağlı bulunan birden fazla Blackmagic monitörü mevcutsa, ayarlamak istediğiniz monitörü seçmek için, anasayfanın her iki tarafındaki sol ve sağ ok ikonlarına tıklayın. Blackmagic monitörünüz bir USB ile bağlı ise, monitör adının yanında bir USB ikonu belirecektir.

Ayarları deęiřtirmek için, Ethernet ve USB yoluyla baęlı olan monitörünüzü seçin ve monitör adı altındaki ayarlar ikonuna tıklayın. Bu işlem, seçili olan monitörünüzün ayarlar sayfasını açacaktır. Yaptığınız ayarlardan memnun kaldığınızda, bu ayarları kaydetmek ve SmartView kurulum anasayfasına geri dönmek için 'save' (kaydet) butonuna tıklayın.

Blackmagic monitörleri için mevcut olan ayarlar ve bunları nasıl uygulayacağınız hakkında bilgi için bir sonraki bölüme bakın. Blackmagic SmartView kurulum yazılımını kullanarak aę ayarlarını nasıl yapılandıracağınız hakkında bilgi için, "adjusting network settings" (aę ayarlarının deęiřtirilmesi) bölümüne bakın.

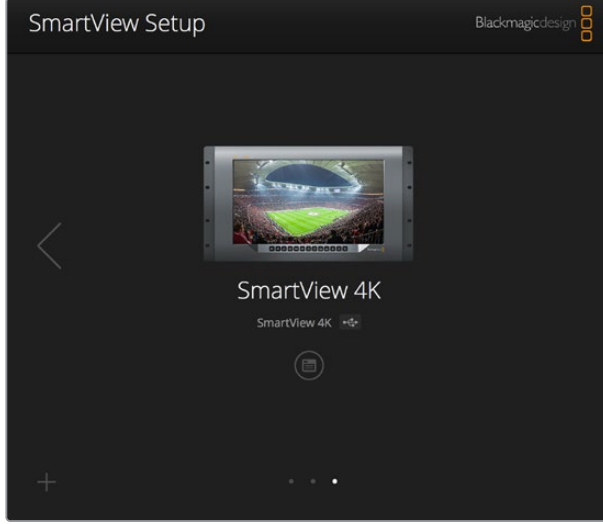

Blackmagic SmartView kurulum yazılımı, USB aracılığıyla veya bir aę üzerinden, yerel olarak baęlı bulunan SmartView ve SmartScope ünitelerini otomatik olarak arar. Monitörünüzün dahili yazılımını güncellerken, monitörünüzün USB veya Ethernet ile baęlı olduğundan emin olun. Monitörünüzün adının yanında bir USB ikonu belirecektir.

Monitör Ayarları

Her bir monitör için, ayarları ve ekranları deęiřtirmek için, bunların Ethernet veya USB yoluyla baęlı olması gerekmektedir. SmartView kurulum anasayfasındaki sol ve saę ok ikonlarını tıklayarak ayarlamak istediğiniz monitörü seçin, sonra monitör adının altındaki ayarlar ikonunu tıklayın. Seçili bulunan Blackmagic monitörünüz tarafından desteklenen özelliklere uygun olarak ayarlar sayfası otomatik olarak kişiselleřtirilir.

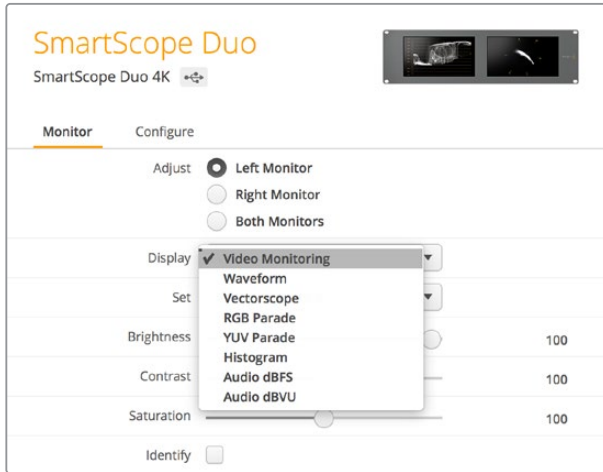

SmartScope ile ařaęı açılan 'display' (ekran) menüsünden skop veya video izleme modu arasında seçim yapabilirsiniz.

Ayarlama (Adjust)

Bir SmartScope veya SmartView Duo kullanırken, 'left monitor' (sol ekran), 'right monitor' (sağ ekran) veya her ikisini aynı anda ayarlamak için 'both monitors' (her iki ekran) modları arasında ayarlamak istediğiniz monitörü seçin. 'Both monitors' ayarı etkinleştirildiğinde, SmartView Duo ve SmartScope üzerindeki her iki monitöre parlaklık, kontrast ve doygunluk ayarlarında yapılan değişiklikler uygulanacaktır.

Ekran (Display)

Bir SmartScope monitör kullanırken, aşağı açılan 'display' (ekran) menüsü, aralarından seçim yapabileceğiniz skoplar sunar. Video görüntüsünü görmek isterseniz 'video monitoring' (video izleme) ayarını seçin.

Ayarları Kaydet (Set)

Bir SmartScope kullanırken; aşağı açılan 'set' (ayarları kaydet) menüsü, standart tanımlı video kullanırken video izleme ekranı için 4:3 veya 16:9 en boy oranını (aspect ratio) seçme imkanı sunuyor. Aşağı açılan 'Set' menüsü; vektörskop, ses dBFS ve ses dBVU dahil, seçili olan ekran için ek seçenekler sunar.

- **Video İzleme:** Video görüntüsünü 4:3 veya 16:9 en boy oranlarıyla izlemek için seçin. Geniş ekran anamorfik standart tanımlı video izlerken, 16:9 en boy oranını seçin. Geleneksel 4:3 standart tanımlı video izlerken, 4:3 en boy oranını seçin.
- **Vektörskop:** Girişinizin renk çubuğu test sinyallerine %100'mü yoksa %75'mi bağlı olduğunu seçin.
- **Ses dBFS:** Fazı izlemek için ses kanalı çiftini seçin.
- **Ses dBVU:** Fazı izlemek için ses kanalı çiftini seçin.

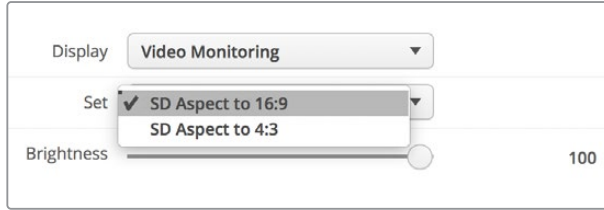

Anamorfik standart tanımlı video izlerken "SD Aspect to 16:9" olarak ayarlayın

Parlaklık, Kontrast, Doymunluk

Parlaklık, kontrast ve doymunluk ayarlarını uygulamak için bu kaydırıcıları kullanın. Kullanabileceğiniz ayarlar SmartView ile SmartScope modelleri arasında değişir.

Monitörün Belirlenmesi

'Identify' (Belirle) onay kutusu etkinleştirildiğinde, Blackmagic SmartView kurulum yazılımında seçilen herhangi bir monitör beyaz bir çerçeve sergileyecektir. Bir ağ aracılığıyla birden fazla SmartView ve SmartScope ünitesi bağlı ise, bu ayar seçili monitörü görsel olarak tanımlamayı kolaylaştırır.

Bu ayar 'both monitors' ayarıyla birlikte kullanıldığında, beyaz çerçeve her iki SmartView Duo veya SmartScope Duo 4K monitörleri üzerinde sergilenir.



Parlaklık, kontrast ve doygunluk ayarlarını uygulamak için kaydırıcıları (slider) sola ve sağa sürükleyin. Seçili monitörünüzü tanımlamak için 'Identify' ayarını kontrol edin.

Tally Kontrolünü Etkinleştir

Blackmagic SmartView 4K'da tally çerçevesini aktif hale getirmek için 'enable tally override' seçeneğini seçin. Bu özellik, Blackmagic URSA Mini Pro 4.6K ve Blackmagic URSA Broadcast ile uyumludur.

Kameranın SDI çıkışını, SmartView 4K'daki A veya B girişine bağlayın.

ATEM switcher'in program çıkışını, kameranın SDI girişine bağlayın.

ATEM switcher kamerayı program çıkışına geçirdiğinde, SmartView 4K'da kırmızı bir tally çerçeve görünür. Önizleme çıkışına geçildiğinde, tally çerçevesi yeşil renkte görünür.

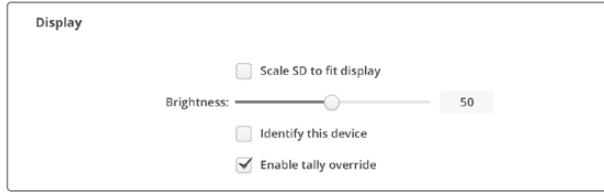

Blackmagic URSA Mini Pro veya URSA Broadcast kameraya bağlıyken SmartView 4K'da tally çerçevesini görüntülemek için, 'enable tally override' onay kutusunu tıklayın.

SmartView 4K'nın Kullanımı

Blackmagic SmartView 4K ile Tanışın

SmartView 4K; 2160p60 Ultra HD video'ya kadar SD, HD ve native izleme imkanı sunan, 6 RU ölçüde, Ultra HD 12G-SDI yayın monitörüdür. Parlak ekranı ve geniş izleme açısı ile SmartView 4K, doğru odak ve renk izleme imkanı için canlı ve net bir görüntü sağlar ve adeta her video formatını destekler.

Stüdyo ve stüdyo dışı yayın ortamları için tasarlanmış olan SmartView 4K monitörünün kullanımı inanılmaz derecede kolaydır. Yanlardan montajlı konnektörleri ve VESA desteği mevcuttur. Ünite, dar alanlara sığdırılabilir veya bir duvara ya da eklemli kol üzerine monte edilebilir. SmartView 4K, dahili kontrol panel kullanılarak ya da ön panele erişim sağlayamadığınız durumlarda, Ethernet aracılığıyla uzaktan çalıştırılabilir.

İki adet çoklu hız 12G-SDI girişi, SDI kaynakları arasında seçim yapmanıza olanak sağlarken, optik fiber SDI modül ilave ederek videonuzu optik fiber yoluyla bağlayabilmeniz için bir SMPTE uyumlu SFP modül soketi mevcuttur. Video sinyalini başka ekipmanlara yönlendirebilmeniz için bir 12G-SDI çıkış bulunur. Bununla birlikte ağ oluşturmak için iki Ethernet konnektör, uzaktan kontrol özelliği ve başka monitörlere seri bağlantı için loop çıkışı mevcuttur. Diğer konnektörler arasında canlı yapım için bir tally girişi ve dahili yazılım güncellemeleri için de bir USB port bulunur.

Hatta Blackmagic SmartView kurulum yazılımını kullanarak .cube uzantılı endüstri standardı 3D LUT'lar veya DaVinci Resolve ile üretilen LUT'lar yüklenebilir. 3D LUT'lar ile SmartView 4K monitörünüzü kameranıza bağlayabilir ve kliplerinizi son derecelendirme kalitesine en yakın kalitede izleyebilirsiniz. İki seviyeli focus peaking özelliği, çekimlerinizin kusursuz odaklanmasını mümkün kılıyor. AC ve DC güç kaynağına destek ile, SmartView 4K monitörünüzü şebeke prizine veya sette taşınabilirlik için harici bir bataryaya takma esnekliğine sahipsiniz.

SmartView 4K videonuzu SD, HD ve native 3840x2160 piksel çözünürlüğü ile Ultra HD'de görüntüleyebilmesi sebebiyle, portatif ve stüdyo yayın prodüksiyonu için ideal izleme çözümüdür.



NOT DC güç girişi ile harici güç bağlanıyorsa, harici güç çıkışınızın 12 voltta 24 watt temin etme kapasitesine sahip olduğundan emin olun.

Kontrol Panel Butonları

Kontrol paneli, bir sıra butona sahip olduğundan, SmartView 4K monitörünüz üzerindeki ayarları hızla değiştirebilirsiniz.

Input (Giriş)

Bu butona bastığınızda, SmartView 4K monitörünün iki adet 12G-SDI girişine bağlı olan video sinyalleri arasında dolaşım sağlanır. Bir girişte video bağlı bulunmuyorsa, SmartView 4K o giriş için siyah görüntüler. Girişler arasında geçiş yaparken, bağlı olan giriş formatınız hakkındaki bilgiler, monitörünüzün üst sol köşesinde anlık olarak sergilenir.

Disp

'Disp' butonu, SmartView 4K monitörünüzün LCD ekranının parlaklık ayarının değiştirilmesi için kullanılır. Yukarı ve aşağı ok butonlarını basarak parlaklığı ayarlayabilirsiniz. Bu ayarı kapatmak için 'disp' butonuna tekrar basın.

H/V Delay (Yatay/Dikey Gecikme)

'H/V delay' butonuna bastığınızda, SDI video sinyalinde yardımcı verinin gömülü olup olmadığını hızla doğrulayabilirsiniz. Örneğin, yatay yardımcı veriyi izlemek için H/V butonuna bir kez basın. Genellikle kapalı alt yazı gibi veriler için kullanılan dikey yardımcı veriyi izlemek için, H/V butonuna tekrar basın.

Blue Only (Yalnızca Mavi)

Bir dijital video sinyalinde gürültü mevcutsa, mavi kanalda belirgin bir şekilde görünür. Mavi kanalınızda gürültü olup olmadığını kolayca kontrol etmeniz için, 'blue only' (yalnızca mavi) butonuna basın. Bu işlem siyah ve beyaz bir görüntü olarak temsil edilen yalnızca mavi kanalını görüntüler. Bu siyah beyaz görüntü ayrıca, kamera odağını gözden geçirirken de yardımcı olması amacıyla kullanılabilir.

Zoom

Net bir kamera odağı elde etmenin bir yöntemi, 'zoom' butonunu kullanmaktır. Görüntüyü büyütmek için bir kez basın. Bunu yaptığınızda bir nesnenin odakta olup olmadığını açıkça görebilirsiniz. Normal izleme boyutuna geri dönmek için tekrar zoom'u tıklayın.

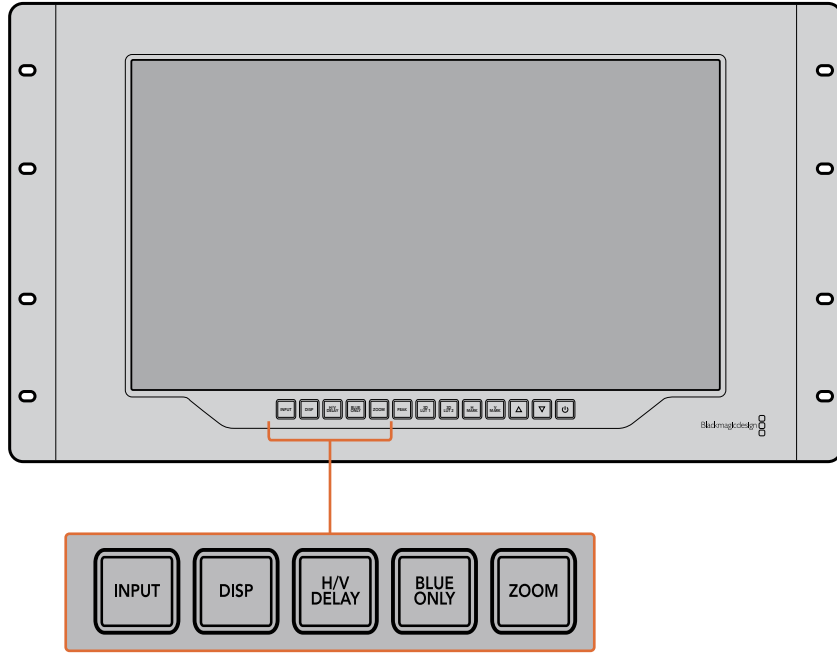

Peak (Pik)

Focus peaking özelliğini etkinleştirmek için 'peak' butonunu tıklayarak kameranın odak ayarı kolaylıkla kontrol edilebilir. Bu, görüntünüzdeki en keskin noktaların çevresinde parlak yeşil bir kenar çizgisi görüntüler. Peak butonuna tekrar basılmasıyla, aralarında seçim yapabileceğiniz iki adet peaking keskinliği seviyesi bulunmaktadır. Yeşil kenarları en keskin iken, kameranızın odakta olduğundan emin olabilirsiniz.

3D LUT 1 ve 3D LUT 2

LUT butonları, görüntünüzü Blackmagic DaVinci Resolve'de üretilmiş veya özel 3D LUT'ları veya endüstri standardı .cube LUT'ları kullanarak izlemenize imkan tanır. LUT'u etkinleştirmek için LUT butonuna bir kez basın. LUT'u etkisizleştirmek için tekrar basın. 3D LUT'ların SmartView 4K ile kullanılması hakkında daha fazla bilgi için, 'Blackmagic SmartView Setup kullanılarak 3D LUT'ların Yükleneceği' bölümüne bakın.

H Mark ve V Mark

'H Mark' ve 'V Mark' butonları kullanılarak, kare işaretleyicileri görüntülenebilir ve değiştirilebilir. Kare işaretleyicileri, görüntülerinizi oluşturmanıza veya önemli bilgi ya da grafiklerin, ekranın güvenli alanında kalmalarına yardımcı olur. Farklı televizyonlar video sinyallerinin kenarlarını biraz fazla veya biraz eksik görüntülediklerinden, güvenli alanı görebilmek açısından yararlıdır. Güvenli alan, görüntüyü izlemek için hangi televizyon veya monitör kullanılıyor olursa olsun, ekranın mutlaka görüntülenecek alanıdır.

Yatay ve dikey kare işaretleyicilerini görüntülemek için, H Mark ve V Mark butonlarına sırasıyla basınız. İşaretleyicilere değişiklik yapmak için, kılavuzların her birini vurgulamak üzere ilgili

butonlara tekrar basın. Bu işlem, yukarı ve aşağı ok butonlarının kullanılmasıyla işaretleyicilerin konumlarını değiştirmenize olanak sağlıyor. Her bir butona tekrar basılması, yeni konumlarınızı doğrular. Tekrar bastığınızda, işaretleyiciler etkisizleştirilir.

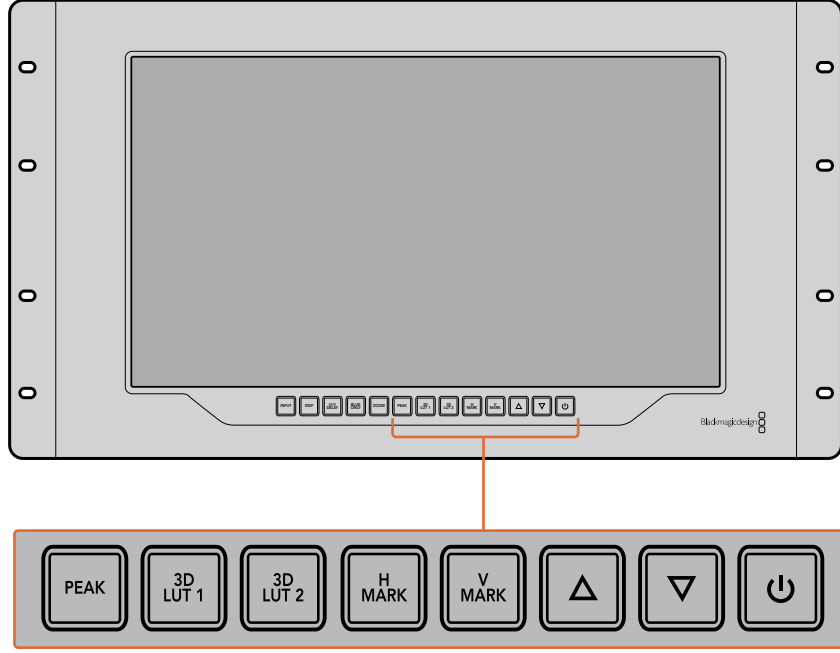

Yukarı ve Aşağı Ok Butonları

Bir ayarı değiştirirken yukarı ve aşağı ok butonlarını kullanın. Örneğin, ekran parlaklığını ayarlarken veya kare işaretleyicilerin konumlarını değiştirirken.

Güç

SmartView 4K'yı çalıştırmak için, güç butonuna bir kez basın. Kapatmak için tekrar basın.

Blackmagic SmartView Setup Kullanılarak 3D LUT'ların Yüklenmesi

SmartView 4K, 3D LUT'lar kullanılarak videonuzun izlenmesini sağlar. Bu özellik, profesyonel kalibrasyon LUT'ları kullanarak, SmartView 4K'nızı kalibre etmeniz veya videonuzu en son renk derecesine mümkün olduğunca yakın bir görüntüyle izlemeniz için seçenek sunar. 3D LUT'ları, farklı görünümleri denemek için de kullanabilirsiniz. LUT'lar, SmartView 4K'ya Blackmagic SmartView Setup kullanılarak yüklenir. SmartView 4K, .cube dosya uzantılı, endüstri standardı LUT dosyalarını desteklediğinden, Blackmagic DaVinci Resolve ile üretilen özel LUT'lar dahi yüklenebilir. LUT'ların oluşturulması hakkında daha fazla bilgi için DaVinci Resolve kullanım kılavuzuna bakınız.

3D LUT 1 içine bir 3D LUT yüklemek için:

- 1 Blackmagic SmartView Setup'ı başlatın.
- 2 'Load LUT 1' yükleme butonuna basın. Yükleme istediğiniz LUT dosyasının yerini belirtmenizi isteyen bir pencere açılacaktır. Dilediğiniz .cube LUT dosyasını seçin, sonra 'open' (aç) butonuna basın.
- 3 Biraz önce yüklemiş olduğunuz LUT'u izlemek için SmartView 4K kontrol panelindeki 3D LUT 1 butonuna basın. LUT'u kapatmak için butona tekrar basın.

3D LUT 2'ye bir LUT dosyası yüklemek için aynı işlemi tekrarlayın.

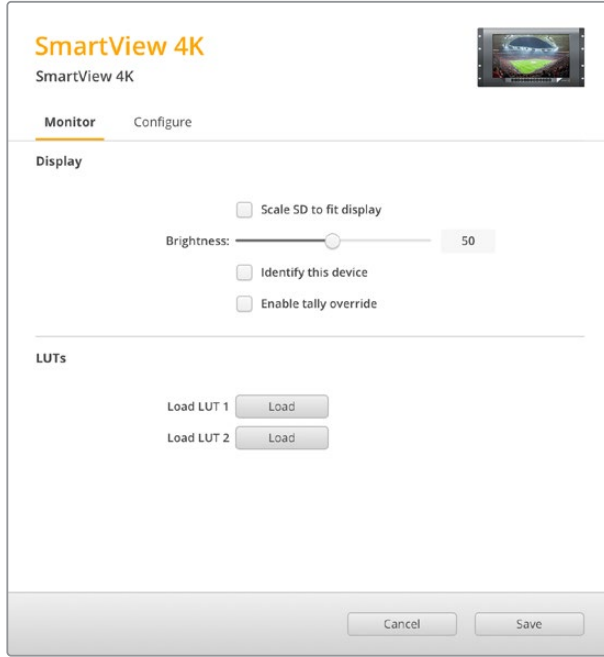

SmartView 4K üzerine 3D LUT yüklemek için Blackmagic SmartView Setup'ı kullanın.

SmartScope Duo 4K Kullanımı

Blackmagic SmartScope Nedir?

Daha önceleri, yayın kalitesinde televizyon ve post prodüksiyon skopları, inanılmaz derecede pahalı ve küçük bir ekranda sadece tek bir skopu gösterebilen özel çözümlerdi. Bazı skoplar kötü bir görünüme sahiptir ve müşterilerinizin de görmelerini istemeyeceğiniz niteliktedir.

SmartScope Duo 4K ile ayrıca waveform (dalga şekli) monitörlerine sahip oluyorsunuz. Bunlar, çift monitörlerinizde video sinyalinizin herhangi bir açısını gerçek zamanlı olarak izlemenizi sağlar. Blackmagic SmartView Setup yazılımında giriş sinyaline yaptığınız herhangi bir değişiklik anında SmartScope Duo 4K'da görülebiliyor. Buna ek olarak, her bir giriş sinyali monitörlerden herhangi birine SDI loop çıkışı yoluyla iletilebilir. Böylece, soldaki monitöre giden sinyalin skoplarını görüntülemek için, sağdaki monitörü kullanabilirsiniz.

SmartScope Duo 4K tarafından sergilenen göstergeler, Blackmagic SmartView kurulum yazılımında seçilir. Aşağı açılan 'display' (ekran) menüsünden skoplarınızı seçin.

Aşağıda ve devamındaki sayfalarda açıklanan bilgiler, her bir göstergenin, size ne şekilde yardımcı olabileceği hakkında daha kapsamlı bir bilgiye sahip olabilmemiz açısından, gösterge ekranlarının nasıl kullanıldığını açıklamaktadır.

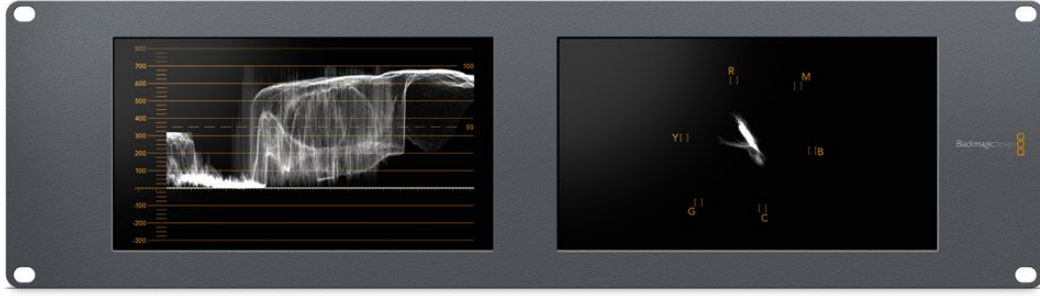

Blackmagic SmartView kurulum yazılımı kullanılarak her bir monitörde farklı bir göstergenin görüntülenmesi için, Blackmagic SmartScope Duo 4K'nın ayarlanması kolaydır.

Video İzleme Ekranı

Video İzleme ekranı, SmartScope'ye giden video sinyalini görerek, sonuçtan emin olmanızı sağlayan bir monitördür.

Eğer giriş sinyaliniz SD formatındaysa, aşağı açılan 'set' (ayarları kaydet) menüsünden 4:3 pillarbox veya 16:9'da görüntülemesi seçenekleri arasında bir seçim yapabilirsiniz. LCD ekranının parlaklık, kontrast veya doygunluk ayarlarına yapılan herhangi bir değişiklik, bu ekran penceresinde anında görünebilir. Aklınızda bulunsun ki, bu ayarların değiştirilmesi video sinyalini değil, sadece monitörü etkiler. Dolayısıyla, yapacağınız herhangi bir doygunluk veya parlaklık değişikliği göstergeleri etkilemeyecektir.

Monitörlerden birini 'video izleme' monitörü olarak ayarlayıp, bir diğeri de skop ekranı olarak ayarlamamız işinizi kolaylaştırabilir. Bunu yapmak için, 'monitör 1' SDI loop çıkışını 'monitör 2' SDI girişine bağlamak için kısa bir kablo kullanın.

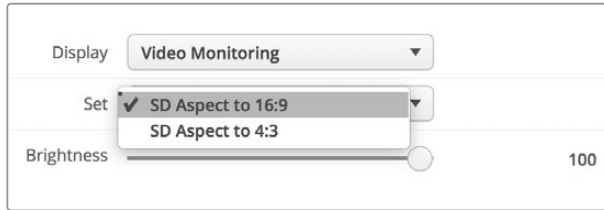

Blackmagic SmartView setup'daki 'set' menü seçeneklerinden seçerek, SD videoyu 4:3 pillar box veya 16:9 geniş ekran modunda izleyebilirsiniz. Anamorfik standart tanımlı video izlerken "SD Aspect to 16:9" olarak ayarlayın.

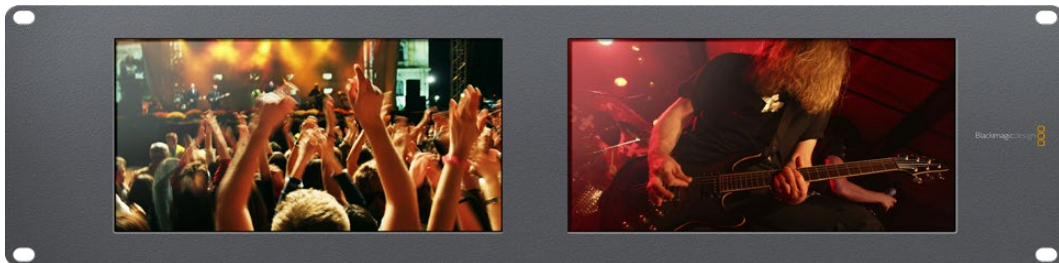

Video izleme ekranı ayarı, video sinyalini bir televizyon ekranı veya monitörde, görüntünün normalde görüneceği haliyle gösteriyor.

Waveform (Dalga Şekli) Ekranı

Waveform ekranı, geleneksel parlaklık waveform monitörleri gibi dijital olarak kodlanmış bir waveform sunar, bu da video sinyalinin luma (parlaklık) seviyesinin izlenmesi ve düzeltilmesi için kullanılır.

Geleneksel parlaklık waveform monitörleri, yalnızca composite analog standart tanımlı videoyu destekliyorlardı. Ancak, SmartScope Duo 4K'nın waveform ekran penceresi Ultra HD ve HD'nin yanında SD formatında da çalışıyor. Böylelikle, yüksek çözünürlüklü dijital video formatlarını izlerken bile, luma seviyelerini düzeltmenin tutarlı ve kolay bir yöntemine sahip oluyorsunuz.

Blackmagic SmartView setup yazılımındaki aşağı açılan display (ekran) menüsünden, 'waveform' (dalga şekli) opsiyonunu seçin. İlegal (yayına uygun olmayan) luma değerlerine karşı önlem almak için, waveform göstergesindeki siyahlarınızın %0'ın altına düşmediğinden ve beyazların ise %100'ün üzerine çıkmadığından emin olun.

Waveform monitörü, görüntünün grafiksel bir temsildir ve kare içinde bulunan luma değerlerine ilişkin aynı konumda olan luma değerlerini gösterir. Örneğin, gökyüzünün bir kısmı aşırı pozlanmışsa, waveform ekranında da, karede belirttiği aynı yatay konumda görünecektir.

Kamera çekimlerinize bağlı olarak, waveform göstergesi farklı görünecektir. Yüksek kontrast içeren bir video izlediğinizde, orta grilerdeki değerleri göremeyebilirsiniz. Aşağıdaki resim, solda koyu bir alan ve karenin ortasından sağa doğru daha parlak değerlere sahip, eşit bir şekilde pozlanmış bir görüntünün dalga şekli değerlerini göstermektedir.

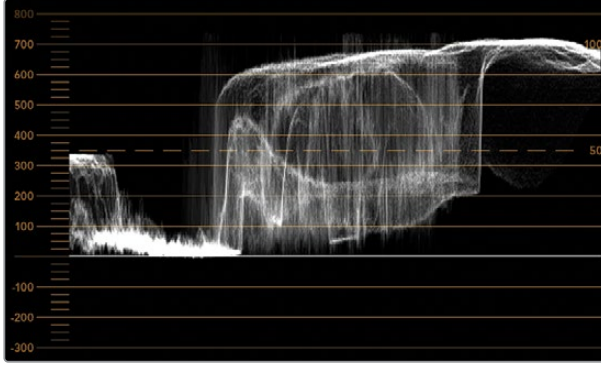

Parlaklık değerlerini gösteren waveform göstergesi

Adjust	<input checked="" type="radio"/> Left Monitor
	<input type="radio"/> Right Monitor
	<input type="radio"/> Both Monitors
Display	Waveform ▼
Set	No Options ▼

Blackmagic SmartView setup 'display' (ekran) ayarlarından 'waveform' opsiyonunu seçerek, video sinyalinizdeki parlaklık değerlerini izleyebilirsiniz.

Vektörskop Ekranı

Vektörskop ekranı bir video sinyalindeki renkleri göstermeye yarayan bir vektör görüntüleme modu kullanır. Tesisinizde kullanılan renk çubuğu test sinyallerinin standardına bağlı olarak, Blackmagic SmartView setup yazılımındaki aşağı açılan 'set' menüsünden %100 veya %75 opsiyonunu seçin.

Bazı insanlar vektörskopun illegal (yayına uygun olmayan) seviyelerin kontrolü için kullanıldığını düşünürler ancak, bu doğru değildir. Tüm illegal renklerin kontrolü için Parade RGB ekranı kullanılmalıdır. Vektörskopu, illegal seviyeleri kontrol etmek için kullanamıyor olmanızın sebebi, hem chroma hem de parlaklık değerlerine gereksinim olmasıdır. Örneğin, videodaki beyaz veya siyah noktalara yakın renkler, orta grilerde kullanılabilen çok daha keskin renklerdeki kadar doygun olamazlar. Vektörskop ekranı, parlaklık değerlerini değil, sadece renkleri gösterdiğinden, sadece illegal renkleri kontrol üzere kullanılamaz.

Vektörskop ekranı, chroma seviyelerinin düzeltilmesini gerektiren daha eski, analog video kasetlerindeki renk seviyelerini kontrol etmek için en iyi araçtır. Video kasetinin renk çubuğu bölümünü oynatın ve sonra, gratiküldeki (enlem boylam çizgisi) kare kutular kapsamında videonun renklerini ayarlamak üzer, chroma ve hue (renk tonu) ayarlarını düzeltin.

Vektörskop ekranı renk derecelendirme işlemleri için de mükemmeldir çünkü, videonuzun beyaz ayarının doğru olup olmadığını veya bir renk tonu olup olmadığını kolayca kontrol edebilirsiniz. Videonuzda bir renk tonu varsa, vektörskop ekranı merkezden sapar ve merkezinde iki nokta görünebilir. Normalde video sinyalindeki blanking (karartma) işlemi vektörskopun merkezinde bir nokta oluşturur. Bunun nedeni, videodaki kararmanın içinde hiç bir renk barındırmayan bir siyah olmasıdır. Blanking özelliği, renk bilgisi olmayan siyah video bölümlerini tespit etmekte faydalı bir referans noktası sağlıyor.

Videonuzda bir renk tonu mevcutsa, siyahların bulunduğu renkten ve merkezden sapmalarını gözlemleyebilirsiniz. Sapma oranı videonuzdaki renk tonunun miktarını belirler. Bu sapma videonuzun hem beyaz hem de siyah detaylarında görülebilir. Bu özellik, renk tonunun giderilmesinde ve doğru beyaz ayarın yapılmasında, vektörskopu değerli bir araç kılar.

Vektörskop ekranı, siyahlara veya beyazlara yanlışlıkla istenilmeyen renk tonları katmadan, videonuzdaki renklerin sınırlarını zorlamanızı sağlar. Renk dengesi, hem RGB parade hem de vektörskop görüntüsünde izlenebilirken, renk dengesindeki olası sorunlar genelde vektörskop görüntüsünde daha kolay görülebilir.

Özellikle yüz bölgesi olmak üzere, cilt tonu içeren çekimlerin renk düzeltmelerini yaparken, sıcak renk doygunluğunun değerini, vektörskop üzerinde saat 10'u gösteren bir açıda, eşit bir çizgide tutmanız gerekecektir. Bu "fleshtone line" (cilt rengi çizgisi) olarak adlandırılır ve cilt yüzeyinin altındaki kanın rengine bağlı olarak belirlenir. Fleshtone çizgisi her türlü cilt pigmentasyonu için uygulanabilir ve videonuzdaki kişilerin cilt tonlarının doğal görünmesini sağlamanın en iyi yoludur.

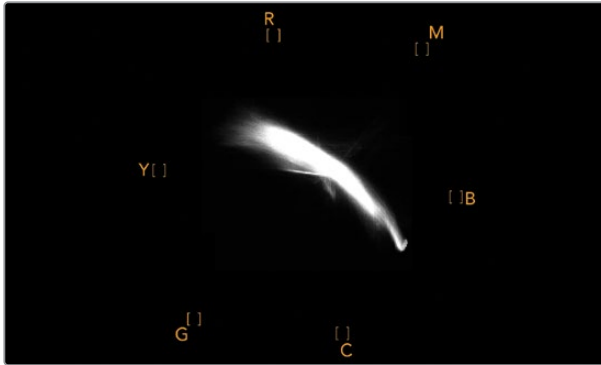

Saat 10'u gösteren bir konuma doğru eğilimli 'fleshtone çizgisini' gösteren bir vektörskop ekranı

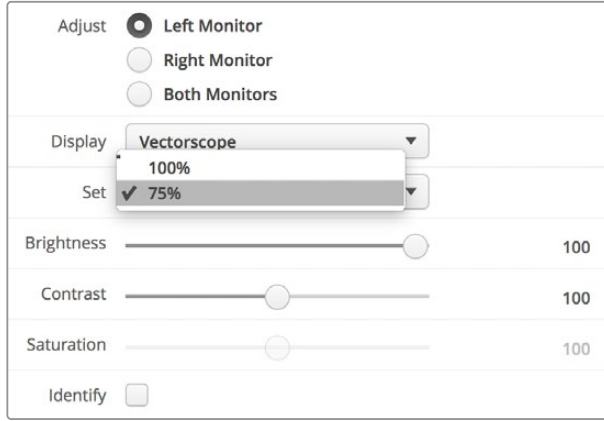

Vektörskopunuzu %100 veya %75 renk çubuğu test sinyallerine ayarlayın

Parade Ekranı

RGB ve YUV parade ekranları renk düzeltme, illegal (yayına uygun olmayan) renkleri kontrol etmek ve seviyeleri kontrol etmek için harikadır.

Renk düzeltme işlemi yaparken, Blackmagic SmartView kurulum yazılımındaki aşağı açılan 'display' (ekran) menüsünden RGB parade opsiyonunu seçin. RGB parade penceresi, münferit kırmızı, yeşil ve mavi renk kanallarının tam boyunu görüntüler. Renk kanallarının her birinin izlenmesi, renk düzeltme sürecini kolaylaştırıyor. Ayrıca, video sinyalindeki siyahların, orta tonların ve beyazların renk dengesini izlemek de kolaydır. RGB parade; kırmızı, yeşil ve mavi kanalları arasındaki ortak nitelikleri tespit etmenizi sağlayarak, arzu edilmeyen renk tonlarını gidermeyi ve renk dengesini ayarlamayı kolaylaştırır.

Renk düzeltme işlemleri yaparken, video seviyelerinin full olduğundan fakat clipping'e maruz kalmadığından emin olmanız önemlidir. Video seviyesini artırmak isterseniz, RGB sınırının üstüne çıkmadığından emin olunuz. Aksi takdirde, illegal seviyeler oluşacaktır. Bazı ekipmanlar illegal %100 seviyelere ulaşmanızı engellerken, başka ekipmanlarda böyle bir önlem yoktur. SmartScope Duo 4K illegal seviyeleri, oluştukları an görmenizi sağlar.

İllegal video seviyeleri siyah ve beyaz seviyelerinde de oluşabilir. Bazı renk düzeltme sistemlerinde, siyah seviyeleri %0 olan siyah noktasının altına indirilebilmektedir. Videonuzda illegal siyah seviyeler tespit ederseniz, bunları gidermek için biraz "lift" veya gain ilave etmeniz yeterlidir ancak, video sinyalinin tamamının lift işlemine maruz kalmadığından ve beyazlarda illegal renkler üretmediğinden emin olmak üzere %100 gratikül seviyesini kontrol edin.

YUV seviyelerini kontrol etmek için, aşağı açılan 'display' menüsünden YUV parade ibaresini seçin. Bu görüntü penceresi faydalıdır çünkü luma (parlaklık) değerleri chroma (renk) değerlerinden ayrıştırılmıştır. Bu da, televizyon yayını için olan video sinyalleri formatıdır. Soldaki waveform luma bilgilerini ve ikinci ile üçüncü waveform'lar da chroma bilgilerini gösteriyor. YUV parade penceresi, bir video sinyalinin chroma değerlerini bir renk çubuğu test düzenine (pattern) kalibre etmek için faydalıdır. Böylelikle, renkler doğru bir nitelikte temsil edilir ve yayınlanan sinyal televizyon ekranlarında görüntülenebilir.

Renk düzeltme işlemi, illegal seviyeler oluşturmadan en iyi görünüme sahip görüntüler elde etmeye yarayan sonsuz bir ayarlama sürecidir.

Renk Düzeltme Terminolojisi

Blacks (Siyahlar) – Video sinyalindeki siyah seviyeleri

Mids (Orta Tonlar)– Video sinyalindeki orta-gri seviyeleri

Whites (Beyazlar) – Video sinyalindeki beyaz seviyeleri

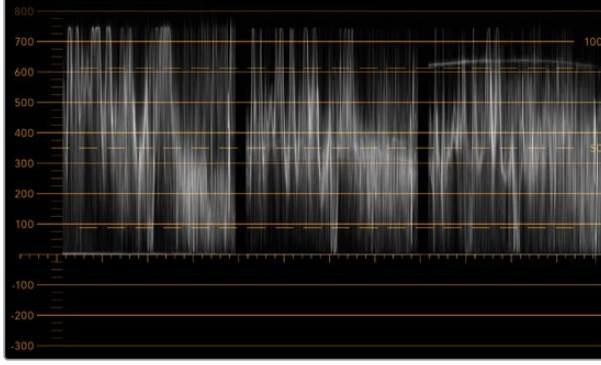

RGB parade görüntüleme

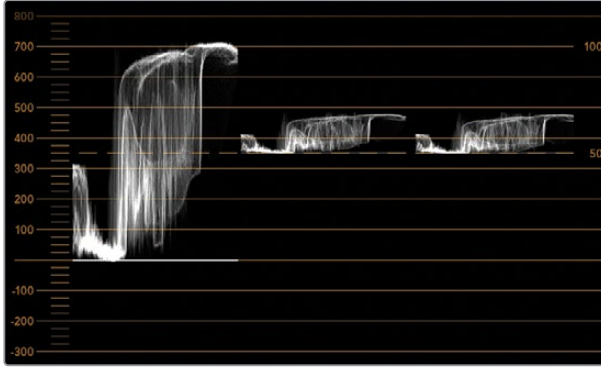

YUV parade görüntüleme

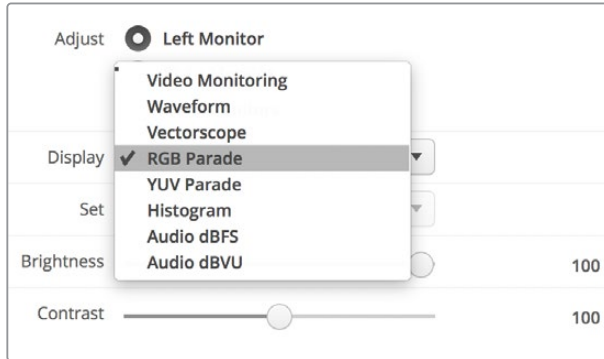

Blackmagic SmartView setup'taki aşağı açılan 'display' (ekran) menüsünden RGB parade ile YUV parade opsiyonları arasından seçin.

Histogram Ekranı

Grafik tasarımcıların ve kamera operatörlerinin en aşına oldukları ekran histogram penceresidir. Histogram, beyazdan siyaha doğru olan bilgilerin dağılımını gösterir ve görüntülerdeki ayrıntıların, videonun beyazlarında veya siyahlarında clipping'e maruz kalmaya ne kadar yakın olduğunu izlemenizi sağlar. Histogram ekranı ayrıca, videodaki gamma değişikliklerinin etkilerini görmeyi sağlar.

Ekranın solu siyah videoyu gösterirken, sağ tarafı da beyazları göstermektedir. Videonun tamamı genelde histogram ekranının %0 ila %100 zaman aralıkları arasında bulunmalıdır. Videonuz %0'ın altına veya %100'ün üzerine geçtiği an clipping'e maruz kalır. Çekim sonrası kontrollü bir ortamda renk düzeltme işlemleri yapmak istediğiniz durumlarda, siyah ve beyazlardaki ayrıntıların mutlaka muhafaza edilmesi gerektiğinden, çekim yaparken videodaki görüntülerin clipping'e maruz kalması çok kötü bir sonuç doğurabilir. Çekim yaparken videoyu siyah klibin üzerinde ve beyaz klibin altında tutun. Böylelikle, beyazların ve siyahların mat ve ayrıntıdan yoksun görünmesini engelleyerek daha sonradan renkleri düzeltmek için daha fazla özgürlüğe sahip olursunuz.

Renk düzeltme yaparken, videonuza clipping işlemi uygulamak isteyebilirsiniz. Bu durumda, histogram ekranı clipping'in video üzerindeki etkisini ve clipping işlemine ne kadar maruz kaldığını gösterecektir. Clipping'e daha az maruz kalmış, daha fazla ayrıntı içeren benzer bir görünüm oluşturmak için gamma dahi kullanabilirsiniz.

Histogram ekranını illegal (yayına uygun olmayan) seviyeleri kontrol etmek için pek kullanamazsınız ancak, illegal siyahları ve beyazları görmek için kullanabilirsiniz. Histogram ekranı renkleri göstermediğinden, videonuz illegal renkler içermesine rağmen histogram legal (yayına uygun olan) seviyeleri gösteriyor gibi görünebilir. Bu durumda da RGB parade ekranı, illegal seviyeleri video sinyalinin hem renk hem de parlaklık öğelerinde yansıttığından, bunları kontrol etmenin en iyi yoludur.

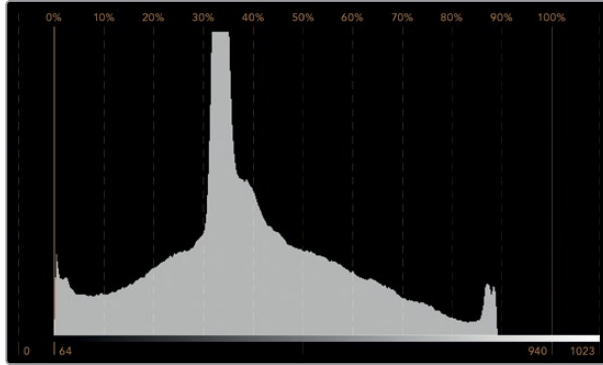

Histogram ekran ayarı, beyazlar ile siyahların dağılımını gösterir

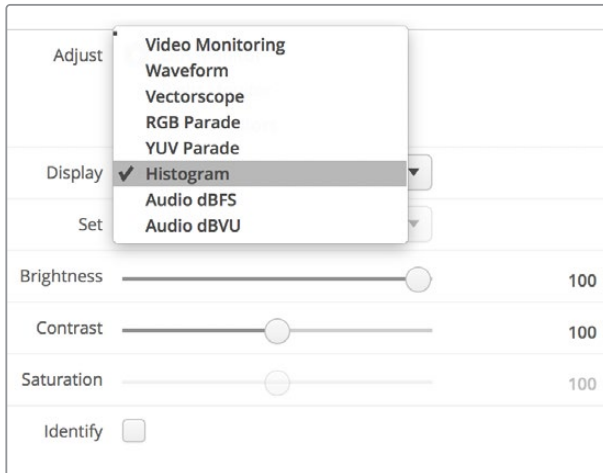

Blackmagic SmartView kurulum yazılımındaki aşağı açılan 'display' (ekran) menüsünden histogram opsiyonunu seçin.

Ses Göstergeleri Ekranı

Ses göstergeleri ekranı, SDI video sinyalinin gömülü (embedded) ses kayıtlarındaki ses seviyelerini gösterir. 16 kanala kadar gömülü (embedded) ses önce ayrıştırılır (de-embedded) sonra da, dBVU veya dBFS formatında görüntülenir.

VU sayacı ortalama sinyal seviyesini gösterir, kullanımı kolaydır ve daha eski ekipmanlarda yaygındır. VU metre, SMPTE tarafından önerilen referans değeri olan ve -20 dBFS'ye ayarlı, 1 kHz test ton sinyaline kalibre edilir.

dBFS esasında genel dijital ses sinyalinin bir ölçüğüdür ve modern dijital ekipmanlarda yaygındır.

Sağ taraftaki ses skopu iki ses kanalını izleyebiliyor. Bu kanalları aşağı açılan 'set' menüsünden seçebilirsiniz. Örneğin, kanal 1 & 2, kanal 3 & 4, vb. Ses skopu, sesi X-Y görüntüleme olarak sunar. Böylece, ses dengesindeki sorunları, faz dışı ses koşullarını ve bir ses kanalının mono mu yoksa stereo mu olduğunu görebilirsiniz. Mono ses tek bir dikey "in phase" (fazda) satır olarak belirecektir. Eğer çizgi yataysa, ses "faz dışı" demektir ve başka ekipmanlara iletildiğinde sıfırlanabilir (yani ses kaybı oluşabilir). Ses fazı, büyük tesislerde, kabloların yanlış bağlanması sonucu karşılaşılan en yaygın sorunlardan bir tanesidir.

Stereo sinyallerini izlerken, sol ve sağ ses kanalları arasındaki farkı temsil etmek üzere, sağ taraftaki ses skopun çizgisi dışa doğru yayılır. Ses kanalında ne kadar fazla stereo sesi bulunuyorsa, çizgi bir o kadar dairesel görünecektir. Eğer ses minimal seviyede stereo içerik bulunduruyorsa, bu durumda skop dikey eksen çevresinde daha yoğun görünecektir.

Diyalog sesi genelde dikey bir çizgi olarak görünür. Oysa fazla miktarda stereo içeriğe sahip olan müzik, skopun dışa doğru yayılmasına sebep olur. Bunun sebebi mono sesin L+R olması ve dikey eksen üzerinde görüntülenmesidir. Halbuki, stereo içerik L-R'dir ve stereo farkı yansıtmak üzere yatay eksen üzerinde görüntülenir.

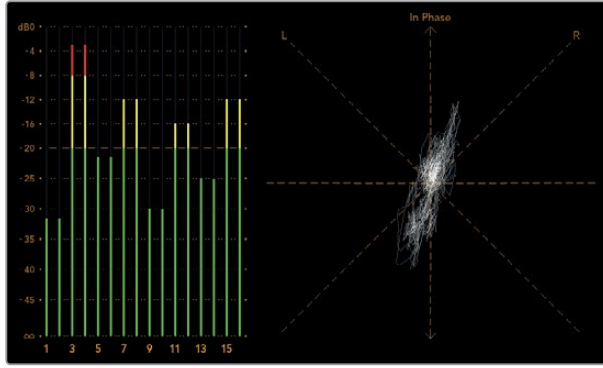

Pik seviyeleri ve ses dengesini gösteren ses gösterge ekranı

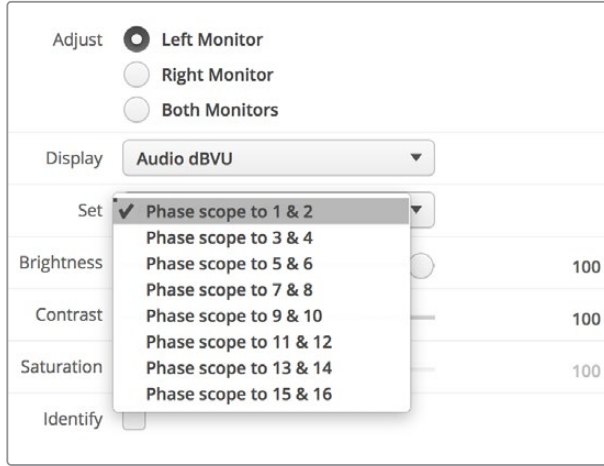

Aşağı açılan "Set" menüsünü kullanarak, izlemek istediğiniz ses çiftini seçiniz.

Bir Ağa Bağlanırken

Bir SmartView veya SmartScope monitörünü bir ağa bağlayarak, birden fazla ünitenin ayarlarını uzaktan düzeltebilirsiniz.

SmartView ve SmartScope monitörleri herhangi bir yapılandırma gerektirmeden videoyu görüntüledikleri için, yapılması gereken herhangi bir ağ ayarı, etkinleştirilmeden önce yapılandırılmalıdır. Ağ yapılandırması yalnızca, bir bilgisayara doğrudan USB bağlantısıyla uygulanabilir.

Doğrudan Ethernet Bağlantısı

Bir monitörün uzaktan yapılandırılması, bilgisayarınıza yapılan direkt Ethernet bağlantısıyla uygulanabilir. Bu yapılandırmada herhangi bir ağ anahtarına gerek yoktur. Bu da, hızla kurulum ve düzenleme yapmanız gerektiği durumlarda harikadır. Her bir ünitenin üzerindeki aktif loop-through Ethernet çıkış portu kullanılarak, ek üniteler birbirine seri şekilde bağlanabilir. Zincirdeki tüm ünitelere güç beslemesi yapılmalıdır.

Mevcut stüdyo ağınızda bulunan IP adreslerini kullanmadan çok sayıda üniteyi bağlamak isterseniz veya mevcut bir ağınız yoksa, onları doğrudan bilgisayarınızdaki Ethernet portuna bağlayın. Bu yöntem ayrıca SmartView ve SmartScope ünitelerini Ethernet yoluyla bağlamanın hızlı bir yoludur çünkü, bir ağ anahtarına herhangi bir kablo uzatmanız gerekmemektedir.

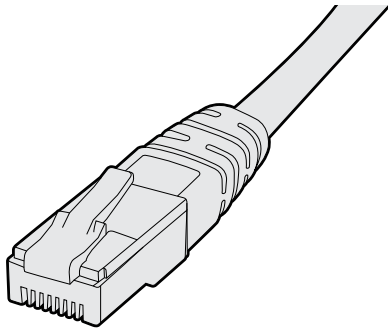

Ethernet Konnektörü

Ethernet Ağ Anahtarı

Stüdyonuzun ağına birkaç tane ünite bağlamak istiyorsanız, ağ anahtarına sadece bir SmartView veya SmartScope ünitesi bağlamanız yeterlidir. Diğerleri ise, her bir ünitenin üzerindeki aktif loop-through Ethernet çıkış portu kullanılarak birbirine seri şekilde bağlanabilirler. Böylelikle, anahtar (switch) üzerinde yalnızca tek bir port kullanılmış olur. Böylece, bir ağ anahtarına birden çok sayıda kablo uzatmanız gerekmeyecektir. Seri bağlantı (daisy-chaining) özelliğinin çalışması için tüm ünitelere güç sağlanmalıdır.

Bir ağ anahtarına bağlanmak, ağ üzerinde bulunan herhangi bir bilgisayarın, herhangi bir ünitenin ayarlarını değiştirmesine olanak sağlıyor. Ağınız, kablosuz erişim noktası içeriyorsa, bir WiFi bağlantısı yoluyla herhangi bir Mac veya Windows dizüstü bilgisayarıyla da ayarlar değiştirilebilir.

Bir IP bazlı yerel alan ağına SmartView veya SmartScope ünitenizi bağlamak için, aşağıdaki basamakları uygulamanız gerekecektir.

- 1 Ünitenizle gelen güç kaynağını güvenli bir şekilde bağlayıp çalıştırın.
- 2 Üniteyi standart bir RJ45 Ethernet kablosu ile bir ağ anahtarına veya doğrudan bilgisayara bağlayın.

Doğrudan Ethernet Bağlantı Şeması

Bir ağ anahtarına gereksinim olmadan, bir bilgisayarın Ethernet portunu üniteye direkt bağlayabilirsiniz. Bir ağ anahtarına birden çok kablo uzatmanıza gereksinim kalmaması için, ek üniteler birbirine seri şekilde bağlanabilir. Tüm ünitelere güç sağlanmalıdır.

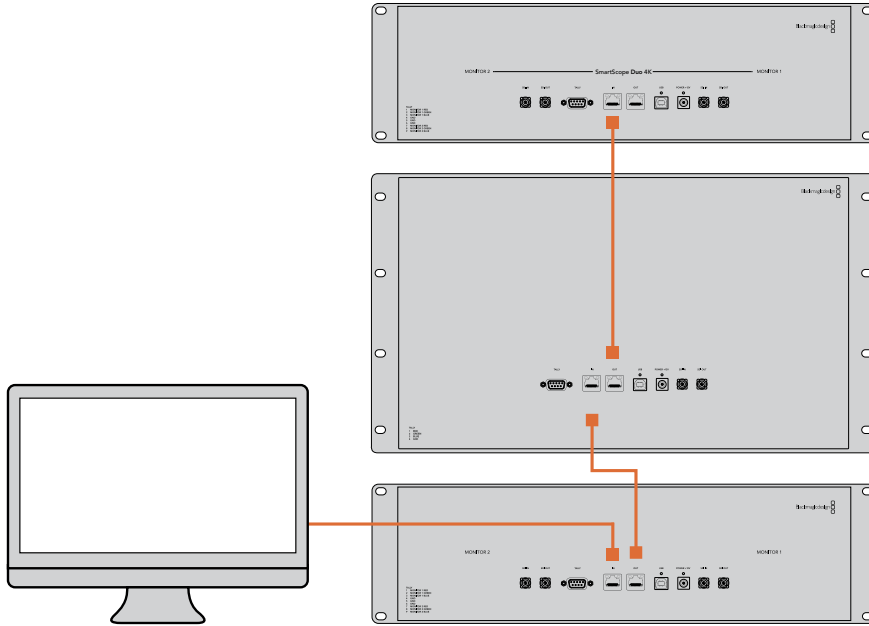

Ethernet Ağ Anahtarı Bağlantı Şeması

Stüdyonuzun mevcut ağına birçok ünite bağlamak istediğiniz takdirde, ağ anahtarına ünitelerin yalnızca bir tanesini bağlamanız gerekecektir. Bir ağ anahtarına birden çok kablo uzatmanıza gereksinim kalmaması için, diğerleri birbirine seri şekilde bağlanabilir. Tüm ünitelere güç sağlanmalıdır.

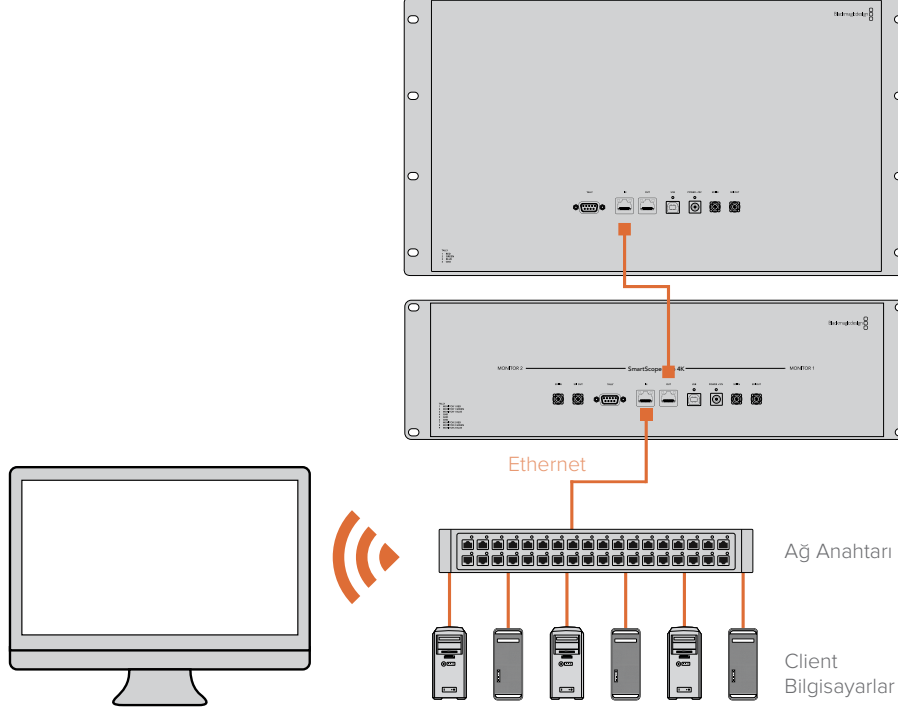

Ağ Ayarlarının Değiştirilmesi

Ağ Ayarları

Cihaz Adı

Her bir SmartView veya SmartScope ünitesinin ağ üzerinde kolayca ayırt edilebilmesi için, monitörünüzün adını değiştirmenizde yarar vardır. Örneğin, “Saha Kameraları 1 & 2”, “Multi-View Çıkış”, “4K sinyaller” vb.

Monitörünüzün adını değiştirmek için, monitörünüzün Ethernet veya USB ile bağlı olduğundan emin olun. Blackmagic SmartView kurulum yazılımını başlatın ve monitör adının altındaki ayarlar ikonunu tıklayın. Ayarlar sayfasında, ‘network’ ibaresini tıklayın ve ‘details’ (bilgiler) bölümünde bulunan monitör adını değiştirin. Yazılım, geçersiz bir ad tespit ederse, siz yeni adı tuşlarken, ad yanında bir uyarı ikonu belirecektir. Belirtilen ad geçersiz ise, yeşil bir işaret belirecektir. Ad değişikliğini teyit etmek için bilgisayar klavyesi üzerindeki ‘return’ sekmesine basın.

Ağ Ayarları

Blackmagic SmartView kurulum yazılımındaki ağ ayarları bölümüne değişiklikler yapmak için, Blackmagic monitörünüzün bilgisayara bir USB ile bağlı olması gerekmektedir. Ağ ayarları Ethernet aracılığıyla değiştirilemez.

Varsayılan ayarları olarak, SmartView ve SmartScope üniteleri ağından otomatik olarak bir IP adresi atamak üzere DHCP protokolünü kullanır.

Bir DHCP sunucusunun olmadığı durumlarda, doğrudan bağlı olan ünitelere DHCP adresleri atamak için, macOS'in "internet paylaşımı" (internet sharing) özelliğini veya Windows 8.1 ya da Windows 10 sistemlerinin "internet bağlantı paylaşımı" (internet connection sharing) (ICS) özelliklerini etkinleştirmenizde yarar vardır. Böylelikle, her bir üniteye manuel olarak bir sabit IP adresi atama gereksinimi ortadan kalkar. Bilgisayarınızın bir internet bağlantısı olmasa dahi, DHCP adreslerini atamak için bu özelliği kullanabilirsiniz. macOS ile Windows 8.1 ve 10 sistemlerinin Yardım dokümantasyonlarında, internet paylaşımı hakkında ayrıntılı bilgi bulabilirsiniz.

Sisteminizin yapılandırmasında DHCP protokolü kullanılamıyorsa, adresi "sabit IP" kullanarak yapılandırmayı tercih edin. Ağınızda bir IP çakışmasına sebebiyet vermemek için, lütfen sistem yöneticinizden yedek bir IP adresi talep ediniz. Her bir SmartView ve SmartScope ünitesine, kendine özgü bir IP adresi ve ortak bir altağ maskesi belirlemeniz gerekecektir. Ünitelerinizi Internet yönlendiricisi gibi bir ağ geçidine bağlamayı düşündüğünüz durumlar hariç, "geçit" (gateway) alanındaki varsayılan değeri değiştirmenize gerek yoktur.

Ağ üzerinde herhangi bir SmartView veya SmartScope monitörü bulunamamışsa, ünitelere DHCP yoluyla bir IP adresi atanmamış olabilir. Bu durumda, her bir üniteyi uygun ağ ayarlarıyla manuel olarak yapılandırmanız gerekecektir.

- 1 USB kullanarak, Blackmagic SmartView veya SmartScope monitörünüzü bilgisayarınıza bağlayın ve Blackmagic SmartView kurulum yazılımını başlatın.
- 2 Bağlı olan monitörünüz SmartView Setup ana sayfasında otomatik olarak görüntülenecektir ve adının yanında bir USB ikonu belirecektir.
- 3 Monitörünüzün ağ ayarlarını düzeltin.
- 4 DHCP ile bir IP adresi atanmamış olan diğer üniteler için de bu basamakları tekrarlayın.

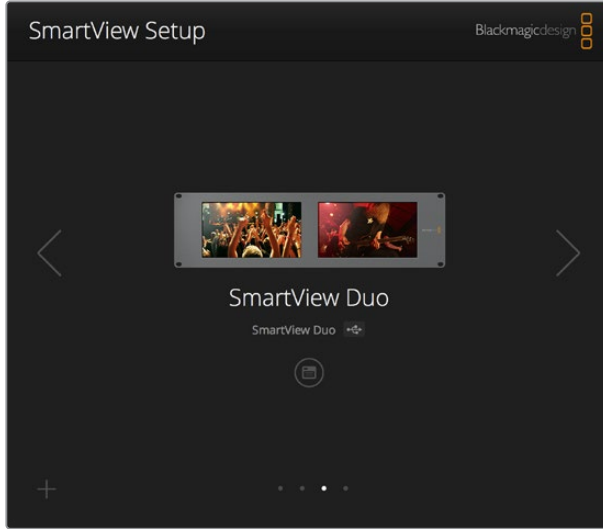

Monitörünüzün adının yanındaki USB ikonu, monitörün bilgisayarınıza USB ile bağlı olduğunu gösterir. Ağ ayarlarını düzeltebilmeniz için, Blackmagic monitörünüzün USB ile bağlı olması gerekmektedir.

Monitor	Configure
Details	
Name:	SmartView Duo
Software Version:	4.0.1
Network Settings	
IP setting:	<input type="radio"/> DHCP <input checked="" type="radio"/> Static IP
IP Address:	192.168.10.42 <input type="checkbox"/>
Subnet Mask:	255.255.255.0
Gateway:	192.168.10.1
<input type="button" value="Cancel"/> <input type="button" value="Save"/>	

Ağ ayarları DHCP veya bir sabit IP adresi kullanmak üzere ayarlanabilir ve yalnızca USB yoluyla değiştirilebilir

Bir Blackmagic Monitörünün İlave Edilmesi

Bir SmartView veya SmartScope Duo 4K ünitesinin IP adresini biliyor fakat bu adres Blackmagic SmartView kurulum yazılımında otomatik olarak belirmemişse, monitörü manuel olarak ilave edebilirsiniz. Bunu yapmak için:

- 1 Blackmagic monitörünüzün Ethernet yoluyla bağlı olduğundan emin olun. 'Add a Blackmagic monitor' (Bir Blackmagic monitörü ilave et) penceresini açmak için, sol alt köşedeki 'plus' (artı) ikonunu tıklayın.
- 2 Monitörün IP adresini tuşlayın ve 'add' (ilave et) üzerine tıklayın.
- 3 Yazılım, ünitenin varlığını doğrulayacaktır ve SmartView kurulum yazılımı ana sayfasında kayıtlı olan Blackmagic monitörlerine ekleyecektir. Yeni ilave ettiğiniz monitörünüzü görmek için sağ okunu tıklayınız.

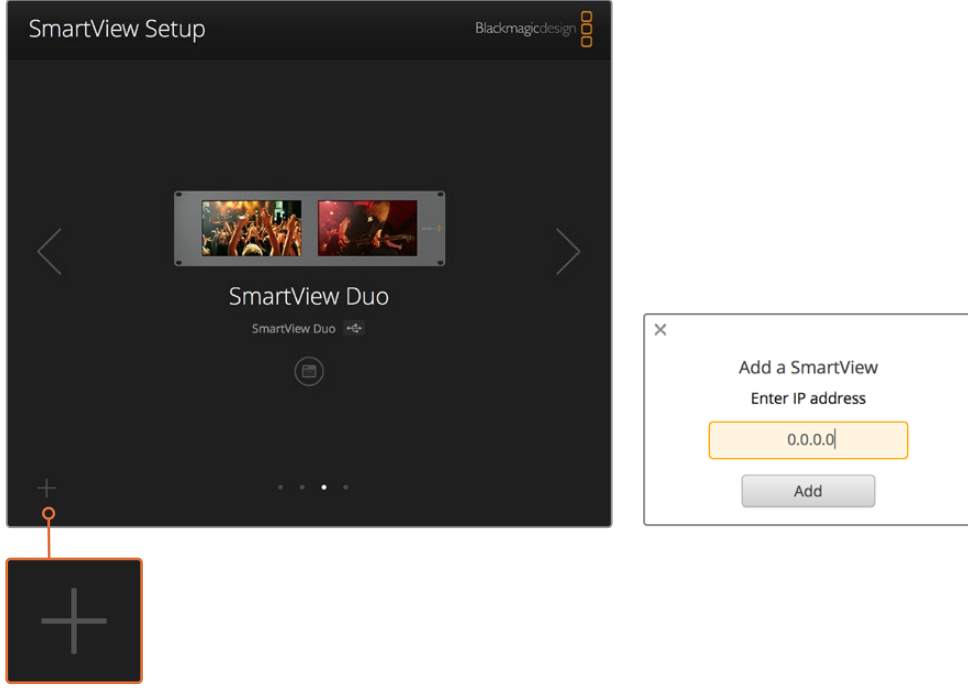

Bağlı olan monitörler listesine bir SmartView veya SmartScope monitörünü manuel olarak ilave etmek için, 'artı' ikonunu tıklayarak monitörün IP adresini girebilirsiniz.

Tally Özelliğinin Kullanılması

Tally Port Pim Bağlantıları

SmartView veya SmartScope ünitelerinin tally portunu bağlamanıza gerek yoktur ve tally özelliğini kullanmayı düşünmüyorsanız bu bölümü atlayabilirsiniz.

Her bir SmartView ve SmartScope ekranı, canlı yayında olma durumu, ön izleme ve kayıt özellikleri gibi, bir video sinyalinin durumunu belirtmek üzere kullanılacak üzere kullanılabilir ve kırmızı, yeşil veya mavi renklere sahip, bağımsız tally çerçeveleri içerir.

9-pin D-sub tally portu, switcher ve otomasyon sistemlerinden gelen kontak kapatma sinyallerini kabul eder. Switcher veya otomasyon sisteminizle kullanılmak üzere, tally portu bağlantısı hakkında bilgi için, ekteki tally pin bağlantıları şemasına bakınız.

9-pin D port bağlantı açıklaması ünitenin arkasında basılıdır. Bu açıklama, bağımsız monitörlerin her birinde kırmızı, yeşil veya mavi tally çerçeveleri görüntülemeye yarayan kontak kapatma konumlarını gösterir.

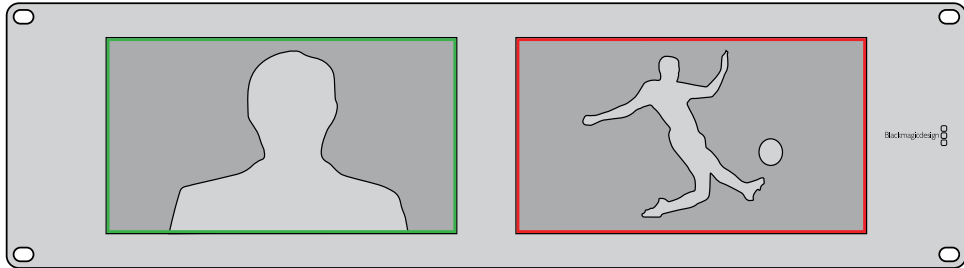

Yeşil ve kırmızı tally çerçeveleri gösteren SmartView Duo

SmartView Duo ve SmartScope Duo 4K
Tally Pin Bağlantıları

Pin	Fonksiyon
1	Monitör 1 Kırmızı
2	Monitör 1 Yeşil
3	Monitör 1 Mavi
4	Topraklama (Ground)
5	Topraklama (Ground)
6	Topraklama (Ground)
7	Monitör 2 Kırmızı
8	Monitör 2 Yeşil
9	Monitör 2 Mavi

SmartView Tally-Port

SmartView HD ve SmartView 4K
Tally Pin Bağlantıları

Pin	Fonksiyon
1	Kırmızı
2	Yeşil
3	Mavi
4	Topraklama (Ground)

İzleme Açısının Optimize Edilmesi

SmartView Duo, SmartView HD veya SmartScope monitörleri bir ekipman rack'inde yükseğe monte edilecekse, en iyi izleme açısını sağlamak üzere, LCD'leri ters çevirmenizde yarar vardır. LCD'ler tarafından çevrilme işlemi algılandığında, ekrandaki görüntüler otomatik olarak doğru yöne dönecektir. Arka montaj düzeninden koruyucu çerçeveyi çıkartmak ve tekrar takmak için, bir O2 büyüklüğünde pozidriv tornavida gerekecektir. Bu basit bir işlemdir ve arka montaj düzeninin açılmasını gerektirmemektedir.

Aşağıdaki uygulama, Blackmagic Design logosunu koruyucu çerçeve üzerinde doğru yönde tutarak üniteyi nasıl tersine çevirebileceğinizi açıklıyor. O2 boy numaralı pozidriv tornavida gerektirir.

- 1 Koruyucu çerçevenin üst, alt, sol ve sağ yüzlerindeki vidaları çıkartın. SmartView Duo ve SmartScope Duo 4K üniteleri üzerinde 10 adet vida bulunur ve SmartView HD üzerinde de 18 vida bulunur.
- 2 Resimde gösterildiği gibi, koruyucu çerçeveyi arka montaj düzeninden dışa doğru çekin.
- 3 Arka montaj düzenini tersine çevirin.
- 4 Tersine çevrilmiş arka montaj düzenindeki koruyucu çerçeveyi geri yerleştirin.
- 5 Kasanın vidalarını yerine takın.

SmartView veya SmartScope üniteniz artık yüksek bir rack'e kurulmaya hazırdır. Bir rack'e civatalandıktan sonra, SmartView ünitesi, yanlış kullanılabilecek veya gevşeyebilecek harici düğmelere sahip olmadığından ve ayar gerektirmediğinden, çarpma anında dahi en iyi izleme açısını görüntülemeye devam edecektir.



Ünitenizi yüksek bir rack'e civatalamadan önce, en uygun izleme açısını kontrol etmek amacıyla, üniteyi ters çevirerek bir deneme yapmanızda yarar vardır.

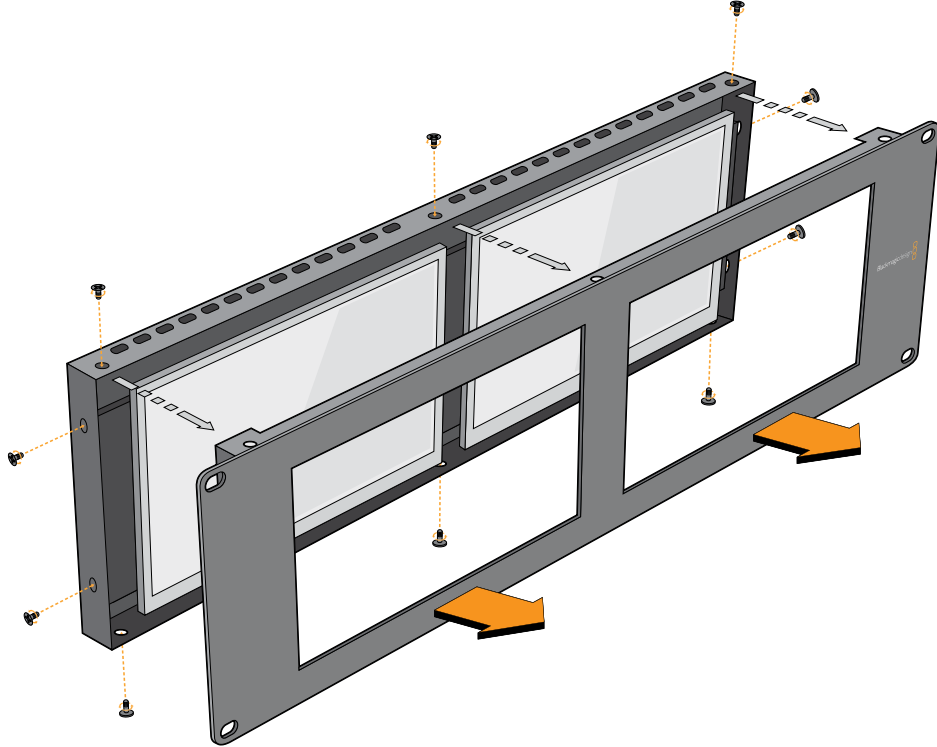

Koruyucu çerçeveyi arka montaj düzeninden dışa doğru kaldırmak için vidaların hepsini çıkartın.

Yazılım Geliştirici Bilgileri

Blackmagic Design Donanımları Kullanılarak Özel Yazılımların Geliştirilmesi

Blackmagic SmartView Ethernet Protocol, yazılım geliştiricilerinin kendi geliştirdikleri özel yazılımlarla Blackmagic SmartView ve Blackmagic SmartScope ünitelerini uzaktan kontrol etmelerini mümkün kılar. Blackmagic SmartView Ethernet Protocol bir metin bazlı durum ve kontrol protokolüdür.

Ücretsiz SmartView Ethernet Protocol'ün İndirilmesi

Blackmagic SmartView Ethernet Protocol ücretsizdir. Bu SmartView & SmartScope kılavuzuna dahil edilmiştir ve <http://www.blackmagicdesign.com/support/> adresinden indirilebilir.

Blackmagic Design Yazılım Geliştiriciler Listesine Dahil Olmak

Blackmagic Yazılım Geliştiricileri e-posta listesi, Blackmagic Design tarafından kullanılan teknolojilere ilişkin teknik sorular için tasarlanmıştır. Örneğin, QuickTime, Core Media, DirectShow, codecs, APIs, SDKs, vs. Ücretsiz olan bu liste, geliştiricilerin başka geliştiricilerle fikirlerini ve sorunlarını paylaşabileceği bir forumdur. Sunulan sorulara herhangi bir abone yanıt verebilir ve uygun olduğu durumlarda, Blackmagic Design mühendisleri de yanıt verebilirler. E-posta listesine abone olabileceğiniz link: <http://lists.blackmagicdesign.com/mailman/listinfo/bmd-developer>

Bazı durumlarda, internet alan adınızdan kurumunuzun video yazılımı geliştirdiği bariz şekilde anlaşılıyorsa, geliştirmekte olduğunuz yazılım hakkında kısa bir tanım talep edebiliriz. Bu talebimizi lütfen yanlış anlamayınız çünkü, amacımız abonelik listemizi istenmeyen e-posta ve virüslerden korumaktır. Aynı zamanda, kullanıcıların yazılım geliştirmekle alakası olmayan sorular yönelmelerini ve işçi bulma kurumlarının veya satıcıların, liste vasıtasıyla ürün reklamları yapmalarını önlemeyi amaçlıyoruz. Bu liste, sadece yazılım geliştiricileri içindir.

Blackmagic Design Yazılım Geliştiricilerine Yardım Hizmetiyle İrtibat

Geliştiricilere ilişkin veya listeye bağlı sorularınız olduğunda da, bizimle developer@blackmagicdesign.com adresinden irtibata geçebilirsiniz.



Blackmagic 2K Formatı – Genel Tanıtım

Blackmagic Design ürünleri, geleneksel HD-SDI videonun veri hızını ikiye katlayan 3G-SDI video teknolojisini destekler. Sinema filmi iş akışlarını kolaylaştırmak amaçlı olarak, 3G-SDI teknoloji sayesinde 2K film desteğini de ilave etmenin faydalı olacağını düşündük. Blackmagic Design kurgu sistemlerinin dünya çapındaki popülaritesi sayesinde, artık binlerce insan, sinema film iş akışlarından yararlanabilir.

Bu bilgiler, ürün geliştiricilerinin native 2K SDI ekipman geliştirmeleri için bilmeleri gereken her şeyi içerir. Kuşkusuz ki, Blackmagic ürünlerinin hepsi güncellenebilmektedir. Bu nedenle, televizyon endüstrisi alternatif bir SDI-bazlı film standardını benimsese bile, biz o standart için de destek ekleyebilmekteyiz.

Kare Yapısı

- Saniyede 23.98, 24 veya 25 kare hızlarında, Progressive Segmented Frame (PsF) olarak aktarılmaktadır.
- Aktif video 2048 piksel genişliğinde ve 1556 satır derinliğindedir.
- Kare başına toplam satır sayısı : 1650
- Satır başına düşen aktif sözcük sayısı 1535. Her kelime, dört adet veri akışının her biri için 10-bit bir örnekten oluşmaktadır. Örneğin, toplam 40 bit olmak üzere. Blackmagic 2K Format - Data Stream Format başlıklı şemaya bakınız.
- Toplam aktif satır sayısı: 1556
- Her satırdaki toplam sözcük sayısı : 23.98/24Hz için 1875 ve 25Hz için 1800.
- Kare başına alan sayısı: her biri 2, 825 satır
- 16-793 nolu (1. alan) ve 841-1618 nolu (2. alan) satırlarda bulunan aktif satır sayısı.

Aktarma Yapısı

- SMPTE 372M Dual Link eşleştirmeyi ve SMPTE 372M'yi tek bir 3 Gb/sn link'e eşleştirmeye yarayan SMPTE 425M-B desteğini baz alır.
- Zamanlama referans sinyalleri, satır numarası ve satır CRC ekleme işlemi yukarıdaki gibidir.
- Aktif video esnasında, 10-bit Kırmızı, Yeşil ve Mavi veri; aşağıdaki sekansta iletilir.
- Opsiyonel olan yardımcı veriler sanal arayüzün her ikisine de eklenir.
- Mevcut durumda, sadece ses verisi dahil edilmiştir: HD ses ekleme (SMPTE S299M) standardına uygun olarak ses veri paketleri ikinci veri akışında ve ses kontrol paketleri ise birinci veri akışında aktarılır.
 - Data stream 1: Green_1, Green_2, Green_3, Green_5...Green_2047
 - Data stream 2: Blue_1, Blue_2, Green_4, Blue_5...Green_2048.
 - Data stream 3: Red_1, Blue_3, Blue_4, Red_5...Blue_2048.
 - Data stream 4: Red_2, Red_3, Red_4, Red_6...Red_2048.

Blackmagic 2K Format – Vertical Timing Reference (Dikey Zamanlama Referansı)

Bu grafik, Zamanlama Referans Sinyali (Timing Reference Signal) kodları için; satır numarası ve Alan, Dikey ve Yatay bölüm bilgileri ile dikey zamanlama detaylarını gösterir.

		Field 1 (1. alan)					Aktif					
F	1	0	0	0	0	0	0	0	0	0	0	0
V	1	1	1	1	1	1	0	0	0	0	1	1
LINE # (SATIR NUMARASI)	1650	1	2	...	14	15	16	...	792	793	...	825

		Field 2 (2. alan)					Aktif					
F	0	1	1	1	1	1	1	1	1	1	1	1
V	1	1	1	1	1	1	0	0	0	0	1	1
LINE # (SATIR NUMARASI)	825	826	827	...	839	840	841	...	1617	1618	...	1650

Blackmagic 2K Format – Data Stream Format

Bu grafik, yatay çizginin opsiyonel yardımcı veri bölümünün çevresindeki veri akışı formatlarını gösterir. Aklınızda bulunsun ki, aktif piksellerin her biri üç örneklilik yer kaplar.

Word# 25 PsF	Word# 23.98/24 PsF	Data Stream 4	Data Stream 3	Data Stream 2	Data Stream 1
1795	1870	R2042	R2041	B2041	G2041
1796	1871	R2043	B2043	B2042	G2042
1797	1872	R2044	B2044	G2044	G2043
1798	1873	R2046	R2045	B2045	G2045
1799	1874	R2047	B2047	B2046	G2046
1800	1875	R2048	B2048	G2048	G2047
1	1	EAV(3FFh)	EAV(3FFh)	EAV(3FFh)	EAV(3FFh)
2	2	EAV(000h)	EAV(000h)	EAV(000h)	EAV(000h)
3	3	EAV(000h)	EAV(000h)	EAV(000h)	EAV(000h)
4	4	EAV(XYZh)	EAV(XYZh)	EAV(XYZh)	EAV(XYZh)
5	5	LN0	LN0	LN0	LN0
6	6	LN1	LN1	LN1	LN1
7	7	CRC0	CRC0	CRC0	CRC0
8	8	CRC1	CRC1	CRC1	CRC1
9	9	200	040	ANC/Audio Data	ANC/Audio Data
...		
260	335	200	040		
261	336	SAV(3FFh)	SAV(3FFh)	SAV(3FFh)	SAV(3FFh)
262	337	SAV(000h)	SAV(000h)	SAV(000h)	SAV(000h)
263	338	SAV(000h)	SAV(000h)	SAV(000h)	SAV(000h)
264	339	SAV(XYZh)	SAV(XYZh)	SAV(XYZh)	SAV(XYZh)
265	340	R2	R1	B1	G1
266	341	R3	B3	B2	G2
267	342	R4	B4	G4	G3
268	343	R6	R5	B5	G5

Blackmagic SmartView Ethernet Protocol v1.3

Özet

Blackmagic SmartView Ethernet Protocol, bir metin bazlı durum ve kontrol protokolüdür. Yapısal olarak Videohub protokolüne çok benzemektedir ve bir SmartView ya da SmartScope cihazı üzerindeki TCP port 9992'ye bağlanarak bu protokole erişim sağlanır.

Bağlantı kurulduğunda, SmartView veya SmartScope cihazı, cihazın eksiksiz bir dökümünü gönderir. İlk dökümden sonra, durum değişiklikleri eşzamanlı olmadan gönderilir.

Cihaz, bilgileri bloklar halinde iletir ve bu blokların tanımlayıcı bir başlığı, devamında da iki nokta üst üste bulunur. Bir blok birden fazla satırdan oluşabilir ve boş bir satır ile biter.

Gelecekteki protokol değişikliklerine karşı dayanıklı olabilmesi açısından, kullanıcılar izleyen boş satıra kadar, tanımadıkları blokları dikkate almamalıdır. Tanınan bloklar kapsamında, kullanıcılar tanımadıkları satırları dikkate almamalıdır.



Blackmagic SmartView Ethernet Protocol'ün 1.3 sürümü SmartView 1.3 yazılımıyla piyasaya sunulmuştur.

Protokol Preamble (Başlama Eki)

SmartView Server (sunucusu) tarafından gönderilen ilk blok, her zaman için protokol başlama ekidir.

```
PROTOCOL PREAMBLE:↵  
Version: 1.3 ↵  
↵
```

Sürüm (version) alanı protokol sürümünü belirtir. Protocol uyumlu bir şekilde değiştirildiğinde, minor sürüm numarası güncellenecektir. Uyumlu olmayan değişiklikler yapıldığında, asıl sürüm numarası güncellenecektir.

Cihaz Bilgileri

Bir sonraki blok, bağlı olan SmartView veya SmartScope cihazı hakkında genel bilgi içerir.

```
SMARTVIEW DEVICE:↵  
Model: SmartView Duo↵  
Hostname: stagefront.studio.example.com↵  
Name: StageFront↵  
Monitors: 2↵  
Inverted: false↵  
↵
```

Bu örnek, iki adet LCD'si bulunan bir SmartView Duo cihazının çıktısını gösteriyor. INVERTED uyarısı, LCD izleme açısının optimize edilmesi amacıyla, cihazın ters çevrilmiş bir şekilde montajlanıp montajlanmadığını belirtir.

Ağ Yapılandırması

Bir sonraki blok TCP/IP ağ yapılandırmasını gösterir:

```
NETWORK:↵  
Dynamic IP: true↵  
Static address: 192.168.2.2↵  
Static netmask: 255.255.255.0↵  
Static gateway: 192.168.2.1↵  
Current address: 192.168.1.101↵  
Current netmask: 255.255.255.0↵  
Current gateway: 192.168.1.1↵  
↵
```

Önünde CURRENT ibaresi beliren ağ ayarları, aktif olan TCP/IP ayarlarını gösterir ve salt okunur modundadır. CURRENT ayarları, DYNAMIC IP uyarısına bağlı olarak, DHCP veya Static (Sabit) yapılandırmayı yansıtır.

Ağ Ayarlarının Değiştirilmesi

Ağ, DHCP veya bir sabit yapılandırmanın herhangi birini kullanmak üzere yapılandırılabilir. DHCP'yi etkinleştirmek için:

```
NETWORK:↵  
Dynamic IP: true↵  
↵
```

Sabit bir IP adresi oluşturmak için, tüm sabit parametreleri bildirin, dolayısıyla:

```
NETWORK:↵  
Dynamic IP: false↵  
Static address: 192.168.2.2↵  
Static netmask: 255.255.255.0↵  
Static gateway: 192.168.2.1↵  
↵
```

Önünde CURRENT ibaresi bulunan tüm parametreler salt okunur moddadır ve sabit veya dinamik ayarına bakmaksızın, aktif yapılandırmayı gösterir.

Cihazın adını veya ağ ayarlarından herhangi birini değiştirmek, IP bağlantısının düşmesine sebebiyet verecektir. Cihaz ağ iletişimini yeniden başlatacaktır ve ağ üzerinde yeni adını ilan edecektir.

Monitör Ayarlarının Değiştirilmesi

Her bir monitör için görüntüleme ayarları ayrı ayrı belirlenir. Parametrelerden biri veya daha fazlası aynı anda değiştirilebilir ve birden fazla ayar tek bir blok kapsamında sunulabilir.

Sayısal değerler için geçerli aralık 0 ila 255 arasındadır. CONTRAST (kontrast) ve SATURATION (doygunluk) özellikleri sıfır merkezlidir. Böylelikle normal değeri 127'dir, öyle ki görüntülenen görüntü orijinaliyle aynıdır. Kanalların herhangi birinde 127'den daha yüksek olan bir değer, kontrast veya doygunluğun artmasına sebep olur. Aynı şekilde, 127'den daha düşük bir değer de bir artışa yol açacaktır.

Örneğin, parlaklığı %50'ye ayarlayarak görüntünün doygunluğunu Siyah & Beyaz'a getirmek için:

```
MONITOR A:↵  
Brightness: 127↵  
Saturation: 0↵  
↵
```

16:9'da SD Görüntüleme

Aşağıdaki komut, standart tanımlı video'nun 16:9'da görüntülenmesini sağlar:

```
MONITOR A:↵  
WidescreenSD: ON↵
```

4:3'te SD Görüntüleme

Aşağıdaki komut, standart tanımlı video'nun 4:3'te görüntülenmesini sağlar:

```
MONITOR A:↵  
WidescreenSD: OFF↵
```

Belirleme ve Tally Ayarları

'Identify' (Belirle) uyarısı geçicidir ve 15 saniyelik bir süre boyunca görüntünün tamamının çevresinde beyaz bir çerçeve sergilenmesini sağlar. Bu süreden sonra, yeniden ayarlanır. Bu özellik, içinde birden fazla ünitenin bulunduğu bir rack'e montajlandığı durumlarda, hali hazırda hangi monitörün yapılandırıldığını belirlemeyi amaçlar. Bu özelliği etkinleştirmek için:

```
MONITOR A:↵  
Identify: true↵  
↵
```

Buna göre, IDENTIFY çerçevesi diğer bütün çerçeve ayarlarını geçici olarak geçersiz kılar.

BORDER (çerçeve) özelliği, yazılım bazlı Tally özelliğinin renkli çerçevelerini ana renklerden birine ayarlamak için, pragmatik olarak kullanılabilir. RED (kırmızı), GREEN (yeşil), BLUE (mavi), WHITE (beyaz) veya NONE (Hiçbiri). Bu ayar, cihazın kendi üzerindeki DB-9 girişinde, elektrikli Tally sinyalleri tarafından geçersiz kılınabilir. Örneğin, yazılım bazlı Tally rengini yeşile ayarlamak için:

```
MONITOR B:↵  
Border: green↵  
↵
```

Fiziksel bağlantısı olan tally, her zaman için yazılım bazlı olanını geçersiz kılacaktır. Eksiksiz durum raporu her zaman, mevcut olan geçerli çerçeveyi gösterecektir.

SmartScope Ayarları

SmartScope Duo 4K'da her bir monitör farklı bir skop görüntülemek üzere ayarlanabilir. Belirli skopları etkinleştirmek için gereken değerler aşağıdaki şekilde eşleştirilmiştir:

AudioDbfs
AudioDbvu
Histogram
ParadeRGB
ParadeYUV
Picture (Bu Video Monitor ile aynıdır)
Vector100
Vector75
WaveformLuma

```
MONITOR A:↵  
ScopeMode: Picture↵  
↵
```

Yukarıdaki örnekte, Monitör A, bir video monitörü olarak ayarlanmıştır.

16:9'da SD Görüntüleme

Standart tanımlı videoyu 16:9 formatında görüntülemek üzere Video Monitor (video monitörü) modunu ayarlamak için:

```
MONITOR A:↵  
ScopeMode: Picture↵  
WidescreenSD: ON↵
```

4:3'te SD Görüntüleme

Standart tanımlı videoyu 4:3 formatında görüntülemek üzere Video Monitor (video monitörü) modunu ayarlamak için:

```
MONITOR A:↵  
ScopeMode: Picture↵  
WidescreenSD: OFF↵
```

SmartScope Duo 4K'nın monitörlerinden birini, ses göstergelerini görüntülemek üzere ayarlarken, ayrıca hangi kanalların gösterilmesini istediğinizi de seçebilirsiniz. Ses kanallarının seçiminde gerekli olan değerler, aşağıdaki şekilde eşleştirilmiştir:

- 0: 1 ve 2 numaralı Kanallar
- 1: 3 ve 4 numaralı Kanallar
- 2: 5 ve 6 numaralı Kanallar
- 3: 7 ve 8 numaralı Kanallar
- 4: 9 ve 10 numaralı Kanallar
- 5: 11 ve 12 numaralı Kanallar
- 6: 13 ve 14 numaralı Kanallar
- 7: 15 ve 16 numaralı Kanallar

```
MONITOR B:↵  
ScopeMode: AudioDbvu↵  
AudioChannel: 0↵
```

↵

Yukarıdaki örnekte, Monitör B, Ses Göstergesini Dbvu modunda görüntülemek üzere ve 1 ile 2 numaralı kanallar da, faz göstergesini görüntülemek üzere seçilmiştir.

SmartView 4K için LUT'ların Seçilmesi

SmartView 4K'yı kullanarak bir 3D LUT seçmek için:

```
MONITOR A:↵  
LUT: 0          LUT 1  
      1          LUT 2  
      NONE      DISABLE
```

↵

↵

Yardıım

Yardıım İin

Yardıım almak iin takip edeceėiniz drt adım vardır.

- 1** En gncel destek notları ve bilgileri iin ltfen www.blackmagicdesign.com/tr/support adresinden, Blackmagic Design destek merkezine bakınız.
- 2** Blackmagic Design satıcınızı arayın.
- 3** Yerel satıř bayiniz, Blackmagic Design'in en son teknik gncellemelerine sahiptir ve size anında yardıım sunabilecektir. Ayrıca, satıř bayinizin sunmuř olduėu destek seeneklerini de gzden geirmenizi neriyoruz nk, iř akıřı gereksinimlerinize baėlı olarak sizin iin eřitli destek dzenlemeleri yapabilirler.
- 4** Bir sonraki seenek ise www.blackmagicdesign.com/tr/support adresinden eriřim saėlayacaėınız, "send us an email" (bize elektronik posta gnderin) butonunu kullanarak, elektronik posta yoluyla bize sorularınızı iletmenizdir.
- 5** Bir Blackmagic Design destek ofisini arayın. Destek sayfasının altındaki "Find your local support team" (yerel destek ekibinizi bulun) butonunu tıklayarak, size en yakın olan ofisi bulabilirsiniz.

Sorunuza en kısa zamanda yanıt verebilmemiz aısından, teknik sorunuz ve sistem zellikleri hakkında, ltfen bize mmkn olduėunca fazla bilgi saėlayınız.

Mevzuata İlişkin Bildirimler

Avrupa Birliği Dahilinde Elektrikli ve Elektronik Cihazlara Dair Atık Kontrol Yönetmeliği.



Ürün üzerindeki sembol, bu cihazın başka atık malzemelerle bertaraf edilmemesi şartını gösterir. Atık ekipmanlarınızı bertaraf edebilmemiz için geri dönüşümünü sağlamak üzere, belirlenmiş toplama noktasına teslim edilmeleri gerekmektedir. Bertaraf anında atık cihazlarınızın ayrı olarak toplanması ve geri dönüşümü, doğal kaynakların korunmasına yardımcı olacaktır ve insan sağlığını ve çevreyi koruyucu bir şekilde geri dönüşümünü sağlayacaktır. Atık ekipmanlarınızı geri dönüşüm için nereye teslim edebileceğiniz konusunda daha fazla bilgi için, lütfen yerel belediyenizin geri dönüşüm şubesini ya da ürünü satın aldığınız satış bayisini arayınız.



Bu cihaz, test edilmiş ve Federal İletişim Komisyonu (FCC) koşullarının 15. bölümü doğrultusunda A Sınıfı dijital cihazların sınırlarıyla uyumlu olduğu tespit edilmiştir. İlgili sınırlar, bu cihaz ticari bir ortamda çalıştırıldığında, zararlı müdahalelere karşı makul koruma sağlamaları amacıyla tasarlanmıştır. Bu cihaz; radyo frekans enerjisi üretir, kullanır ve saçabilir ve talimatlar doğrultusunda kurulmadığı ve kullanılmadığı takdirde, radyo iletişimlerine zararlı müdahaleye yol açabilir. Bu ürünün bir yerleşim bölgesinde çalıştırılması zararlı müdahaleye yol açabilir. Bu durumda, müdahalenin düzeltilmesi için ilgili maliyeti kullanıcı karşılamak zorundadır.

Bu cihazın çalıştırılması, aşağıdaki iki şarta bağlıdır:

- 1 Bu cihaz, zararlı müdahaleye sebebiyet vermemelidir.
- 2 Bu cihaz, arzu edilmeyen bir çalışma şekline yol açacak müdahale de dahil olmak üzere, maruz kaldığı her türlü müdahaleyi kabul etmelidir.

–



MSIP-REM-BMD-201410001
MSIP-REM-BMD-20150327
MSIP-REM-BMD-201702004
MSIP-REM-BMD-201702005

ISED Kanada Beyannamesi



Bu cihaz, A Sınıfı dijital cihazlar için Kanada standartlarıyla uyumludur.

Bu cihaza yapılacak herhangi bir değişiklik veya kullanım amacı dışında kullanılması, bu standartlara uyumluluğunu hükümsüz kılabilir.

HDMI arayüzlerine bağlantı, yüksek kalitedeki korumalı HDMI kablolarıyla yapılmalıdır.

Bu cihaz, ticari ortamda kullanım amacına uygunluk için test edilmiştir. Bu cihaz bir ev ortamında kullanıldığı durumlarda, radyo parazitine neden olabilir.

Güvenlik Bilgileri

Elektrik çarpma riskine karşı korunmak için, bu cihaz koruyucu topraklama bağlantısı olan bir şebeke prizine takılmalıdır. Emin olmadığınız durumlarda yetkili bir elektrik teknisyeni ile irtibata geçiniz.

Elektrik çarpma riskini azaltmak için, bu cihaz damlayan veya sıçrayan suya maruz bırakılmamalıdır.

Ürün, ortam ısı 40° C'ye kadar olan tropikal ortamlarda kullanılmaya uygundur.

Ürünün çevresinde yeterli havalandırma olduğundan ve hava akımının kısıtlanmadığından emin olun.

Rafa monte ederken, bitişik cihazlardan dolayı hava akımının kısıtlanmadığından emin olun.

Ürün içinde, kullanıcı tarafından tamir edilebilecek hiçbir parça bulunmamaktadır. Gerekli tamiratları yerel Blackmagic Design servis merkezine yönlendirin.

Bazı ürünlere küçük form-faktörlü alıcı-verici (SFP) optik fiber modülleri takılabilir. Yalnızca 1. sınıf Lazer optik SFP modüllerini kullanın.

Tavsiye edilen Blackmagic Design SFP modülleri:

- **3G-SDI:** PL-4F20-311C
- **6G-SDI:** PL-8F10-311C
- **12G-SDI:** PL-TG10-311C



Deniz seviyesinden yüksekliği 2000m'yi aşmadığı yerlerde kullanın.

Kaliforniya Eyalet Beyannamesi

Bu ürün; plastik parçaları dahilinde, eser miktarda polibromine bifeniller gibi kimyasal maddelere sizi maruz bırakabilir. Kaliforniya eyaletinde, bu maddelerin kansere, doğum kusurlarına veya başka üreme bozukluklarına sebebiyet verdiği bilinmektedir.

Daha fazla bilgi için, www.P65Warnings.ca.gov adresini ziyaret ediniz.

Garanti

12 Ay Sınırlı Garanti

Blackmagic Design şirketi, bu ürünün satın alındığı tarihten itibaren malzeme ve işçilik bakımından 12 ay boyunca kusursuz ve arızasız olacağını garanti eder. Üründe bu garanti süresi içinde bir arıza ve kusur söz konusu olursa Blackmagic Design, kendi seçimi doğrultusunda, ya arızalı ürünü parça ve işçilik bedeli talep etmeksizin tamir edecektir ya da arızalı ürünü, yenisiyle değiştirecektir.

Bu garanti kapsamı altında hizmetten yararlanmak için müşterilerimiz, Blackmagic Design'ı arızaya ilişkin garanti süresi sona ermeden bilgilendirmelidir ve söz konusu hizmetin sağlanması için uygun düzenlemeleri yapmalıdır. Blackmagic Design tarafından özel belirlenmiş ve yetkilendirilmiş bir hizmet merkezine, arızalı ürünün ambalajlanarak sevkiyatı, Müşterilerimizin sorumluluğudur ve sevkiyat ücretleri peşin ödenmiş olmalıdır. Herhangi bir sebepten dolayı bize iade edilen ürünlerin; tüm nakliye, sigorta, yasal bedel, vergi ve diğer tüm masrafların ödenmesi müşterinin sorumluluğu altındadır.

Bu garanti; yanlış kullanım ya da yanlış veya kusurlu tamir ve bakımdan kaynaklanan herhangi bir arızayı, bozukluğu ya da hasarı kapsamaz. Blackmagic Design burada açıklanan durumlarda, bu garanti kapsamında hizmet sağlamak zorunda değildir: a) Blackmagic Design temsilcileri haricindeki başka personelin ürünü kurma, tamir etme ya da bakımını yapma girişimlerinden kaynaklanan hasarın tamir edilmesi, b) uygun olmayan kullanım veya uyumlu olmayan ekipmanlara bağlanmasından kaynaklanan hasarın tamir edilmesi, c) Blackmagic Design parçaları ya da malzemesi olmayan ürünlerin kullanımından kaynaklanan hasarın ya da arızanın tamir edilmesi ya da d) Modifiye veya başka ürünlerle entegre edilmiş bir ürünün; söz konusu modifikasyon ya da entegrasyonun gereken tamiratın süresini uzattığı ya da ürün bakımını zorlaştırdığı durumlarda, tamir edilmesi. BU GARANTİ, BLACKMAGIC DESIGN TARAFINDAN VERİLMİŞTİR VE AÇIK YA DA ZİMNİ, HERHANGİ BİR GARANTİNİN YERİNİ TUTAR. BLACKMAGIC DESIGN VE SATICILARI, ZİMNİ TİCARİ UYGUNLUK GARANTİSİNİ YA DA ÖZEL BİR AMACA UYGUNLUK GARANTİSİNİ KABUL ETMEZ. KUSURLU BİR ÜRÜNÜN TAMİRİ VEYA DEĞİŞTİRİLMESİ, BLACKMAGIC DESIGN'IN MÜŞTERİLERİNE SUNDUĞU TAM VE MÜNHASİR ÇÖZÜMDÜR. BLACKMAGIC DESIGN YA DA SATICILARININ OLABİLECEK HASARLAR HAKKINDA ÖNCEDEDEN BİLGİSİ OLMASINI GÖZETMEKSİZİN, ÜRÜNDE DOLAYLI, ÖZEL, TESADÜFİ YA DA NETİCE OLARAK ORTAYA ÇIKAN HERHANGİ BİR HASAR İÇİN, BLACKMAGIC DESIGN SORUMLU DEĞİLDİR. BLACKMAGIC DESIGN, MÜŞTERİLER TARAFINDAN EKİPMANIN YASAL OLMAYAN HERHANGİ BİR KULLANIMINDAN SORUMLU DEĞİLDİR. BLACKMAGIC DESIGN, BU ÜRÜNÜN KULLANIMINDAN KAYNAKLANAN HERHANGİ BİR HASARDAN SORUMLU DEĞİLDİR. BU ÜRÜNÜN ÇALIŞTIRILMASINDAN DOĞAN RİSK, KULLANICININ KENDİSİNE AİTTİR.

© Telif Hakkı Saklıdır 2020 Blackmagic Design. Tüm Hakları Saklıdır. 'Blackmagic Design', 'DeckLink', 'HDLink', 'Workgroup Videohub', 'Multibridge Pro', 'Multibridge Extreme', 'Intensity' ve 'Leading the creative video revolution', ABD ve diğer ülkelerde tescil edilmiş ticari markalardır. Diğer tüm şirket ve ürün isimleri bağlantılı oldukları ilgili şirketler/firmaların ticari markaları olabilir.